



THE 5

SALOON

THE BMW 5 SERIES SALOON.



18 Highlights

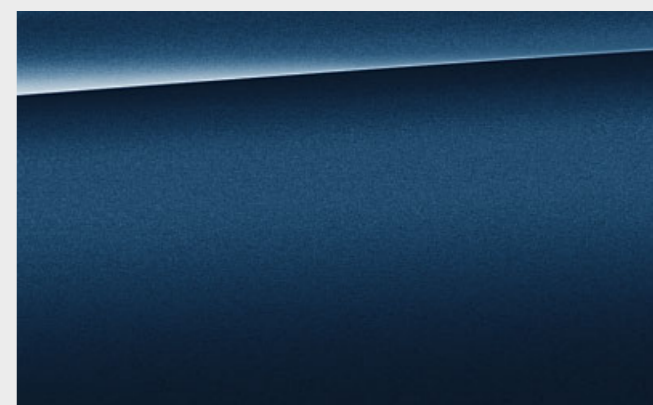

20 Worlds of colour



24 Wheels and tyres / Original BMW Accessories and BMW M Performance Parts

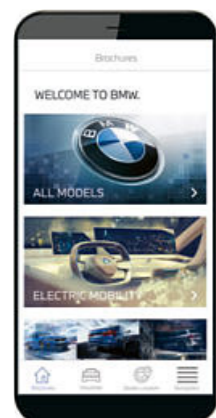

YOUR BMW BROCHURES APP.

DOWNLOAD NOW THE BMW BROCHURES APP FROM YOUR APP STORE AND DISCOVER DRIVING PLEASURE!

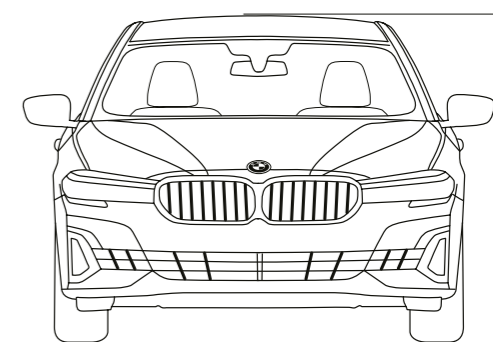

26 Technical data



LEADING
WITH STYLE.



RUNS WITH
ALTERNATIVE
ENERGY:
ADRENALINE.



FACE
FORWARD.





BUILT-IN
EXTRAORDINARY.



FORM
FOLLOWS
FASCINATION.



REACH YOUR GOALS
ON THE ROAD.
THE BMW 5 SERIES SALOON.



Discover even more with the new BMW Brochures app. Available now, for your smartphone and tablet.

■ Standard equipment □ Optional equipment



□ The M Sport package gives the vehicle an even sportier touch. In addition to an appearance sharpened by many details in the exterior and interior, the M Sport package guarantees an increase in driving pleasure. The M Sport suspension* and the M Aerodynamics package for example noticeably optimise the driving dynamics.



□ The Luxury Line shows the elegant side of the vehicle. Elegant design elements made of Chrome high-gloss give the exterior its exclusive appearance. The stylish impression is also present in the interior. Here first-class leather upholstery and high-quality interior trim finishers characterise luxury.



□ Do you want your BMW to be up to date with the latest software? With Remote Software Upgrade*, your BMW will always be up to date. Upgrades are installed over the air, just as they are for your smartphone. In this way, other functions in your vehicle can also be activated.



□ The comfort seats for driver and front passenger* include active headrests and can be electrically adjusted in various ways. The top part of the backrest, the backrest width, thigh support and headrest height can be individually adjusted. The equipment package also includes the lumbar support and memory function for the driver and front passenger.



□ BMW Individual high-gloss Shadow Line with extended contents¹ includes equipment features in black: Kidney grille frame and kidney grille slats in black high-gloss and tailpipe trims in Black Chrome.



□ In laser high-beam mode, BMW Laserlight* illuminates a range of up to 650 m, nearly twice as far as that of conventional headlights. Better visibility in the dark significantly increases safety. Blue accents and the lettering "BMW Laser" in the headlight also underline the technological standards and the sportiness of the vehicle.



□ The high-performance M Sport brake* is distinguished by exclusive red high-gloss brake callipers with M designation and outstanding braking performance.



□ Your vehicle key? No need for that anymore. The Digital Key³* exists on your smartphone, and you can share it with friends.



□ BMW Live Cockpit Professional* includes two high-quality displays consisting of a 12.3" Control Display and a fully digital 12.3" instrument display.

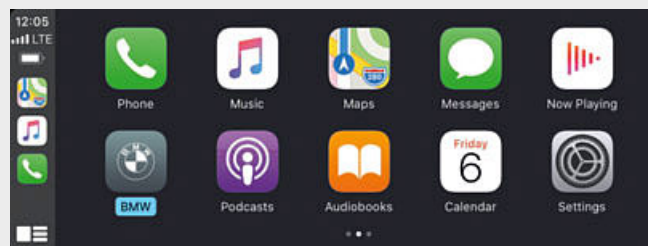

□ Why go without the features of your smartphone in your BMW when you can continue operating it as usual? With smartphone integration²*, your vehicle supports Apple CarPlay and Android Auto by means of a wireless connection between your smartphone and the vehicle. This allows you to conveniently use familiar functions and various apps in the vehicle.



□ The Reversing Assistant* stores the last 50 m of the driven path in forward travel up to 35 km/h, so that it can be retracted if required. You are relieved of the steering work and can concentrate on monitoring the vehicle environment.

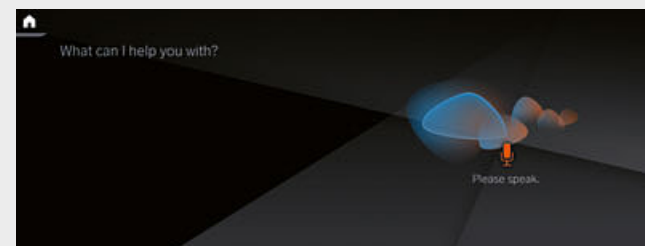

□ "Hey BMW. Who are you?" Wouldn't it be incredible if your BMW was also your personal assistant? Communicate with your vehicle using the BMW Intelligent Personal Assistant*. It knows you, gets better every day and helps out whatever the situation. You also can assign your own personal activation word. It can explain everything about your vehicle and helps you to get to know your BMW even better.



□ Driving Assistant Professional⁴* offers optimum comfort and safety during critical or monotonous traffic situations. Apart from the contents of the Driving Assistant, it also includes Steering and Lane Control Assistant with extended functions, Emergency Stop Assistant and Lane Keeping Assistant with active side collision protection.

¹ Only available for M550i xDrive and M Sport package.

² Smartphone integration is permanently available in the vehicle. It includes Apple CarPlay and Android Auto. Due to possible future technical developments (e.g. of mobile phones),

the usability of the Apple CarPlay or Google Android Auto service cannot be guaranteed permanently. CarPlay is a trademark of Apple Inc. Android Auto is a trademark of Google LLC.

³ Prerequisite is a BMW ConnectedDrive account and a compatible smartphone. For customers with a non-compatible smartphone, a high-quality Key Card is provided. More information about the BMW Digital Key, e.g. regarding the compatibility of your smartphone, is available at www.bmw.com/digitalkey

⁴ Function may be limited in darkness, fog or bright glare.

* The availability of some equipment features and functions depends on engine variants or additional options. The market and production availability may vary. You can find detailed information about terms, standard and optional equipment at www.bmw.com or at your BMW Partner. Some ConnectedDrive Services may differ between countries. Please consult your local BMW partner for more information.

EXTERIOR COLOURS.

Discover even more with the new BMW Brochures app. Available now, for your smartphone and tablet.

■ Standard equipment □ Optional equipment



□ Non-metallic 300 Alpine White¹

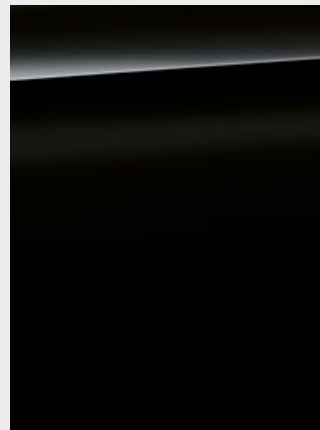

■ Non-metallic 668 Black



□ Metallic A96 Mineral White



□ Metallic A83 Glacier Silver



□ Metallic C2Y Bluestone²



□ Metallic C3E Bernina Grey Amber Effect²



□ Metallic A90 Sophisto Grey Brilliant Effect²



□ Metallic 475 Black Sapphire²



□ Metallic C1M Phytionic Blue²

BMW INDIVIDUAL



□ BMW Individual special paintwork Brilliant White metallic²



□ BMW Individual special paintwork Frozen Brilliant White metallic²



□ BMW Individual special paintwork Pure metal Silver²



□ BMW Individual exclusive colour Cashmere Silver metallic²



□ BMW Individual special paintwork Frozen Dark Silver²



□ BMW Individual C5E Alvite Grey metallic²



□ BMW Individual C3Z Tanzanite Blue metallic²

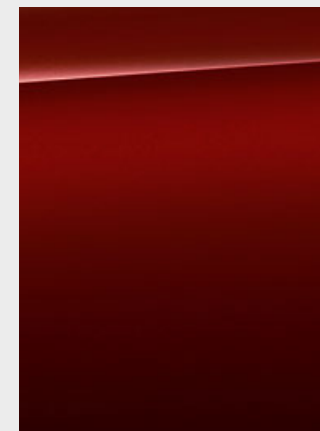

□ BMW Individual X1C Aventurine Red metallic²

M SPORT PACKAGE

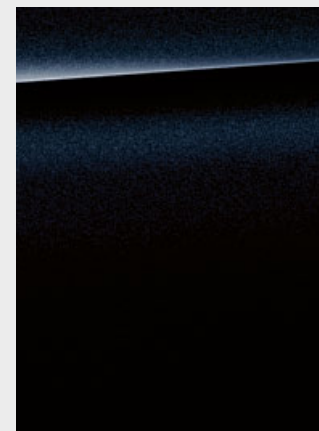

□ Metallic 416 M Carbon Black³

[Colour samples] These colour samples are intended as an initial guide to the colours and materials available for your BMW. However, experience has shown that printed versions of paint, upholstery and interior trim colours cannot in all cases faithfully

reproduce the appearance of the original colour. Please discuss your preferred colour choices with your BMW partner or in your dealership. There you can also see original samples and be assisted with special requests.

¹ Available as standard with the M Sport package and M550i xDrive.
² Optionally also available with the M Sport package and M550i xDrive.
³ Exclusively available with the M Sport package and M550i xDrive.

The availability of some equipment features and functions depends on engine variants or additional options. The market and production availability may vary. You can find detailed information about terms, standard and optional equipment at www.bmw.com or at your BMW Partner.

INTERIOR COLOURS.

Discover even more with the new BMW Brochures app. Available now, for your smartphone and tablet.

■ Standard equipment □ Optional equipment

CLOTH

Available with

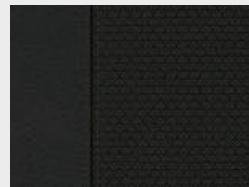

■ Base model

Cloth 'Junction'
BYAT Anthracite

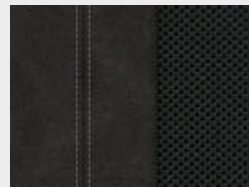

■ M Sport package

Cloth 'Rhombicle'/
Alcantara
HRAT Anthracite

LEATHER

Available with

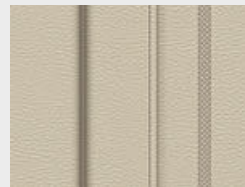

□ Base model
□ Luxury Line
□ M Sport package

Leather 'Dakota'
LCFI Ivory White
exclusive stitching/
leather piping in
contrast



□ Base model
□ Luxury Line
□ M Sport package

Leather 'Dakota'
LCRO Cognac exclusive
stitching/leather piping
in contrast



□ Base model
■ Luxury Line
□ M Sport package

Leather 'Dakota' LCFK
Black, exclusive
stitching/leather
piping in contrast Black

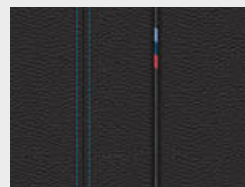

□ M Sport package

Leather 'Dakota'
LCNL Black,
contrast stitching blue

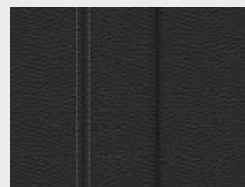

□ Base model
□ Luxury Line
□ M Sport package

Leather 'Dakota'
LCSW Black*

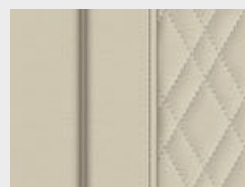

□ Base model
□ Luxury Line
□ M Sport package

Exclusive leather
'Nappa'
LZFI Ivory White
with exclusive
stitching/leather
piping in contrast*

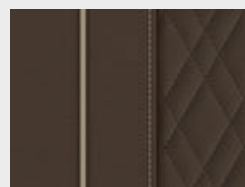

□ Base model
□ Luxury Line
□ M Sport package

Exclusive leather
'Nappa'
LZNI Mocha exclusive
stitching/leather
piping in contrast*

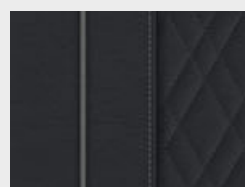

□ Base model
□ Luxury Line
□ M Sport package

Exclusive leather
'Nappa'
LZFK Black exclusive
stitching/leather piping
in contrast*

INTERIOR TRIM FINISHERS

Available with

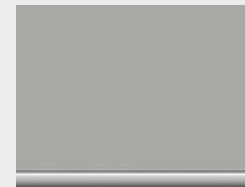

■ Base model

Interior trim finishers
Oxide Silver dark matt
with highlight trim
finisher Pearl Chrome



□ Base model
□ Luxury Line
□ M Sport package

Interior trim finishers
Aluminium fine cutting
with highlight trim
finisher Pearl Chrome



■ M Sport package

Aluminium Rhombicle
Smoke Grey M interior
trim strips with Pearl
Chrome accent trim

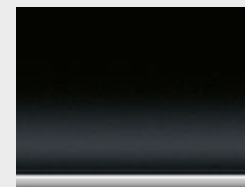

□ Base model
□ Luxury Line

Interior trim finishers
black high-gloss with
highlight trim finisher
Pearl Chrome



□ Base model
□ Luxury Line
□ M Sport package

Fine-wood trim
'Fineline' Cove with
highlight trim finisher
Pearl Chrome

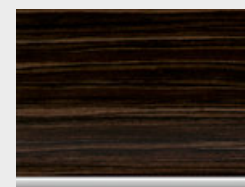

□ Base model
■ Luxury Line
□ M Sport package

Fine-wood trim
'Fineline' Ridge with
highlight trim finisher
Pearl Chrome



□ Base model
□ Luxury Line
□ M Sport package

Fine-wood trim Ash
Trunk open-pored with
highlight trim finisher
Pearl Chrome

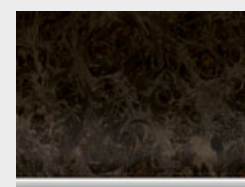

□ Base model
□ Luxury Line
□ M Sport package

Fine-wood trim poplar
grain grey with highlight
trim finisher Pearl
Chrome

BMW INDIVIDUAL LEATHER

Available with

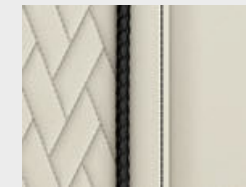

□ Base model
□ Luxury Line
□ M Sport package

BMW Individual full
leather trim 'Merino'
ZBFU Smoke White*

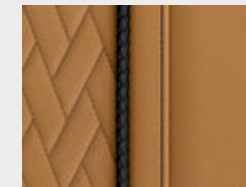

□ Base model
□ Luxury Line
□ M Sport package

BMW Individual full
leather trim 'Merino'
ZBCR Carame!*

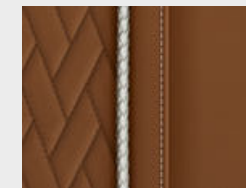

□ Base model
□ Luxury Line
□ M Sport package

BMW Individual full
leather trim 'Merino'
ZBTQ Tartufo*

BMW INDIVIDUAL INTERIOR TRIM FINISHERS

Available with



□ Base model
□ Luxury Line
□ M Sport package

BMW Individual
fine-wood trim Sen light
brown with highlight
trim finisher Pearl
Chrome*

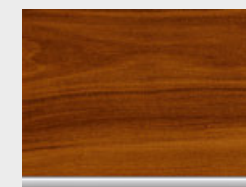

□ Base model
□ Luxury Line
□ M Sport package

BMW Individual
fine-wood trim plum
brown high-gloss with
highlight trim finisher
Pearl Chrome*

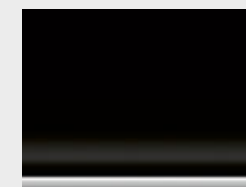

□ Base model
□ Luxury Line
□ M Sport package

BMW Individual interior
trim finishers piano
finish Black with
highlight trim finisher
Pearl Chrome*

Please note that even normal long- or short-term use can lead to unrecoverable upholstery damage. This can be caused in particular by non-colourfast clothing.

Please note that the interior colour depends on the selected upholstery colour.

* The availability of some equipment features and functions depends on engine variants or additional options. The market and production availability may vary.

You can find detailed information about terms, standard and optional equipment at www.bmw.com or at your BMW Partner.

WHEELS AND TYRES.

Discover even more with the new BMW Brochures app. Available now, for your smartphone and tablet.



□ 18" light alloy wheels Multi-spoke style 619, 8J x 18 with 245/45 R18 tyres.



□ 18" light alloy wheels W-spoke style 632, size 8J x 18 with 245/45 R18 tyres.¹



□ 18" M light alloy wheels Double-spoke style 662 M Orbit Grey with mixed tyres, gloss-lathed, wheel size front 8J x 18 with 245/45 R18 tyres, wheel size rear 9J x 18 with 275/40 R18 tyres.²



□ 19" light alloy wheels Multi-spoke style 633, 8J x 19 with 245/40 R19 tyres.¹



□ 19" light alloy wheels V-spoke style 635 Ferric Grey gloss-lathed with mixed tyres and run-flat properties, front 8J x 19 with 245/40 R19 tyres, rear 9J x 19 with 275/35 R19 tyres.



□ 19" light alloy wheels W-spoke style 663 Ferric Grey gloss-lathed with mixed tyres and run-flat properties, front 8J x 19 with 245/40 R19 tyres, rear 9J x 19 with 275/35 R19 tyres.



□ 19" M light alloy wheels Y-spoke style 845 M Bicolour Jet Black with mixed tyres, gloss-lathed, wheel size front 8J x 19 with 245/40 R19 tyres, wheel size rear 9J x 19 with 275/35 R19 tyres.²



□ 19" M light alloy wheels Y-spoke style 845 M Jet Black with mixed tyres, wheel size front 8J x 19 with 245/40 R19 tyres, wheel size rear 9J x 19 with 275/35 R19 tyres.²



□ 20" M light alloy wheels Double-spoke style 668 M Cerium Grey matt with mixed tyres and runflat tyres, gloss-lathed, wheel size front 8J x 20 with 245/35 R20 tyres, wheel size rear 9J x 20 with 275/30 R20 tyres.³



□ 20" M light alloy wheels Y-spoke style 846 M Bicolour Jet Black with mixed tyres and run-flat tyres, gloss-lathed, wheel size front 8J x 20 with 245/35 R20 tyres, wheel size rear 9J x 20 with 275/30 R20 tyres.⁴



□ 20" BMW Individual aerodynamic wheels 1001 I Jet Black 3D buffed with mixed tyres and run-flat tyres, gloss-lathed, wheel size front 8J x 20 with 245/35 R20 tyres, wheel size rear 9J x 20 with 275/30 R20 tyres.

ORIGINAL BMW ACCESSORIES AND BMW M PERFORMANCE PARTS.

■ Standard equipment □ Optional equipment ○ Accessories



○ Thanks to the BMW wireless charging station universal, the smartphone can be charged comfortably without a cable – even outside the vehicle.



○ In the event of disturbances, the highly sensitive full-HD camera automatically records the situation in front of and behind the car.

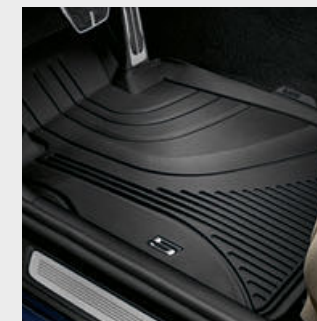

○ Precisely fitted protection against moisture and dirt in the front footwell. The black design perfectly complements the interior.

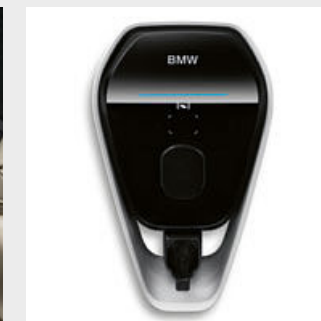

○ Like a filling station right in your own home: With the BMW Wallbox Plus, you can charge your BMW quickly, reliably and conveniently in a few hours. You also have the option to manage the use of the BMW Wallbox Plus with an access card.



○ Make a strong statement: The carbon fibre M Performance front splitters provide optimum aerodynamics and highlight the vehicle's masculine appearance in a highly exclusive manner. A unique motorsport look for anybody who refuses to compromise.



○ Show your style: the frame of the M Performance kidney grille is made of hand-crafted premium carbon fibre and the grille consist of extra sturdy plastic. A visual highlight at the front of the vehicle for an especially elegant, sporty and individual look.



○ The striking carbon-fibre M Performance exterior mirror caps highlight the vehicle's high-tech character, adding an individual athletic touch.



○ The M Performance kidney grilles Iconic Glow give the vehicle a unique radiance. LED lighting exclusively sets the scene for the BMW kidney grille and the zone in front of the vehicle from opening to starting and from switching off the ignition to locking the vehicle.



○ Gripping facts: The sport-style steering wheel with Alcantara-lined grip area provides excellent feel and grip for a more direct and responsive steering feel.

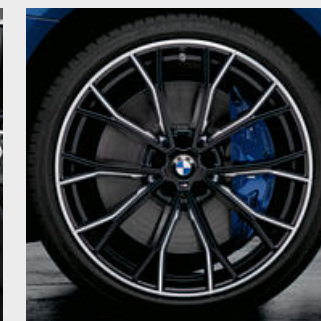

○ 20" M Performance light alloy wheels, forged, in Bicolor Black matt, milled and gloss-lathed on the visible side. Complete wheel set with run-flat tyres.

¹ Only available in conjunction with Luxury Line.
² Only available in conjunction with M Sport package.

³ Only available for M550i xDrive.
⁴ Only available for M550i xDrive and M Sport package.

Discover the wide range of innovative solutions available for the exterior and interior, communication and information, and for transportation and the luggage compartment. Your BMW Partner is on hand to advise you on the whole range of Original BMW Accessories and the BMW M Performance Parts product portfolio. For further information, please visit www.bmw.com

The availability of some equipment features and functions depends on engine variants or additional options. The market and production availability may vary. You can find detailed information about terms, standard and optional equipment at www.bmw.com or at your BMW Partner.

BMW 5 Saloon	520i ¹¹	520i ¹¹ with mild hybrid technology	530i ¹¹ xDrive ¹¹ with mild hybrid technology	540i ¹¹ xDrive ¹¹ with mild hybrid technology	M550i xDrive	518d ¹¹ with mild hybrid technology	520d ¹¹ 520d xDrive ¹¹ with mild hybrid technology	530d ¹¹ 530d xDrive ¹¹ with mild hybrid technology	540d xDrive ¹¹ with mild hybrid technology	520e	530e 530e xDrive	545e xDrive
--------------	--------------------	--	--	--	--------------	--	---	---	---	------	---------------------	-------------

Weight													
Unladen weight EU (xDrive) ¹	kg	1655	1685	1700 (1755)	1760 (1820)	(1990)	1745	1750 (1810)	1835 (1895)	(1925)	1910	1910 (1970)	(2020)
Max. permissible weight (xDrive)	kg	2250	2285	2305 (2360)	2395 (2455)	(2560)	2340	2345 (2405)	2440 (2505)	(2525)	2505	2505 (2560)	(2605)
Permitted load (xDrive)	kg	670	675	680 (680)	710 (710)	(645)	670	670 (670)	680 (685)	(675)	670	670 (665)	(660)
Permitted trailer load, unbraked (xDrive) ²	kg	750	750	750 (750)	750 (750)	(750)	750	750 (750)	750 (750)	(750)	750	750 (750)	(750)
Permitted trailer load, braked, max. 12 % gradient 8 % gradient (xDrive) ²	kg	2000/2000	2000/2000	2000/2000 (2000/2000)	2000/2000 (2000/2000)	(2000/2000)	2000/2000	2000/2000 (2000/2000)	2000/2000 (2000/2000)	(2000/2000)	1700/1700	1700/1700 (2000/2000)	(2000/2000)
Luggage capacity	l	530	530	530	530	530	530	530	530	410	410	410	

BMW TwinPower Turbo engine ³													
Cylinders/valves	-	4/4	4/4	4/4	6/4	8/4	4/4	4/4	6/4	6/4	4/4	4/4	6/4
Capacity	cm ³	1597	1998	1998	2998	4395	1995	1995	2993	2993	1998	1998	2998
Max. output/ engine speed	kW (hp)/ rpm	125 (170)/ 5000-5500	135-120 (184-163)/ 5000-6500	185 (252)/ 5200-6500	245 (333)/ 5500-6250	390 (530)/ 5500-6000	110-100 (150-136)/ 4000	140-120 (190-163)/ 4000	210-183 (286-249)/ 4000, 3250-4400	250 (340)/ 4400	120 (163)/ 5000-6500	135-120 (184-163)/ 5000-6500	210 (286)/ 5000-6000
With mild hybrid technology	kW (hp)	-	+8 (11)	+8 (11)	+8 (11)	-	+8 (11)	+8 (11)	+8 (11)	-	-	-	
Max. torque/ engine speed	Nm/rpm	250/ 2000-4400	290/ 1350-4250	350/ 1450-4800	450/ 1600-4800	750/ 1800-4600	350/ 1750-2500	400/ 1750-2500	650/ 1500-2500	700/ 1750-2250	300/ 1350-3700	300/ 1350-4000	450/ 1600-3500

eDrive motor												
Peak output	kW (hp)	-	-	-	-	-	-	-	-	80 (109)	80 (109)	80 (109)
Max. torque	Nm	-	-	-	-	-	-	-	-	265	265	265
System output	kW (hp)	-	-	-	-	-	-	-	-	150 (204)	215-200 (292-272)	290 (394)
System torque	Nm	-	-	-	-	-	-	-	-	350	420	600

Lithium-ion high-voltage battery												
Battery type/net battery capacity	kWh	-	-	-	-	-	-	-	-	Li-ion/11.15	Li-ion/11.15	Li-ion/11.15
Electric range (EAER) ^{4,5} (xDrive)	km	-	-	-	-	-	-	-	-	61-53	61-52 (55-47)	(57-47)
Electric range urban (EAER city) ^{4,5} (xDrive)	km	-	-	-	-	-	-	-	-	63-54	63-53 (55-52)	(59-51)
Charging time (AC rapid charging with BMW Wallbox) ⁶	h	-	-	-	-	-	-	-	-	approx. 3.6	approx. 3.6	approx. 3.6

Power transmission													
Type of drive (xDrive)	-	Rear-wheel	Rear-wheel	Rear-wheel (All-wheel)	Rear-wheel (All-wheel)	(All-wheel)	Rear-wheel	Rear-wheel (All-wheel)	Rear-wheel (All-wheel)	All-wheel	Rear-wheel	Rear-wheel (All-wheel)	All-wheel
Standard transmission (xDrive)	-	8-speed Steptronic	8-speed Steptronic	8-speed Steptronic (8-speed Steptronic)	8-speed Steptronic (8-speed Steptronic)	(8-speed Steptronic Sport)	8-speed Steptronic	8-speed Steptronic (8-speed Steptronic)	8-speed Steptronic (8-speed Steptronic)	(8-speed Steptronic)	8-speed Steptronic	8-speed Steptronic (8-speed Steptronic)	(8-speed Steptronic)

Driving performance													
Top speed (xDrive)	km/h	226	235-226	250 ¹⁰ (250) ¹⁰	250 ¹⁰ (250) ¹⁰	(250) ¹⁰	220-212	235-223 (232)	250 ¹⁰ (250) ¹⁰	(250) ¹⁰	225	235 (230-220)	(250) ¹⁰
Top electric speed	km/h	-	-	-	-	-	-	-	-	-	140	140 (140)	(140)
Acceleration 0-100 km/h (xDrive)	s	8.3	7.9-8.6	6.4 (6.3)	5.2 (4.9)	(3.8)	8.8-9.4	7.2-8.2 (7.2)	5.6-5.8 (5.4-5.6)	(4.6)	7.9	5.9 (5.9-6.4)	(4.6)

	520i ¹¹	520i ¹¹ with mild hybrid technology	530i ¹¹ 530i xDrive ¹¹ with mild hybrid technology	540i ¹¹ 540i xDrive ¹¹ with mild hybrid technology	M550i xDrive	518d ¹¹ with mild hybrid technology	520d ¹¹ 520d xDrive ¹¹ with mild hybrid technology	530d ¹¹ 530d xDrive ¹¹ with mild hybrid technology	540d xDrive ¹¹ with mild hybrid technology	520e	530e 530e xDrive	545e xDrive
--	--------------------	--	---	---	--------------	--	---	---	---	------	---------------------	-------------

Consumption ⁷⁻⁹ - All engines conform to the EU6 standard													
Combined (PHEV weighted) (xDrive)	l/100 km	- ¹²	6.1-7.1	6.3-7.2 (6.7-7.5)	7.0-8.0 (7.5-8.4)	(10.3-11.0)	- ¹²	4.7-5.6 (5.0-5.8)	5.1-5.8 (5.4-6.2)	(5.5-6.4)	- ¹²	1.3-1.8 (1.6-2.2)	(1.6-2.2)
Energy consumption (ECAC weighted) ^{8,9} (xDrive)	kWh/ 100 km	-	-	-	-	-	-	-	-	- ¹²	22.1-24.2 (22.2-24.8)	(23.1-25.9)	
Exhaust emissions standard (type-certified)	-	EU6d	EU6d	EU6d	EU6d	EU6d	EU6d	EU6d	EU6d	EU6d	EU6d	EU6d	
Combined CO ₂ emissions (PHEV weighted) (xDrive)	g/km	- ¹²	140-161	143-163 (151-171)	160-182 (170-191)	(235-250)	- ¹²	124-145 (131-152)	133-153 (141-161)	(145-167)	- ¹²	30-42 (36-49)	(37-51)
Tank capacity, approx.	l	68	68	68	68	68	66	66	66	46	46	46	

Wheels/tyres												
Tyre dimensions		225/55 R17 Y	225/55 R17 Y	225/55 R17 Y	225/55 R17 Y	245/40 R19 Y 275/35 R19 Y	225/55 R17 Y	225/55 R17 Y	225/55 R17 Y	225/55 R17 Y	225/55 R17 Y	225/55 R17 Y
Wheel size		7.5 J x 17	7.5 J x 17	7.5 J x 17	7.5 J x 17	8 J x 19 9 J x 19	7.5 J x 17	7.5 J x 17	7.5 J x 17	7.5 J x 17	7.5 J x 17	7.5 J x 17
Material		Light alloy	Light alloy	Light alloy	Light alloy	Light alloy	Light alloy	Light alloy	Light alloy	Light alloy	Light alloy	Light alloy

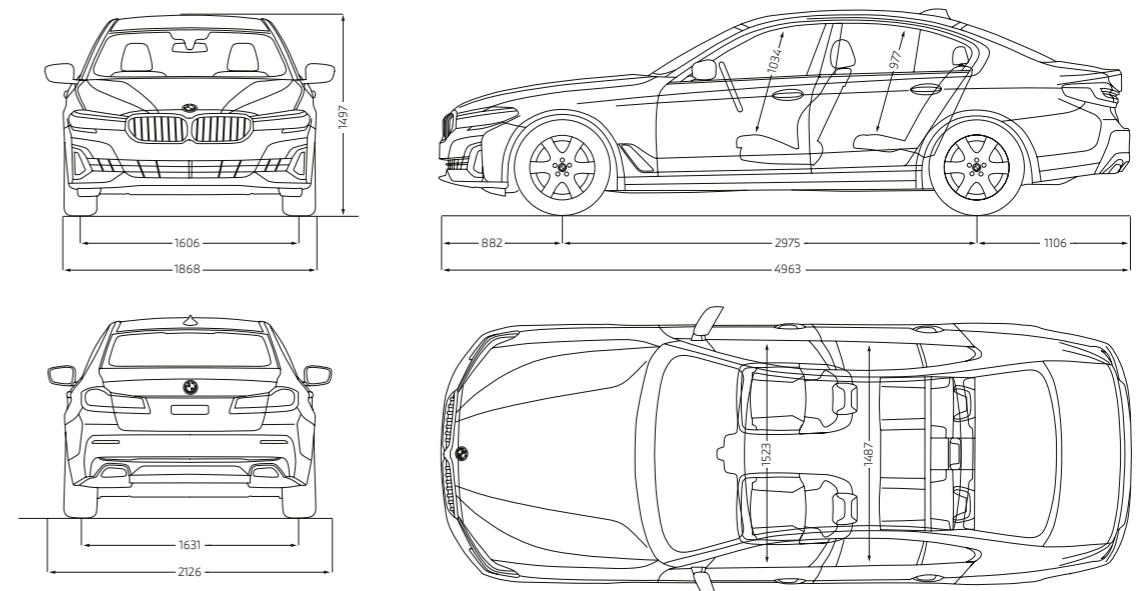

All dimensions in the technical drawing are given in millimetres. The dimensions for M550i xDrive may vary.

The figures for performance, fuel consumption and CO₂ emissions refer to vehicles with standard transmission.

¹ The EC unladen weight refers to a vehicle with standard equipment and does not include any optional extras. The unladen weight includes a 90% full tank and a driver weight of 75 kg. Optional equipment may affect the weight of the vehicle, the payload and the top speed if the selected equipment has an impact on the vehicle's aerodynamics.

² The actual total weight of the trailer must not exceed the maximum trailer load, taking into account the maximum tow bar download.

³ Performance data of petrol engines apply to vehicles using RON 910 fuel. Fuel consumption data apply to vehicles using reference fuels in accordance with EU Regulation 2007/715. Unleaded RON 91 and higher with a maximum ethanol content of 10% (E10) may also be used. BMW recommends RON 95 super unleaded petrol.

⁴ Range depends on the equipment and various factors. In particular: personal driving style, route characteristics, exterior temperature, heating/air conditioning, pre-conditioning and the chosen equipment.

⁵ EAER (equivalent all electric range).

⁶ Dependent on the local electricity infrastructure. Charging time corresponds to a charge of 100% of maximum capacity.

⁷ The data for fuel consumption, CO₂ emissions and energy consumption are determined in accordance with the measurements processes as defined by European Regulation (EU) 715/2007 in the applicable version. Data refer to a vehicle with base-level equipment in Germany, and the ranges account for differences according to the selected wheel and tyre size and the optional equipment. For these vehicles, values other than those specified here may apply for the assessment of taxes and other vehicle-related charges that are (also) based on CO₂ emissions. Version 01/04/2021

⁸ The combined energy consumption depends on the selected wheel and tyre sizes.

⁹ ECAC (charge-depleting electric consumption).

¹⁰ Electronically limited.

¹¹ This engine version is not available in all countries. For further information, please contact your local BMW Partner.

¹² Provisional figures; any missing figures were unavailable at the time of publication.



YOUR BMW BROCHURES APP.

DOWNLOAD NOW THE BMW BROCHURES APP FROM YOUR APP STORE AND DISCOVER DRIVING PLEASURE!

BMW 530e SALOON WITH M SPORT PACKAGE:

BMW TwinPower Turbo 4-cylinder petrol engine + eDrive electric motor, 215 kW (292 hp) system output, 20" M light alloy wheels Y-spoke style 846 M Bicolour Jet Black with mixed tyres, exterior colour in Phytonic Blue metallic, BMW Laserlight, instrument panel in Sensatec, comfort seats in exclusive leather 'Nappa' Ivory White exclusive stitching/leather piping in contrast Black, interior trim finishers Aluminium Rhombicle Smoke Grey with highlight trim finisher Pearl Chrome.

The models illustrated in this medium show the equipment and configuration options (standard and optional) for vehicles produced by BMW AG for the German market. Alterations in standard and optional equipment and the configurations available for the different models, as described in this medium, may occur after 11/11/2020, the editorial deadline for this medium, or according to the specific requirements of other member states of the European Union. Your local BMW Partner is available to provide further details. Subject to change in design and equipment.

Of course, each vehicle is designed for economical recycling after its long-running life. You can find more information regarding your end-of-life vehicle on our website www.bmw.de/recycling
 © BMW AG, Munich, Germany. Not to be reproduced wholly or in part without prior written permission of BMW AG, Munich.