



T H E

THE BMW 1 SERIES.



YOUR WORLD.
My BMW.

Try it out for yourself and install the My BMW App from your Google play or App Store.





18 Highlights



20 Worlds of colour



24 Wheels and tyres / BMW M Performance Parts

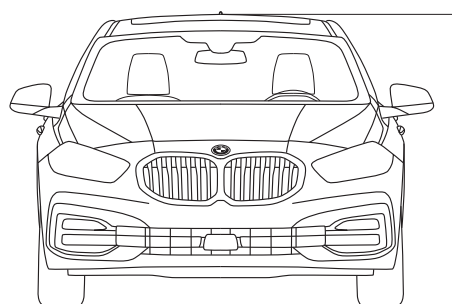

26 Technical data



EYE CANDY TO GO.







TURN YOUR BACK ON BORING.

LOOK, BUT PLEASE TOUCH.









YOU MIGHT WANT TO SIT DOWN FOR THIS.





CONNECTIONS
ARE
EVERYTHING.





TAKE THE LONG
WAY HOME – THEY’LL
UNDERSTAND.
THE BMW 1 SERIES.





HIGHLIGHTS.

Discover even more with the new BMW Products app. Available now, for your smartphone and tablet.



□ The M Sport package gives the vehicle an even sportier touch. In addition to an appearance sharpened by many details in the exterior and interior, the M sports package guarantees an increase in driving pleasure. The M Sport suspension and the M Aerodynamics package for example noticeably optimise the driving dynamics.



□ The M sports seats* with integrated headrests, deep sitting surface and high side and backrest bolsters offer the driver and front passenger improved support, even in fast turns. In addition, the seat can be adjusted to your individual body size thanks to the integrated backrest width adjustment.



□ When open, the Panorama glass roof provides a great deal of fresh air. Closed, it creates a bright, light-flooded atmosphere in the interior. It opens and closes completely automatically at the push of a button or with the vehicle key and is equipped with slide and lift functions, a roller sunblind and wind deflector.



□ The BMW Live Cockpit Professional with navigation function includes two high-quality displays consisting of a high-resolution 10.25" Control Display that can be operated by touch and a fully digital 10.25" instrument display. The BMW Operating System 7 can also be operated via the iDrive Touch Controller.

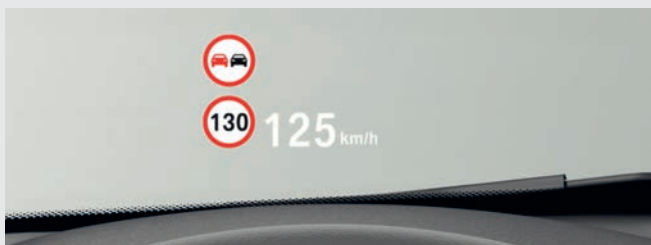

□ The large, full-colour BMW Head-Up Display¹* projects information relevant to the journey directly into the driver's field of vision.

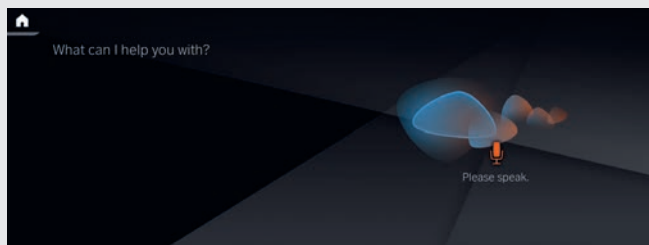

□ Wouldn't it be incredible if your BMW was also your personal vehicle expert? Communicate with your vehicle using the BMW Intelligent Personal Assistant*. Say natural commands to operate numerous vehicle functions. It can also explain topics about your vehicle and helps you to get to know your BMW even better.

¹ The information in the BMW Head-Up Display is not fully visible when viewed through polarised sunglasses. Content shown will depend on the equipment options chosen. Further optional equipment is required to display specific items.

² Function may be limited in darkness, fog or bright glare.

■ Standard equipment □ Optional equipment



■ Its striking appearance and technical details make the BMW 128ti a particularly sporty representative of the model range. Matching its striking model-specific design elements, its petrol engine with BMW TwinPower Turbo technology and the differential lock on the front axle ensure driving dynamics of the highest standard.



□ Interior trim finishes 'Illuminated Boston' with 'Mesh' accent on the instrument panel and door panel.*



□ The M Sport suspension is set approximately 10 mm lower and features more athletic settings.



□ Adaptive LED headlights with low-beam and high-beam headlights include LED turn indicators and Adaptive headlights.

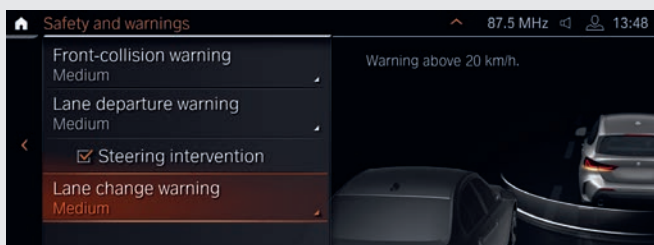

□ The safety package Driving Assistant²* includes the camera-based systems front collision warning with braking function, Speed Limit Assist incl. Speed Limit Info with No-overtaking indicator with preview and Lane Departure Warning. Additionally, the radar-based equipment includes Crossing traffic warning rear, Lane Change Warning and Rear collision warning.

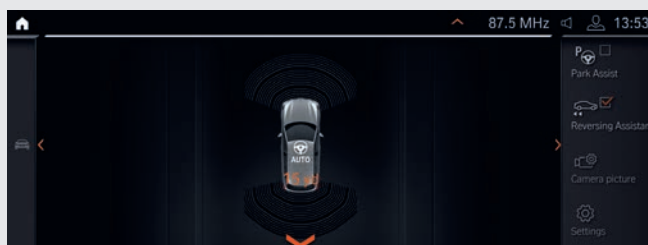

□ The Reversing Assistant* stores the last 50 m of the driven path in forward travel up to 35 km/h, so that it can be retracted if required. You are relieved of the steering work and can concentrate on monitoring the vehicle environment.

*The availability of some equipment features and functions depends on engine variants or additional options. The market and production availability may vary. You can find detailed information about terms, standard and optional equipment at www.bmw.com or at your BMW Partner.

Some ConnectedDrive Services may differ between countries. Please consult your local BMW partner for more information.

EXTERIOR COLOURS.

Discover even more with the new BMW Products app. Available now, for your smartphone and tablet.



Non-metallic 300 Alpine White¹



Non-metallic 668 Black²



Metallic A96 Mineral White²



Metallic C4W Skyscraper Grey³



Metallic 475 Black Sapphire³



Metallic C1G Snapper Rocks Blue^{2*}



Metallic C1M Phytonic Blue²



Metallic A75 Melbourne Red³



Metallic C1X Sunset Orange³

[Colour samples] These colour samples are intended as an initial guide to the colours and materials available for your BMW. However, experience has shown that printed versions of paint, upholstery and interior trim colours cannot in all cases faithfully reproduce the appearance of the original colour. Please discuss your preferred colour choices with your BMW partner or in your dealership. There you can also see original samples and be assisted with special requests.

■ Standard equipment □ Optional equipment

M SPORT PACKAGE



□ Metallic C1D M Misano Blue⁴

BMW INDIVIDUAL

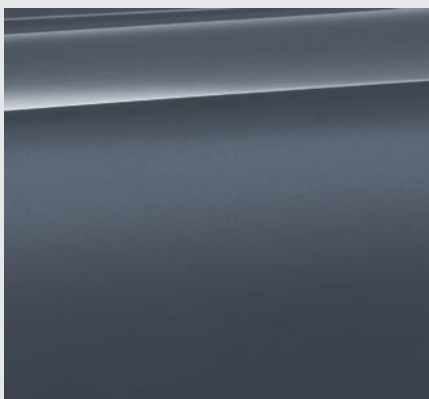

□ BMW Individual C3N Storm Bay metallic³

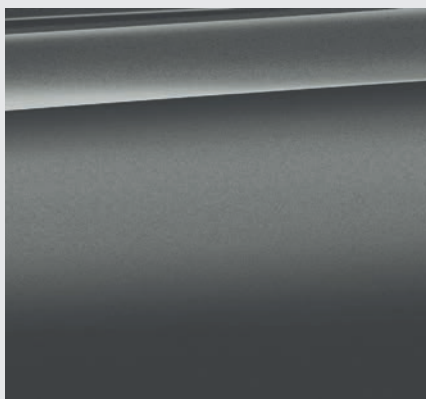

□ BMW Individual C5A Frozen Pure Grey metallic*

[BMW Individual paintwork]

Further BMW Individual customer colour requests are available on enquiry. Please discuss your preferred colour choices with your BMW partner or in your dealership.

*The availability of some equipment features and functions depends on engine variants or additional options. The market and production availability may vary. You can find detailed information about terms, standard and optional equipment at www.bmw.com or at your BMW Partner.

¹ Available as standard with the M Sport package and M135i xDrive.

² Not available with the M Sport package and M135i xDrive.

³ Optionally also available with the M Sport package and M135i xDrive.

⁴ Exclusively available with the M Sport package and M135i xDrive.

INTERIOR COLOURS.

Discover even more with the new BMW Products app. Available now, for your smartphone and tablet.

CLOTH

Available with

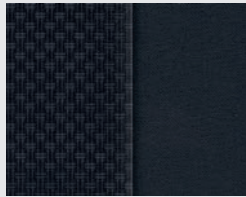

■ **Base**

Cloth 'Grid' EGAT Anthracite*

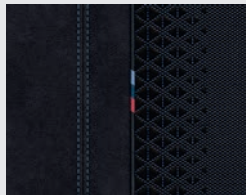

■ **M Sport package**

Cloth 'Trigon' HLSW Alcantara Black, Blue highlight*

LEATHER

Available with



Base
 Sport Line
 M Sport package

Leather 'Dakota' PDSW with perforations Black

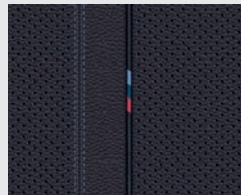

M Sport package

Leather 'Dakota' PDN4 with perforations Black, Blue highlight

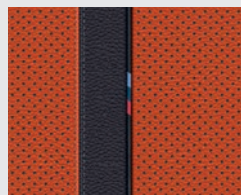

Base
 Sport Line
 M Sport package

Leather 'Dakota' PDFM with perforations Magma Red, Grey highlight*

CLOTH-SENSATEC COMBINATION

Available with

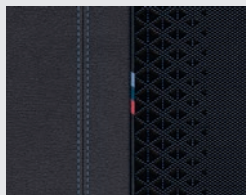

■ **M Sport package**

Cloth 'Trigon' KKSX Sensatec Black*

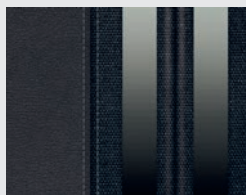

Base
 Sport Line

Cloth/Sensatec combination KFL1 Anthracite, accent Grey*

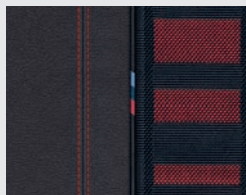

Cloth/Sensatec combination KFL3 Black, accent Red¹*

¹ Exclusively available for 128ti. Please note that even normal long- or short-term use can lead to unrecoverable

upholstery damage. This can be caused in particular by non-colourfast clothing. Please note that the interior colour depends on the selected upholstery colour.

■ Standard equipment □ Optional equipment

INTERIOR TRIM FINISHERS

Available with



■ Base

Interior trim finishers
Quartz Silver matt,
grained.*

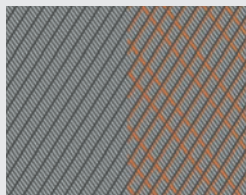

■ Sport Line
■ M Sport package

Interior trim finishers
'Illuminated Boston'
with 'Mesh' accent
on the instrument
panel and door
panel.

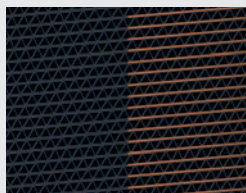

□ Base
■ Sport Line
■ M Sport package

Interior trim finishers
'Illuminated Berlin'
with 'High Matt'
accent on the
instrument panel
and door panel.

M HEADLINER

Available with

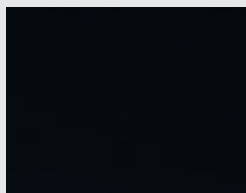

□ Base
□ Sport Line
■ M Sport package

M anthracite
headliner: Headliner
and body pillar trim
panels feature
Anthracite cloth.

*The availability of some equipment features and functions depends on engine variants or additional options. The market and production availability may vary. You can find detailed

information about terms, standard and optional equipment at www.bmw.com or at your BMW Partner.

WHEELS AND TYRES.

Discover even more with the new BMW Products app. Available now, for your smartphone and tablet.



□ 16" light alloy wheels
Star-spoke style 517, 7J x 16
with 205/55 R16 tyres.



□ 17" light alloy wheels
Multi-spoke style 546 Reflex
Silver metallic, gloss-lathed,
wheel size 7.5J x 17 with
225/45 R17 tyres.*



□ 17" light alloy wheels
Double-spoke style 548 Bicolour
Orbit Grey metallic, gloss-lathed,
7.5J x 17 with 225/45 R17 tyres.



□ 17" light alloy wheels
Double-spoke style 549 Orbit
Grey metallic, gloss-lathed,
7.5J x 17 with 225/45 R17
tyres.²



□ 17" M light alloy wheels
Double-spoke style 550 M
Bicolour Ferric Grey metallic,
gloss-lathed, wheel size
7.5J x 17 with 225/45 R17
tyres.³



□ 18" light alloy wheels
Multi-spoke style 488 Bicolour
Orbit Grey metallic, gloss-lathed,
wheel size 8J x 18 with 225/40
R18 tyres.*



□ 18" M light alloy wheels
V-spoke style 554 M Orbit
Grey metallic, 8J x 18 with
225/40 R18 tyres.⁵



■ 18" M light alloy wheels
Double-spoke style 556 M
Bicolour Cerium Grey matt,
gloss-lathed, wheel size
8J x 18 with 225/40 R18 tyres.⁴



□ 18" M light alloy wheels
Double-spoke style 819 M
Bicolour Orbit Grey metallic,
gloss-lathed, wheel size
8J x 18 with 225/40 R18 tyres.³



□ 18" M light alloy wheels
Y-spoke style 553 M Bicolour
Orbit Grey metallic with
performance tyres, gloss-lathed,
wheel size 8J x 18 with
225/40 R18 tyres.⁶,*



□ 19" M light alloy wheels
Double-spoke style 552 M
Bicolour Jet Black, gloss-lathed,
wheel size 8J x 19 with
235/35 R19 tyres.⁵,*



□ 19" M light alloy wheels
V-spoke style 557 M Bicolour
Cerium Grey metallic, wheel
size 8J x 19 with 235/35 R19
tyres.⁴

¹ Only available in conjunction with Sport Line.

² Only available in conjunction with M Sport package.

³ Exclusively available for M135i xDrive.

⁴ Only available in conjunction with M Sport package and M135i xDrive.

⁵ Exclusively available for 128ti.

*The availability of some equipment features and functions depends on engine variants or additional options. The market and production availability may vary. You can find detailed information about terms, standard and optional equipment at www.bmw.com or at your BMW Partner.

BMW M PERFORMANCE PARTS.

Equipment 24 | 25

■ Standard equipment □ Optional equipment ○ Accessories



○ Moving design. The M Performance roof spoiler is made of PUR in Black high-gloss, an elegantly athletic accent for the rear of the vehicle. At the same time, it contributes to optimised aerodynamics. The spoiler is perfectly tailored to the vehicle design and can be painted in the body colour.



○ The striking exterior mirror cap in a new, unique carbon-fibre look underlines the vehicle's high-tech character, adding an individual athletic touch.

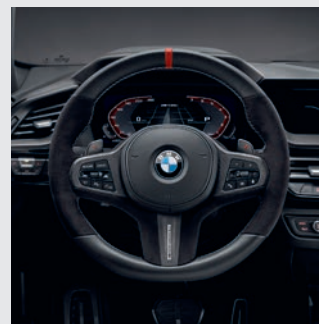

○ Gripping facts: The steering wheel with Alcantara-lined grip area provides excellent feel and grip for a sportier steering feel.



○ For a shiny, athletic look: The M Performance front splitter in black high-gloss provides optimum aerodynamics and highlights the vehicle's masculine appearance in a highly exclusive manner. A unique motorsport look for anybody who refuses to compromise.



○ The rear diffuser with new carbon-fibre look creates an even more modern appearance – and makes the vehicle's sporty look even more impressive.



○ Weight-optimised 19" M Performance light alloy wheels Double-spoke style 555 M in Bicolor Jet Black matt, gloss-lathed. TPMS summer complete wheel set.

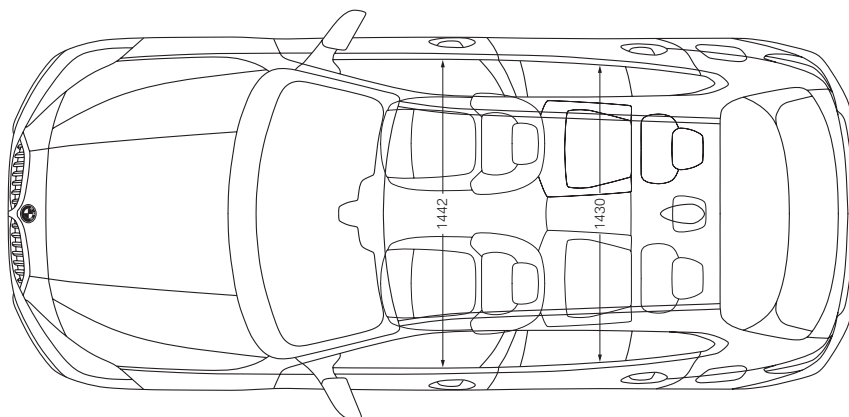
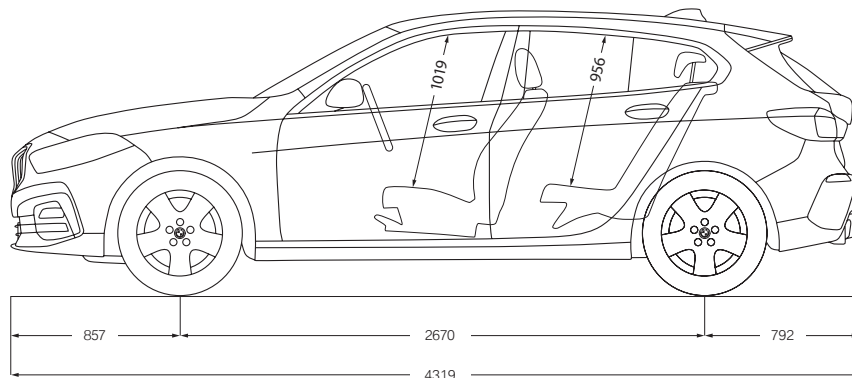
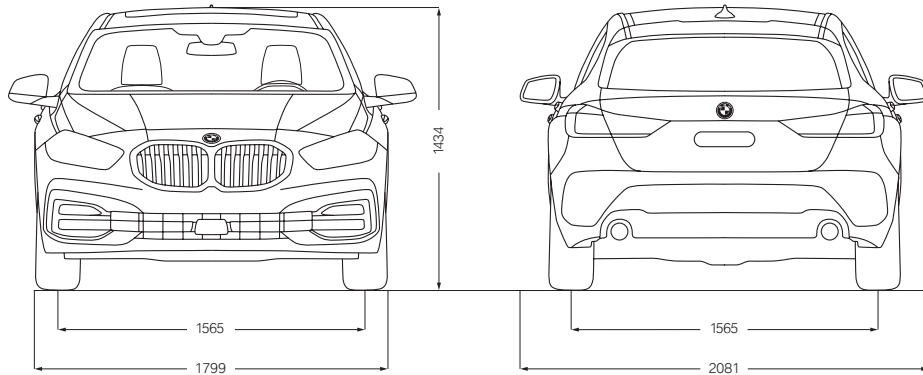

Las dimensiones del dibujo técnico están en milímetros y pueden variar en función del modelo y el equipamiento. The figures for performance, fuel consumption and CO₂ emissions refer to vehicles with standard transmission. Figures in [] are for vehicles with Steptronic transmission.

¹ The EC unladen weight refers to a vehicle with standard equipment and does not include any optional extras. The unladen weight includes a 90% full tank and a driver weight of 75 kg. Optional equipment may affect the weight of the vehicle, the payload and the top speed if the selected equipment has an impact on the vehicle's aerodynamics.

² The actual total weight of the trailer must not exceed the maximum permitted trailer load, taking into account the maximum tow bar download.

³ Performance data of petrol engines apply to vehicles using RON 98 fuel. Fuel consumption data apply to vehicles using reference fuels in accordance with EU Regulation 2007/715. Unleaded RON 91 and higher with a maximum ethanol content of 10% (E10) may also be used. BMW recommends RON 95 super unleaded petrol.

⁴ The official data for fuel consumption and CO₂ emissions was determined in accordance with the measuring procedures as defined by European Regulation (EU) 715/2007 in the applicable version. The ranges take into account differences in the selected wheel and tyre size. Figures have been determined on the basis of the new WLTP test cycle and have been converted back into NEDC figures for comparability. Values other than those specified here may apply for the assessment of taxes and other vehicle-related charges that are (also) based on CO₂ emissions.

⁵ Electronically limited.

⁶ Depending on the environmental conditions, a temporary peak performance is provided, which can be approx. 10% higher than the rated output. Peak performance duration increases with decreasing ambient temperature (at +25°C approx. 5 s, at -20°C approx. 40 s).

YOUR WORLD. MY BMW.



This feature is only available in conjunction with ConnectedDrive Services and a compatible smartphone. The availability and functions of the My BMW App depend on the vehicle model and may vary depending on the market.



The direct connection to your vehicle and the world of BMW: Conveniently check the vehicle status with the new My BMW App, access functions remotely, make a service appointment, plan trips and much more – this way, the app becomes your daily mobility companion.

Try it out for yourself and install the My BMW App from your Google play or App Store.

