



T H E



2
GRAN
COUPÉ



YOUR WORLD. My BMW.

Try it out for yourself and install the My BMW App from your Google play or App Store.





20 Highlights

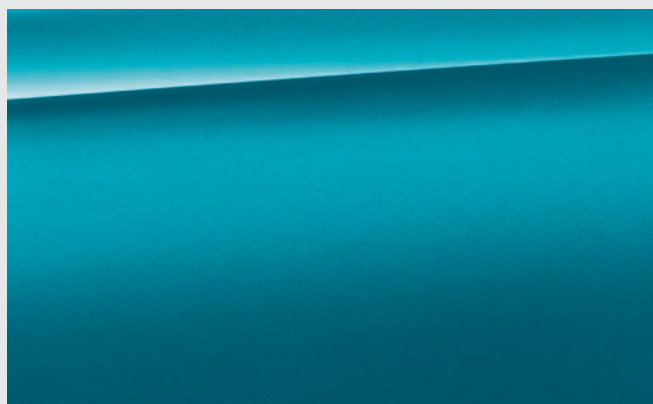

22 Worlds of colour



24 Wheels and tyres / Original BMW Accessories

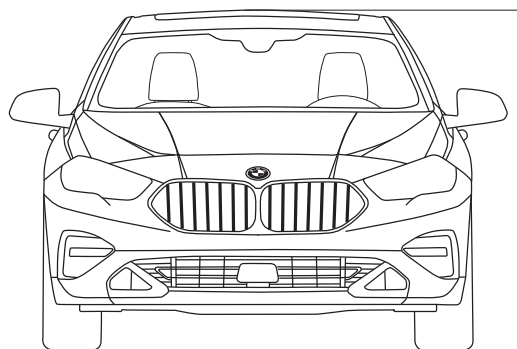

26 Technical data



**DOUBT? LONG
SINCE OVERTAKEN.**





A REAR LIKE
E THAT REQ
UIRES CONF
IDENCE.



**DRIVING WITH
STYLE INSTEAD
OF DRIVING
STYLE.**





FIRE
HOSE
KEEP CLEAR

DRY

The image shows the interior of a car, focusing on the front seats which are upholstered in black leather with visible stitching. The view through the passenger window shows a bright yellow corrugated metal building. A blue sign on a pole is visible outside, with the text "PARKING ONLY" and "NO 2ND" below it. The car's interior is dark, and the overall lighting is bright, suggesting a sunny day.

YOUR PARENTS CAN DRIVE SOMETHING ELSE.



**NOTHING
IS THE WAY Y
OU KNOW IT.**









A teal car is parked on a paved surface next to a dark green metal fence. Two yellow bollards are visible in the foreground. The background shows a building with a red horizontal band and a perforated metal facade. The scene is brightly lit, suggesting a sunny day.

THERE'S NO SECOND CHANCE FOR A BLATANT IMPRESSION.



**GROW UP?
LEAVE THEM
AT TO OTHERS.**





**VARIETY IN ALL ITS FACETS –
THE BMW 2 SERIES GRAN COUPÉ.**

HIGHLIGHTS.

Discover even more with the new BMW Products app. Available now, for your smartphone and tablet.



□ The Adaptive LED headlights contain low-beam and high-beam light including the dazzle-free high-beam assistant BMW Selective Beam as well as direction indicators in full LED technology. The equipment also features cornering lights, daytime running lights and Adaptive headlights with city, country and motorway mode for excellent illumination of the road ahead.



□ When open, the Panorama glass roof provides a great deal of fresh air. Closed, it creates a bright, light-flooded atmosphere in the interior. It opens and closes completely automatically at the push of a button or with the vehicle key and is equipped with slide and lift functions, a roller sunblind and wind deflector.



□ The 8-speed Steptronic Sport transmission^{1,*} offers incredibly sporty gear changes. Whether automatic or manual using gearshift paddles or gear lever.



□ The BMW Live Cockpit Professional with navigation function includes two high-quality displays consisting of a high-resolution 10.25" Control Display that can be operated by touch and a fully digital 10.25" instrument display. The BMW Operating System 7 can also be operated via the iDrive Touch Controller.

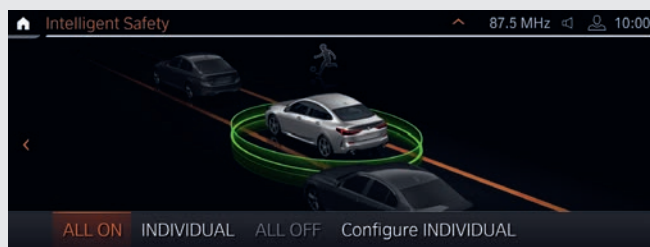

□ The safety package Driving Assistant^{2,*} includes the camera-based systems front collision warning with braking function, Speed Limit Assist incl. Speed Limit Info with No-overtaking indicator with preview and Lane Departure Warning. Additionally, the radar-based equipment includes Crossing traffic warning rear, Lane Change Warning and Rear collision warning.

¹ Standard for M235i xDrive.

² Function may be limited in darkness, fog or bright glare.

³ Only available in conjunction with M Sport package and M235i xDrive.

⁴ The driver is responsible for constantly monitoring the automated parking procedure in accordance with local road laws.

■ Standard equipment □ Optional equipment



□ The M sports seats^{3,*} with integrated headrests, deep sitting surface and high side and backrest bolsters offer the driver and front passenger^{3,*} improved support, even in fast turns. In addition, the seat can be adjusted to your individual body size thanks to the integrated backrest width adjustment.



□ The outstanding Harman Kardon surround sound system* features a 464W digital amplifier, nine channels and 16 speakers. Its extremely harmonious sound perfectly fills the interior space. Fully automatic, speed-dependent equalising precisely compensates for any background driving noise.



■ The Through-loading system with rear seat backrests, which are divisible in a 40:20:40 ratio, guarantees flexibility when transporting people and objects.



□ Interior and driver-side exterior mirrors with automatic anti-dazzle function, including electric fold-in function for the exterior mirrors and automatic curb parking function for the front passenger exterior mirror.

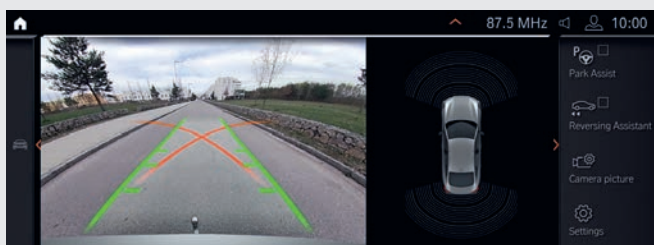

□ Parking Assistant⁴ makes parking the vehicle easier. The Rear View camera provides a clearer view behind the vehicle. Active Park Distance Control offers increased protection against damage caused by parking. Parking Assistant parks the vehicle automatically, parallel or perpendicular to the street, and leaves parallel parking spaces.⁴ The Reversing Assistant supports you when reversing, e.g. in narrow lanes.

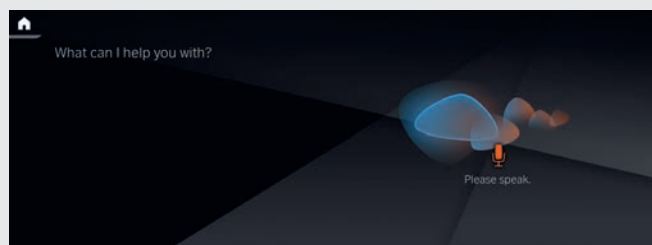

□ Wouldn't it be incredible if your BMW was also your personal vehicle expert? Communicate with your vehicle using the BMW Intelligent Personal Assistant*. Say natural commands to operate numerous vehicle functions. It can also explain topics about your vehicle and helps you to get to know your BMW even better.

* The availability of some equipment features and functions depends on engine variants or additional options. The market and production availability may vary. You can find detailed information about terms, standard and optional equipment at www.bmw.com or at your BMW Partner. Some ConnectedDrive Services may differ between countries. Please consult your local BMW partner for more information.

EXTERIOR COLOURS.



Non-metallic 300 Alpine White¹

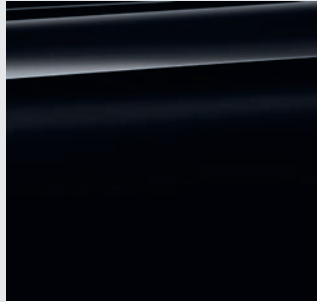

Non-metallic 668 Black



Metallic A96 Mineral White*

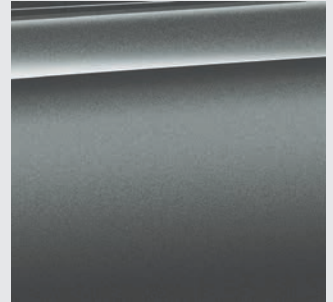

Metallic C4W Skyscraper Grey



Metallic 475 Black Sapphire²



Metallic A75 Melbourne Red²



Metallic C1X Sunset Orange*



Metallic C1M Phytionic Blue*

M SPORT PACKAGE



Metallic C1D M Misano Blue metallic³



Metallic C1G Snapper Rocks Blue³

BMW INDIVIDUAL

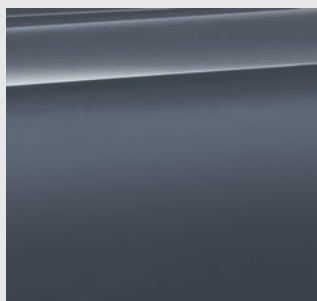

BMW Individual C3N Storm Bay metallic²

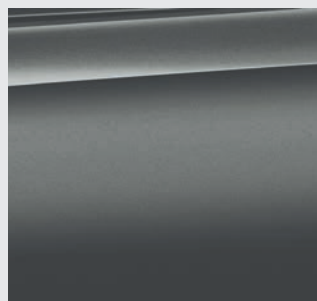

BMW Individual C5A Frozen Pure Grey metallic*

[Colour samples] These colour samples are intended as an initial guide to the colours and materials available for your BMW. However, experience has shown that printed versions of paint, upholstery and interior trim colours cannot in all cases faithfully reproduce the appearance of the original colour. Please discuss your preferred colour choices with your BMW partner or in your dealership. There you can also see original samples and be assisted with special requests.

[BMW Individual paintwork] Further BMW Individual customer colour requests are available on enquiry. Please discuss your preferred colour choices with your BMW partner or in your dealership.

INTERIOR COLOURS.

Equipment 22 | 23

■ Standard equipment □ Optional equipment

CLOTH

Available with

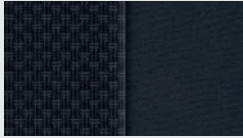

■ **Base model**

Cloth 'Grid' EGAT Anthracite



□ **M Sport package**

Cloth 'Trigon' HLSW Alcantara Black with blue highlights*

SENSATEC

Available with

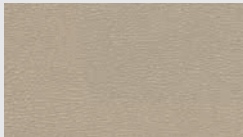

□ **Base model**
□ **Sport Line**
□ **M Sport package**

Sensatec KCCX Oyster*

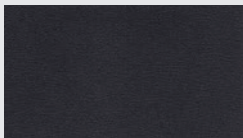

□ **Base model**
□ **Sport Line**
□ **M Sport package**

Sensatec KCSW Black*

CLOTH-SENSATEC COMBINATION

Available with

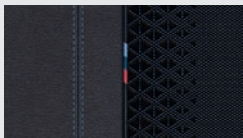

■ **M Sport package**

Cloth 'Trigon' KKSW Sensatec Black⁴

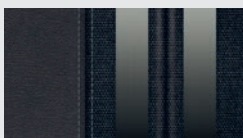

□ **Base model**
■ **Sport Line**

Cloth/Sensatec combination KFL1 Anthracite, accent Grey*

LEATHER

Available with

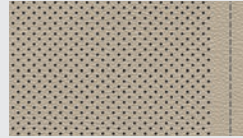

□ **Base model**
□ **Sport Line**
□ **M Sport package**

Leather 'Dakota' PDOA with perforations Oyster and Grey highlight*



□ **Base model**
□ **Sport Line**
□ **M Sport package**

Leather 'Dakota' PDSW with perforations Black*

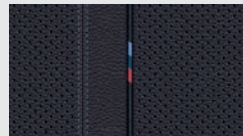

□ **M Sport package**

Leather 'Dakota' PDN4 with perforations Black, Blue highlight*

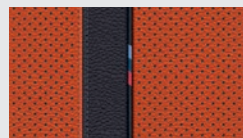

□ **Base model**
□ **Sport Line**
□ **M Sport package**

Leather 'Dakota' PDFM with perforations Magma Red, Grey highlight*

INTERIOR TRIM FINISHERS

Available with

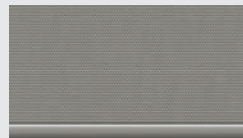

■ **Base model**

Interior trim finishers Quartz Silver matt, grained.

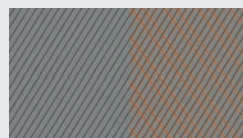

■ **Sport Line**
■ **M Sport package**

Interior trim finishers 'Illuminated Boston' with 'Mesh' accent on the instrument panel and door panel.



□ **Base model**
■ **Sport Line**
■ **M Sport package**

Interior trim finishers 'Illuminated Berlin' with 'High Matt' accent on the instrument panel and door panel.

M HEADLINER

Available with

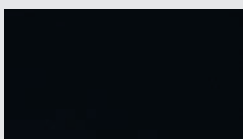

□ **Base model**
□ **Sport Line**
■ **M Sport package**

M headliner 775 Anthracite⁴

¹ Available as standard with the M Sport package and M235i xDrive.

² Optionally also available with the M Sport package and M235i xDrive.

³ Exclusively available with the M Sport package and M235i xDrive.

⁴ Standard for M235i xDrive.

WHEELS AND TYRES.



■ 16" light alloy wheels Star-spoke style 517 Ferric Grey, 7J x 16, 205/55 R16 tyres.*



■ 17" light alloy wheels Multi-spoke style 546 Reflex Silver metallic, gloss-lathed, wheel size 7.5J x 17 with 225/45 R17 tyres.*



□ 17" light alloy wheels Double-spoke style 548 Bicolour Orbit Grey metallic, gloss-lathed, 7.5J x 17 with 225/45 R17 tyres.*



■ 17" light alloy wheels Double-spoke style 549 Orbit Grey metallic, gloss-lathed, 7.5J x 17 with 225/45 R17 tyres.²



□ 18" light alloy wheels Multi-spoke style 488 Bicolour Orbit Grey metallic, gloss-lathed, wheel size 8J x 18 with 225/40 R18 tyres.



□ 18" M light alloy wheels Y-spoke style 553 M Bicolour Orbit Grey metallic, gloss-lathed, wheel size 8J x 18 with 225/40 R18 tyres.



□ 18" M light alloy wheels V-spoke style 554 M Orbit Grey metallic, 8J x 18 with 225/40 R18 tyres.³*



■ 18" M light alloy wheels Double-spoke style 556 M Bicolour Cerium Grey matt, gloss-lathed, wheel size 8J x 18 with 225/40 R18 tyres.⁴



■ 18" M light alloy wheels Double-spoke style 819 M Bicolour Orbit Grey metallic, gloss-lathed, wheel size 8J x 18 with 225/40 R18 tyres.⁵



□ 19" M light alloy wheels V-spoke style 557 M Bicolour Cerium Grey metallic, wheel size 8J x 19 with 235/35 R19 tyres.⁴*



□ 19" M light alloy wheels Double-spoke style 552 M Bicolour Jet Black, gloss-lathed, wheel size 8J x 19 with 235/35 R19 tyres.³*

¹ Only available in conjunction with Sport Line.

² Exclusively available in conjunction with M Sport package and M235i xDrive.

³ Exclusively available for M235i xDrive.

⁴ Exclusively available in conjunction with M Sport package.

*The availability of some equipment features and functions depends on engine variants or additional options. The market and production availability may vary. You can find detailed information about terms, standard and optional equipment at www.bmw.com or at your BMW Partner.

ORIGINAL BMW ACCESSORIES.

Equipment 24 | 25

■ Standard equipment □ Optional equipment ○ Accessories



○ The LED door projectors are activated when the doors are opened. They project an image onto the ground next to the car using an interchangeable slide.



○ The perfectly fitted, anti-slip, durable mat with raised borders on all sides protects the luggage compartment from dirt and moisture. It is designed in Black.



○ Wireless charging, any time and anywhere: Thanks to the BMW wireless charging station universal the smartphone can be charged comfortably and efficiently without a cable in the vehicle. The mobile phone is saved in a stable and safe way. Especially smart: The integrated powerbank can be removed and enables wireless charging outside the vehicle.



○ The perfectly fitted, durable all-weather floor mats with a raised border and elegant design protect the front footwell against moisture and dirt. They are black and feature a stainless steel inlay.



○ Sporty 18" M Performance forged wheels, V-spoke style 554 M in Jet Black matt. TPMS summer complete wheel set, wheel size 8J x 18.

TECHNICAL DATA.

BMW 2 Series Gran Coupé	218i	220i 220i xDrive	M235i xDrive	218d	220d 220d xDrive
-------------------------	------	---------------------	-----------------	------	---------------------

Weight						
Unladen EU (xDrive) ¹	kg	1425 [1450]	[1505] ([1595])	[(1645)]	1500 [1545]	[1580] ([1640])
Max. permissible weight (xDrive)	kg	1885 [1905]	[1965] ([2060])	[(2105)]	1985 [2015]	[2050] ([2110])
Permitted load (xDrive)	kg	535 [530]	[535] ([540])	[(535)]	560 [545]	[545] ([545])
Permitted trailer load, unbraked (xDrive) ²	kg	710 [725]	[750] ([750])	–	750 [750]	[750] ([750])
Permitted trailer load, braked, max. 12% gradient/max. 8% gradient (xDrive) ²	kg	1300/1300 [1300/1300]	[1300/1300] ([1300/1300])	–	1300/1300 [1300/1300]	[1300/1300] ([1500/1500])
Luggage capacity	l	430	430	430	430	430

BMW TwinPower Turbo engine ³						
Cylinders/valves		3/4	4/4	4/4	4/4	4/4
Capacity	cm ³	1499	1998	1998	1995	1995
Max. output/engine speed	kW (hp)/ rpm	100 (136)/ 4500–6500	131 (178)/ 5000–5500	225 (306)/ 5000–6250	110 (150)/4000	140 (190)/4000
Max. torque/engine speed	Nm/ rpm	220/ 1500–4100	280/ 1350–4200	450/ 1800–4500	350/ 1750–2500	400/ 1750–2500

Power transmission						
Type of drive (xDrive)		Front-wheel	Front-wheel (All-wheel)	(All-wheel)	Front-wheel	Front-wheel (All-wheel)
Standard transmission (xDrive)		6-speed manual	7-speed Steptronic with double clutch (8-speed Steptronic transmission)	(8-speed Steptronic Sport transmission)	6-speed manual	8-speed Steptronic transmission (8-speed Steptronic transmission)

Driving performance						
Top speed (xDrive)	km/h	215 [215]	[238] ([234])	[(250)] ⁵	222 [222]	[235] ([234])
Acceleration 0–100 km/h (xDrive)	s	9.2 [9.1]	[7.1] ([7.1])	[(4.9–4.8 ⁶)]	8.6 [8.5]	[7.5] ([7.3])

Consumption ^{3,4} – All engines conform to the EU6 standard						
Combined (xDrive)	l/100km	6.6–5.6 [6.5–5.6]	[6.7–5.9] ([7.4–6.5])	[(7.8–7.2)]	5.2–4.5 [5.5–4.8]	[5.6–4.9] ([5.7–5.1])
Exhaust emissions standard (type-certified)		EU6d	EU6d	EU6d	EU6d	EU6d
Combined CO ₂ emissions (xDrive)	g/km	149–128 [149–128]	[154–136] ([166–149])	[(175–162)]	136–118 [143–125]	[145–129] ([150–134])
Tank capacity, approx.	l	42	50	50	42	50

Wheels/tyres						
Tyre dimensions		205/55 R16 W	225/45 R17 Y	225/40 R18 Y	205/55 R16 W	225/45 R17 Y
Wheel size		7Jx16	7.5Jx17	8Jx18	7Jx16	7.5Jx17
Material		Light alloy	Light alloy	Light alloy	Light alloy	Light alloy

The dimensions in the technical drawing are in millimetres and may vary depending on the model and optional equipment.

The figures for driving performance, fuel consumption and CO₂ emissions refer to vehicles with standard transmission. Figures in [] are for vehicles with Steptronic transmission.

¹ The EC unladen weight refers to a vehicle with standard equipment and does not include any optional extras. The unladen weight includes a 90% full tank and a driver weight of 75 kg. Optional equipment may affect the weight of the vehicle, the payload and the top speed if the selected equipment has an impact on the vehicle's aerodynamics.

² The actual total weight of the trailer must not exceed the maximum trailer load, taking into account the maximum tow bar download.

³ Performance data of petrol engines apply to vehicles using RON 98 fuel. Fuel consumption data apply to vehicles using reference fuels in accordance with EU Regulation 2007/715. Unleaded RON 91 and higher with a maximum ethanol content of 10% (E10) may also be used. Depending on the model, BMW recommends RON 95 super unleaded petrol or RON 98 super plus unleaded petrol. Your local BMW Partner is available to provide further details.

⁴ Official data for fuel consumption and CO₂ emissions was determined in accordance with the prescribed measuring procedure and corresponds to European Regulation (EC) 715/2007 in the applicable version. For ranges, data determined as per WLTP takes into account any optional equipment (available on the German market in this case). For vehicles that have been newly type approved since 1 January 2021, only the official data according to WLTP exists. For more information about NEDC and WLTP measuring procedures visit www.bmw.com/wltp

⁵ Electronically limited.

⁶ Only available in conjunction with the optional M Performance package.

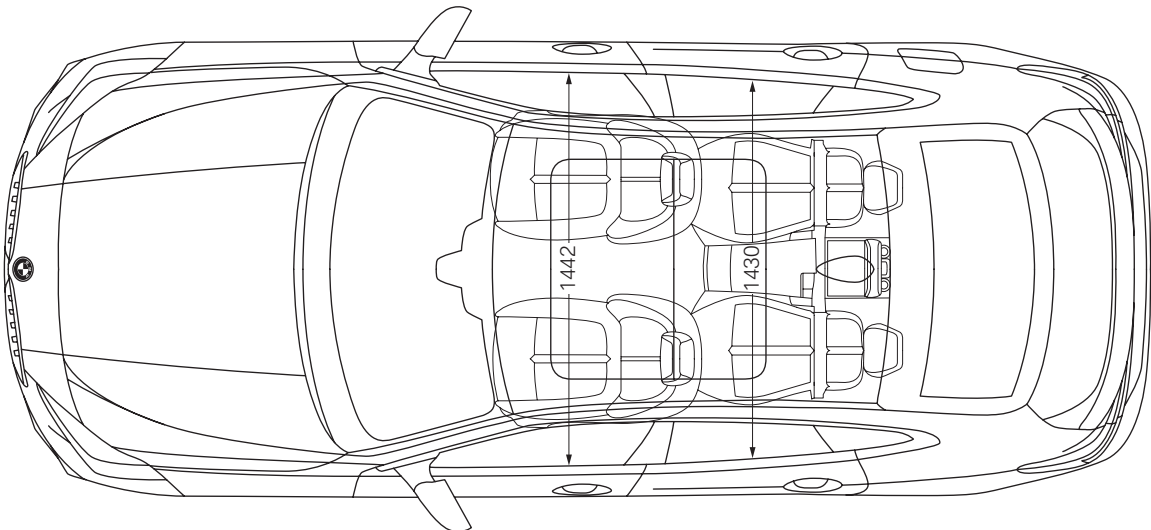
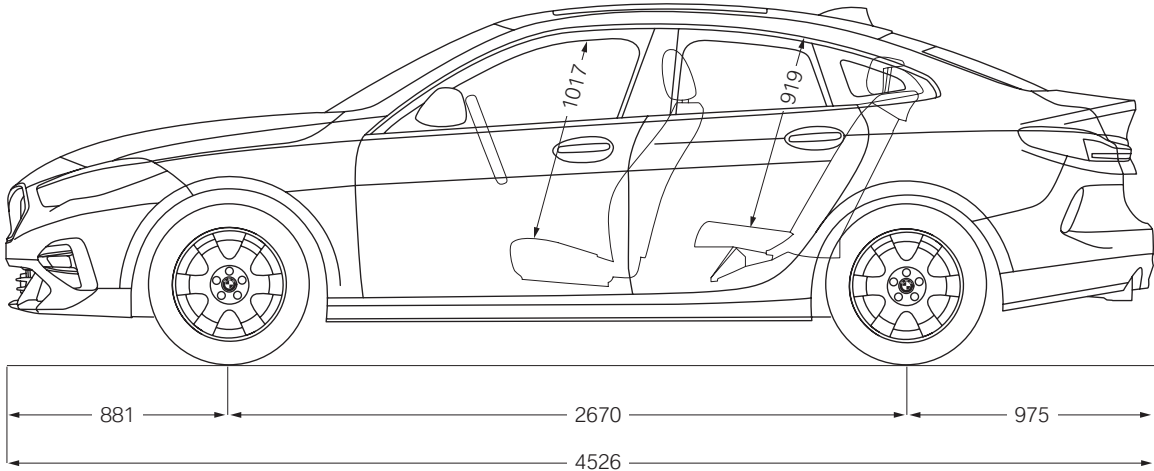
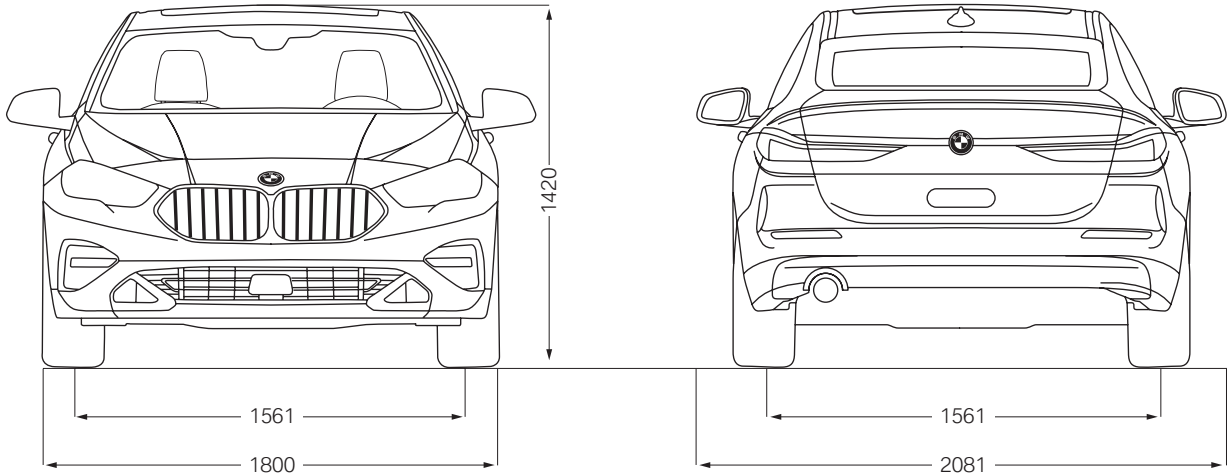

YOUR WORLD. MY BMW.



This feature is only available in conjunction with ConnectedDrive Services and a compatible smartphone. The availability and functions of the My BMW App depend on the vehicle model and may vary depending on the market.



The direct connection to your vehicle and the world of BMW: Conveniently check the vehicle status with the new My BMW App, access functions remotely, make a service appointment, plan trips and much more – this way, the app becomes your daily mobility companion.

Try it out for yourself and install the My BMW App from your Google play or App Store.

