

T H E

X B







Highlights

- Exterior and interior design
- Connectivity
- Assistance systems
- Driving dynamics
- X3 xDrive30i
- X3 M40i and M40d
- X3 M Competition

Model Overview

Vehicle types

- Base
- M Sport package
- M40i and M40d
- X3 M
- X3 M Competition
- X3 xDrive30e

Equipment

Exterior Colours

Interior Colours

Wheels and Tyres

**Original BMW Accessories
and BMW M Performance
Parts**

Technical values

BMW Services

BMW X3 xDrive30e:

Z1* BMW Individual V-spoke 726 l light alloy wheels with mixed tyres and run-flat tyres, exterior colour in Sophisto Grey brilliant effect, Sensatec perforated sport seats | Cognac, fine-wood trim Ash Trunk open-pored with highlight trim finisher Pearl Chrome.

Alterations in standard and optional equipment and the configurations available for the different models, as described in this brochure, may occur. Your local BMW Partner is available to provide further details. Subject to change in design and equipment.



INDEPENDENCE BEGINS WHEN
OLD HABITS ARE LEFT BEHIND.

THE BMW X3.



ALWAYS AHEAD OF THE TREND.

Thanks to sporty, streamlined surfaces and iconic highlights on the exterior as well as a unique combination of athleticism and comfort in the interior, the BMW X3 shows you where

you're heading – and will be the first to confidently get to the destination.

A CLEAR MESSAGE: THE FRONT.

Already from the front, the dynamic presence and typically focused expression of the BMW X3 are thrillingly obvious. Tight, ample surfaces in vehicle colour powerfully extend around the central icon – BMW's characteristic radiator grille. At the same time, traditional X elements create an incomparable feeling of liberty that is intensified further by sporty details. Simply put, a character that immediately expresses the urge for daily adventures – the BMW X3.



□ Particularly **slim headlights** intensify the striking look of the BMW X3 onto the road ahead. Equipped with full LED technology or BMW Laserlight they guarantee optimum illumination of the road.

■ Appealing icon: the **large BMW double radiator grille** is encased by a single-part frame. Its striking, angular design towards the top clearly indicates the appealing self-confidence that characterises the BMW X3.

■ Standard equipment □ Optional equipment

The availability of some equipment, functions, and digital services depends on engine variants or additional optional equipment. The offer structure as well as market and production availability may vary.

For detailed information on availability, terms and costs, please contact your local BMW partner.





SPORTINESS MEETS SOLIDITY: THE SIDE VIEW.

A perfect balance of all qualities that characterise the BMW X3 from the side and make it seem so fascinating. Tight, ample surfaces particularly emphasise the typical proportions of a BMW X. Its dynamic outline already triggers anticipation for the next invigorating driving experience at first glance.



■ **The rear lights with full LED technology** make the rear view of the BMW X3 seem even sharper. The distinctive, three-dimensional modelling of red areas with integrated turn indicators additionally underlines the presence of the rear end.





The BMW X3 has a wide, confident stance. This impression is further enhanced by pronounced, horizontal lines. The underide protection also emphasises the modern, reduced design language from this perspective: it frames free-form tailpipe trims as part of a three-dimensional impression and lends the BMW X3 a clear conclusion towards the road.

POWERFUL STATEMENT: THE REAR.



■ Standard equipment □ Optional equipment

The availability of some equipment, functions, and digital services depends on engine variants or additional optional equipment. The offer structure as well as market and production availability may vary.

For detailed information on availability, terms and costs, please contact your local BMW partner.

A noticeable sporting character combined with a clear orientation towards the driver and cutting-edge elegance – take a seat in the BMW X3 and immediately enjoy that pleasant feeling of being in full control and having a complete overview. Ample decor and clearly structured control and information elements will set your heart racing as soon as you have taken your comfortable seat in the focus of the action.

■ Always the best seats: the **sport seats** in the BMW X3 feature the most recent Sensatec generation upholstery. Its refined structure generates an extremely pleasant haptic perception while the material's perforation guarantees ideal seat ventilation – even when the thrilling driving experience sends your heart racing.

ATHLETIC AESTHETICS: THE INTERIEUR.



□ The Controller with integrated **air conditioning control panel** harmoniously integrates into the centre console featuring a **12.3" information display** to guarantee a perfect overview – the standard display size is 10.25". High-grade, galvanised elements, for instance around the fresh air vents, represent elegant highlights and emphasise the sporty, horizontal lines of the interior equipment.



FREEDOM BEGINS WITH CONNECTION.

Leave everything behind – but stay connected to what is important to you: comprehensive connectivity and infotainment functions in the BMW X3 guarantee that

you can easily and seamlessly bring your digital life into the vehicle and are provided with the support you need at any time – regardless of where you are heading.

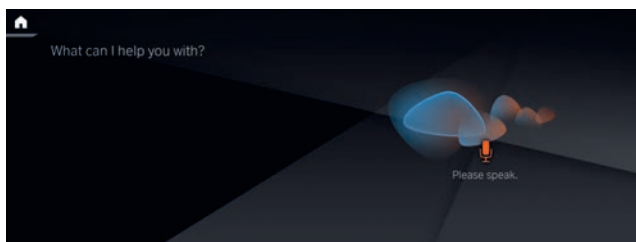

■ Standard equipment □ Optional equipment

¹ This feature is only available in conjunction with ConnectedDrive Services and a compatible smartphone. The range of functions depends on the apps installed on the smartphone.

² An Amazon account is required for the integration of Amazon Alexa Car Integration.

³ Amazon, Alexa and all associated logos are trademarks of Amazon.com, Inc. or its affiliates.

⁴ For this vehicle model, the touch functionality for the iDrive controller can currently not be offered.



□ Always intelligent by your side: The **BMW Intelligent Personal Assistant** not only has all the answers to any question about the BMW X3, it can also be operated particularly intuitively thanks to extended language functions to guarantee that you will absolutely feel good in the BMW X3 from the outset.

□ The **BMW Live Cockpit Professional** is where everything comes together. This innovative display cluster consists of a high-resolution 12.3" central information display as well as a fully digital 12.3" multifunctional instrument display that can be controlled very intuitively, for instance by voice control or using the iDrive Touch Controller⁴.

The seamless connection to your BMW X3, simply on your smartphone – the **My BMW App**¹ links you to your vehicle and acts as your personal mobility assistant. Keep an overview of your vehicle and use numerous, innovative, digital functions – convenient, intuitive and mobile, just right for the adventures of everyday life.

□ You can even enjoy **Amazon Alexa**^{2,3} just like at home in the BMW X3. The voice assistant is seamlessly integrated into your vehicle, so you can easily continue your digital life on the road.



EVERYTHING UNDER CONTROL. WITH CERTAINTY.

The BMW X3 is always at your side, providing reliable support even in challenging driving situations. An intelligent combination of sensor system, driver assistance systems

and safety technologies make sure you feel perfectly comfortable during every trip and master any situation with superiority.

□ The innovative **Driving Assistant Professional**¹ combines driving technologies in a comprehensive assistant for any trip: it combines anything that makes driving more pleasant, safer and convenient, from passive safety systems to active hazard warning systems and functions for partially automated driving.

□ A good feeling: in an emergency the **Emergency Stop Assistant** in your BMW X3 will automatically take control, bring the vehicle to a standstill in a safe position and make an emergency call.

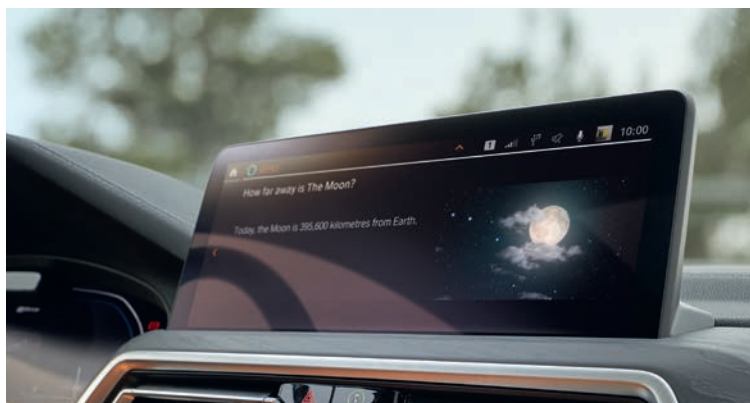

■ Standard equipment □ Optional equipment

¹ Function may be limited in darkness, fog or bright glare. The availability of some equipment, functions, and digital services depends on engine variants or additional optional equipment. The offer structure as well as market and production availability may vary.

For detailed information on availability, terms and costs, please contact your local BMW partner.



DYNAMICS UNLIMITED.

Sparks a passion every time it accelerates, over and over again: the BMW X3 impresses with absolute driving pleasure from the first metre. Accurate self-steering properties, superior power development and invigorating

agility come together to form typical BMW handling that creates the ultimate driving pleasure experience, including unique vehicle efficiency – regardless of the route you choose.

■ Standard equipment □ Optional equipment

¹ Only available for M40i and M40d.
The availability of some equipment, functions, and digital services depends on engine variants or additional optional equipment.

The offer structure as well as market and production availability may vary.
For detailed information on availability, terms and costs, please contact your local BMW partner.



■ No matter what everyday life has in store for you – **BMW xDrive** all-wheel drive combines the benefits of traction, directional stability and driving safety with classic BMW agility.

□ The sporty setup of the **adaptive M suspension**¹ always guarantees optimum traction on all road surfaces and, depending on the Driving Experience Control setting, enables a particularly sporty or comfortable chassis and suspension setup.

□ Even more agile in any driving situation: thanks to demand-based power distribution at the rear wheels, **Performance Control** tangibly boosts the driving dynamics of the BMW X3 even further, most of all when cornering.

HIGHEST ELATION.

THE BMW X3 xDRIVE30i
WITH M SPORT PACKAGE.



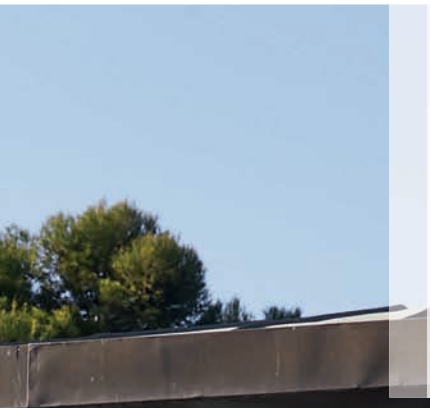

T H E

X3 M40i
X3 M40i
X3 M40i
X3 M40i





DOESN'T ASK QUESTIONS.
BUT ANSWERS THEM ALL.

Shown here in BMW Individual special paintwork M Malachite Green metallic.
The availability of some equipment, functions, and digital services depends on engine variants or additional optional equipment. The offer structure as well as market and production availability may vary. For detailed information on availability, terms and costs, please contact your local BMW partner.





T H E
X3 M
X3 M
X3 M
C O M P E T I T I O N

EVERY METRE
IS A MILESTONE.

MODEL VARIANTS AT A GLANCE.

BASE

Independence and an urge to get ahead: the unique character of the BMW X3 is apparent at first glance thanks to special X-typical equipment ranges in the interior and exterior – and it feels impressively dynamic whenever you drive it.



M SPORT PACKAGE



Re-designed front and rear bumpers, new paintwork colours, light-alloy wheels, interior trim finishers and more – the M Sport package further intensifies the athletic personality of the BMW X3.

BMW M AUTOMOBILES

M40i AND M40d



With exciting exterior trim features – the BMW M40i and M40d models of the BMW X3 confidently leave old concepts behind.

X3 M



A genuine M – and a genuine X: the BMW X3 M represents absolute motivation and the adrenaline-charged feeling of absolute high performance.

X3 M COMPETITION



Competition means merely seeing it in the interior mirror: the BMW X3 M Competition dominates the field emotionally, visually and physically from the very first moment onwards.

BMW PLUG-IN HYBRID

X3 xDRIVE30e



Two drivetrains that will take you anywhere: the BMW X3 xDrive30e combines the best of a combustion engine and electric drive – for a sustainable driving feeling brimming with dynamism and euphoria.

BASE.



■ The adjustable sport seats for the driver and front passenger feature numerous manual adjustment options, including fore-and-aft position and backrest angle. Thanks to larger seat and backrest bolsters, and well-defined side bolsters, they provide excellent ergonomics and a high degree of lateral support.

■ The black Sport leather steering wheel with three spokes features a Chrome decorative trim. A thick rim and contoured thumb rests provide an exceptionally pleasant, high-grip feel.



■ 18" light alloy wheels V-spoke style 618 in Reflex Silver, wheel size 7J x 18, with 225/60 R18 tyres.

□ 20" light alloy wheels Y-spoke style 695 Bicolour Orbit Grey with mixed tyres, gloss-lathed, front 8J x 20 with 245/45 R20 tyres, rear 9.5J x 20 with 275/40 R20 tyres.

SELECTED BASE MODEL EXTERIOR EQUIPMENT FEATURES:

- 18" V-spoke style 618 light alloy wheels
- LED headlights
- Window recess finisher strip and roof rails, matt aluminium
- Servotronic

SELECTED BASE MODEL INTERIOR EQUIPMENT FEATURES:

- Sport seats for driver and front passenger
- Sensatec perforated
- Black high-gloss trim with Pearl Chrome finisher
- Sport leather steering wheel
- Steptronic transmission
- Automatic air conditioning
- BMW Live Cockpit Plus
- Interior and exterior mirror package
- Stereo speaker system

The availability of some equipment, functions, and digital services depends on engine variants or additional optional equipment. The offer structure as well as market and production availability may vary. For detailed information on availability, terms and costs, please contact your local BMW partner.

■ Standard equipment □ Optional equipment

M SPORT PACKAGE.



■ The adjustable sport seats for the driver and front passenger feature numerous manual adjustment options, including fore-and-aft position and backrest angle. Thanks to larger seat and backrest bolsters, and well-defined side bolsters, they provide excellent ergonomics and a high degree of lateral support.

■ The M Leather steering wheel including multifunction buttons, an M badge and an integrated driver-side airbag is featured in three-spoke design. With a steering wheel rim in leather 'Walknappa' Black with black stitching and contoured thumb rests, it provides a direct, athletic steering experience.



■ 19" M light alloy wheels Double-spoke style 887 M Bicolour Black-Grey, 7.5J x 19 with 245/50 R19 tyres.

□ 20" M light alloy wheels Double-spoke style 699 M Jet Black uni with mixed tyres, front 8J x 20 with 245/45 R20 tyres, rear 9.5J x 20 with 275/40 R20 tyres.

M SPORT PACKAGE EXTERIOR EQUIPMENT:

- M Aerodynamics package with front apron, side sills and wheel arch trims in body colour
- 19" M light alloy wheels Y-spoke style 887 M Bicolour Black-Grey; other wheels available
- M Sport suspension, optionally Adaptive suspension
- M roof rails high-gloss Shadow Line, alternatively roof rails Aluminium satinised
- M high-gloss Shadow Line, alternatively BMW Individual Exterior Line Aluminium satinised
- M designation on the sides
- Exterior mirror caps in body colour
- Optional M sports brake in Blue metallic, alternatively Red high-gloss
- Rear apron with diffuser insert in Black high-gloss
- Tailpipe trim strip in Chrome high-gloss in M Sport package specific design
- Exclusive paintwork in M Brooklyn Grey metallic, alternatively M Carbon Black metallic; other paintwork available

M SPORT PACKAGE INTERIOR EQUIPMENT:

- M entry sills, M driver's footrest and M specific pedals
- Sport seats for driver and front passenger, optional M Sport seats
- Optional exclusive 'Vernasca' Black leather with Blue contrast stitching including instrument panel in Sensotec with blue stitching
- M leather steering wheel with multifunction buttons
- Vehicle key with exclusive M designation
- M anthracite headliner
- M interior trim finishers in Aluminium Rhombicle Dark with highlight trim finishers in Pearl Chrome; other trims available
- Loading sill of the luggage compartment in stainless steel

The availability of some equipment, functions, and digital services depends on engine variants or additional optional equipment. The offer structure as well as market and production availability may vary. For detailed information on availability, terms and costs, please contact your local BMW partner.

■ Standard equipment □ Optional equipment

M40i AND M40d.

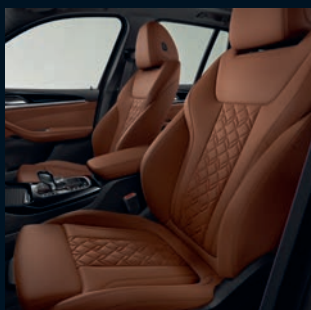

■ The adjustable sport seats for the driver and front passenger feature numerous manual adjustment options, including fore-and-aft position and backrest angle. Thanks to larger seat and backrest bolsters, and well-defined side bolsters, they provide excellent ergonomics and a high degree of lateral support.

■ The M Leather steering wheel including multifunction buttons, an M badge and an integrated driver-side airbag is featured in three-spoke design. With a steering wheel rim in leather, 'Walknappa' Black with black stitching and contoured thumb rests, it provides a direct, athletic steering experience.



■ 20" M light alloy wheels Double-spoke style 699 M Bicolour Orbit Grey with mixed tyres and run-flat tyres, gloss-lathed, wheel size front 8J x 20 with 245/45 R20 tyres, wheel size rear 9.5J x 20 with 275/40 R20 tyres.

□ 21" M light alloy wheels Double-spoke style 718 M Bicolour Jet Black with mixed tyres and run-flat tyres, gloss-lathed, wheel size front 8.5J x 21 with 245/40 R21 tyres, wheel size rear 9.5J x 21 with 275/35 R21 tyres.

M40i/M40d EXTERIOR TRIM EQUIPMENT RANGES:

- Adaptive LED headlights
- 20" M double-spoke style 699 M aluminium wheels with mixed tyres and run-flat tyres
- M roof rails high-gloss Shadowline
- M High-gloss Shadowline exterior trim
- Adaptive M suspension
- M Sport brakes

M40i/M40d INTERIOR EQUIPMENT RANGES:

- Sport seats for driver and front passenger
- Sensatec perforated upholstery
- M leather steering wheel with M seam and opening on the 6 o'clock spoke
- Steptronic Sport transmission
- M Anthracite headliner
- Instrument panel in Sensatec
- M interior trim finishers in Aluminium Rhombicle dark with highlight trim finisher in Pearl Chrome
- BMW Live Cockpit Plus
- HiFi loudspeaker system

The availability of some equipment, functions, and digital services depends on engine variants or additional optional equipment. The offer structure as well as market and production availability may vary. For detailed information on availability, terms and costs, please contact your local BMW partner.

■ Standard equipment

□ Optional equipment

X3 M.



■ The M leather steering wheel with shift paddles provides a direct, athletic steering experience. The red M1/M2 buttons call up preset M Drive configurations.

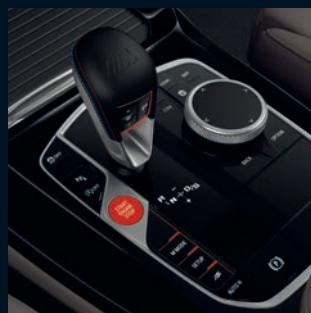

■ In the easy-to-reach centre console control panel, the M MODE button below the Start/Stop button allows you to change the contents of the display. The SETUP button offers even more choice for configuring the vehicle characteristics. It opens the menu for individual adjustments to the driving dynamics. Additional buttons switch individual assistance systems off or on.



□ The multi-adjustable M Sport seats with bucket seat character and partly integrated headrest provide excellent lateral support for you and your front passenger. In addition, the backrest width can be individually adjusted. Their special design with illuminated M logo highlights the vehicle's athletic capabilities.



■ Door sill finishers with the "X3 M" designation on chrome inserts in the front on the left and right.



■ 20" M light alloy wheels Double-spoke style 764 M Bicolour Orbit Grey with mixed tyres, gloss-lathed, front wheel size 9J x 20 with 255/45 ZR20 tyres, rear wheel size 10J x 20 with 265/45 ZR20 tyres.

X3 M EXTERIOR TRIM EQUIPMENT RANGES:

- Adaptive LED headlights
- 20" M double-spoke style 764 M Bicolour Orbit Grey light-alloy wheels with mixed tyres
- M Compound brakes
- M specific suspension
- M high-gloss Shadow Line
- M roof rails high-gloss Shadow Line
- M Servotronic
- Active M differential
- M Drive
- M xDrive

X3 M INTERIOR EQUIPMENT RANGES:

- Entry sills ("X3 M")
- Sport seats for driver and front passenger
- Leather Vernasca
- M anthracite headliner
- M interior trim finishers in Aluminium Rhombicle dark with highlight trim finisher in Pearl Chrome
- Harman Kardon Surround Sound System
- Ambient lighting
- M Steptronic transmission with Drivelogic

The availability of some equipment, functions, and digital services depends on engine variants or additional optional equipment. The offer structure as well as market and production availability may vary. For detailed information on availability, terms and costs, please contact your local BMW partner.

■ Standard equipment

□ Optional equipment

X3 M COMPETITION.



■ The multi-adjustable M Sport seats with bucket seat character and partly integrated headrest provide excellent lateral support for you and your front passenger. In addition, the backrest width can be individually adjusted. Their special design with illuminated M logo highlights the vehicle's athletic capabilities.



■ The M leather steering wheel with shift paddles provides a direct, athletic steering experience. The red M1/M2 buttons call up preset M Drive configurations.



□ The M Carbon mirror caps with M typical double-bridged design emphasise the powerful, sporty design of the vehicle.



■ The M high-gloss Shadow Line with extended contents includes the kidney grille frame and the air breather in Black high-gloss and tailpipe trims in Black Chrome.



■ 21" M light alloy wheels Double-spoke style 892 M Bicolour Jet Black with mixed tyres, forged, front wheel size 9.5J x 21 with 255/40 ZR21 tyres, rear wheel size 10J x 21 with 265/40 ZR21 tyres.

X3 M COMPETITION EXTERIOR TRIM EQUIPMENT RANGES:

- 21" M double-spoke style 892 M Bicolor black light alloy wheels with mixed tyres, forged
- M high-gloss Shadowline exterior trim with extended features
- M Sport exhaust system

X3 M COMPETITION INTERIOR EQUIPMENT RANGES:

- Entry sills ("X3 M Competition")
- M Sport seats
- M Merino leather with extended features
- M seat belts

The availability of some equipment, functions, and digital services depends on engine variants or additional optional equipment. The offer structure as well as market and production availability may vary. For detailed information on availability, terms and costs, please contact your local BMW partner.

■ Standard equipment

□ Optional equipment

X3 xDRIVE30e.

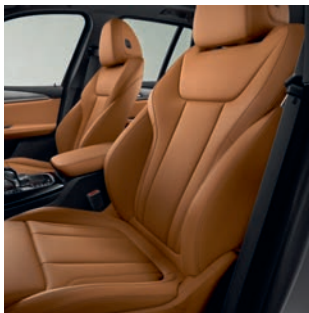

■ The Sport seats for driver and front passenger feature optimum support by means of various manual adjustment options.



■ The charging socket of the plug-in hybrid technology including charging status display is concealed behind the charging flap in the front left fender.



□ With the services of Connected Charging, you will be flexible and mobile with your plug-in hybrid at all times. Whether charge status, remaining range or charging history – stay on top of it all. The services will help you quickly find the next charging station and you can even pay with them while on the road.



■ 18" light alloy wheels V-spoke style 618 in Reflex Silver, wheel size 7J x 18, with 225/60 R18 tyres.



□ 21" BMW Individual light alloy wheels V-spoke style 726 I Bicolour, Orbit Grey with mixed tyres and run-flat tyres, gloss-lathed, wheel size front 8.5J x 21 with 245/40 R21 tyres, wheel size rear 9.5J x 21 with 275/35 R21 tyres.

X3 xDRIVE30e EXTERIOR TRIM EQUIPMENT RANGES:

- 18" V-spoke style 618 light alloy wheels
- LED headlights

X3 xDRIVE30e INTERIOR EQUIPMENT RANGES:

- Sensatec perforated
- Black high-gloss trim with Pearl Chrome finisher
- Sport seats for driver and front passenger
- Sport leather steering wheel
- BMW Live Cockpit Plus
- Stereo speaker system
- Automatic air conditioning
- Steptronic transmission
- Acoustic protection for pedestrians



EQUIPMENT HIGHLIGHTS.



□ The Comfort Access makes it possible to open all of the vehicle doors and the luggage compartment, without using the key. When approaching, the welcome greeting is activated even before the doors unlock automatically.

□ The M high-gloss Shadow Line¹ includes numerous equipment details in Black high-gloss: side frame trim strips, window recess finishers, exterior mirror caps, mirror base and triangle, B-pillar trim panels and window guide bars on the rear doors.



□ In laser high-beam mode, the Adaptive BMW Laserlight illuminates a range of up to 650 m, nearly twice as far as that of conventional headlights. Better visibility in the dark significantly increases safety. Blue accents and the "BMW Laser" lettering in the headlight also underline the technological standards and the sportiness of the vehicle.



□ The adaptive suspension makes it possible to ideally adjust the damper characteristics to suit any given driving situation, improving roll comfort and driving dynamics. In addition to the standard COMFORT setting for increased driving comfort, the SPORT program can also be selected for athletic damper settings.



□ The adaptive LED headlights include low-beam and no-dazzle high-beam headlights (BMW Selective Beam) and turn indicators with full LED technology. The equipment also features cornering lights, daytime running lights and Adaptive headlights with variable light control for excellent illumination of the road ahead and better visibility in the dark.

■ Standard equipment □ Optional equipment

¹ Standard for M40i and M40d.

The availability of some equipment, functions, and digital services depends on engine variants or additional optional equipment. The offer structure as well as market and

production availability may vary. For detailed information on availability, terms and costs, please contact your local BMW partner.

EQUIPMENT HIGHLIGHTS.



□ The Instrument panel in Sensatec¹ lends the interior of the vehicle a highly exclusive atmosphere. The artificial leather is applied directly to a semi-rigid foam, and features an impressively soft surface. The wear-resistant material around the door panels on the front and rear features attractive double-lap seams.



□ When open, the Panorama glass roof provides a great deal of fresh air. Closed, it creates a bright, light-flooded atmosphere in the interior. It opens and closes completely automatically at the push of a button or with the vehicle key, and is equipped with slide and lift functions, roller sunblind and wind deflector.

□ The full-colour BMW Head-up Display² projects all information relevant to the journey directly into the driver's field of vision.



□ Harman Kardon surround sound system with 464-watt digital amplifier, nine channels, vehicle-specific equalizer and 16 speakers.



■ The adjustable sport seats for the driver and front passenger feature numerous manual adjustment options, including fore-and-aft position and backrest angle. Thanks to larger seat and backrest bolsters, and well-defined side bolsters, they provide excellent ergonomics and a high degree of lateral support.

■ Standard equipment □ Optional equipment

¹ Standard for M40i and M40d.

² The information in the BMW Head-Up Display is not fully visible when viewed through polarised sunglasses. Content shown will depend on the equipment options chosen. Further optional equipment is required to display specific items.

The availability of some equipment, functions, and digital services depends on engine variants or additional optional equipment. The offer structure as well as market and production availability may vary. For detailed information on availability, terms and costs, please contact your local BMW partner.

EQUIPMENT HIGHLIGHTS.

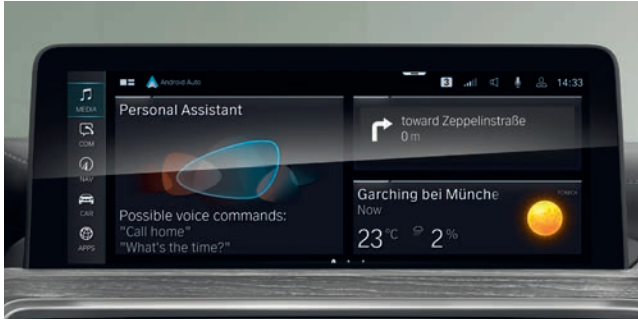

□ The BMW Live Cockpit Professional with navigation function includes two high-quality displays consisting of a high-resolution 12.3" Control Display that can be operated by touch and a fully digital 12.3" instrument display. The BMW Operating System 7 can also be operated via the iDrive Touch Controller⁴.



□ BMW Maps with Connected Navigation and Connected Parking, Connected Music, Smartphone Integration³ incl. Apple CarPlay and Android Auto and In-Car Experiences – the Connected Package Professional provides extensive networking capability for your BMW. You benefit from increased comfort and seamless integration of your smartphone apps.



■ The latest software version always on board. With Remote Software Upgrade, your BMW will always be up to date. You can simply download the upgrades via the My BMW App or via the SIM card installed in the vehicle and then install them. In this way, other available functions in your BMW are also activated.

□ "Alexa, add teabags to my shopping list." "Alexa, what is the weather like in Munich?" With the Amazon Alexa Car Integration^{1,2}, using the voice service in your car is effortless, just as you are used to at home. Alexa's responses are also shown as visual feedback on your vehicle's control display.

■ Why go without the features of your smartphone in your BMW when you can continue operating it as usual? Smartphone integration³ connects your smartphone wirelessly to your vehicle via Apple CarPlay and Android Auto. This allows you to conveniently use functions and various apps directly via the control display.

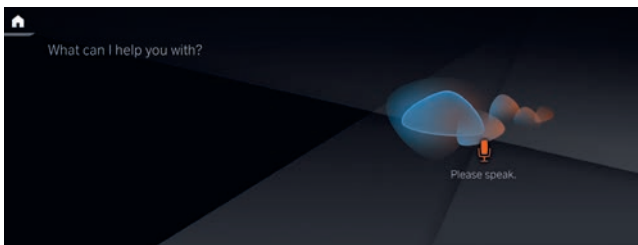

□ Wouldn't it be incredible if your BMW was also your personal vehicle expert? Communicate with your vehicle using the BMW Intelligent Personal Assistant. Say natural commands to operate numerous vehicle functions. It can also explain topics about your vehicle and helps you to get to know your BMW even better.

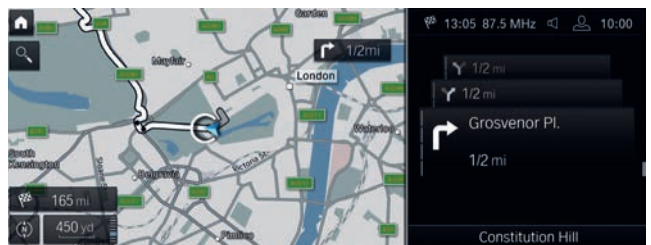
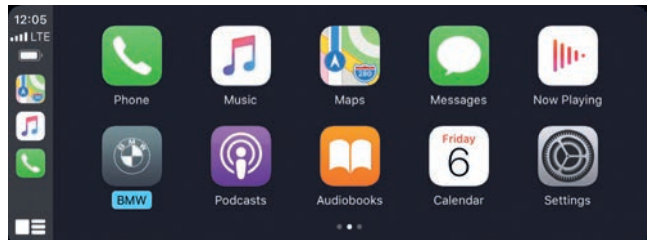

□ During planning and preparation, while driving and even while parking: BMW Maps guarantees you an outstanding navigation experience. Make your journey even more comfortable and personal – thanks to the intuitive operation and navigation perfectly tuned to the driver.

■ Standard equipment □ Optional equipment

¹ An Amazon account is required for the integration of Amazon Alexa Car Integration.

² Amazon, Alexa and all associated logos are trademarks of Amazon.com, Inc. or its affiliates.

³ Smartphone Integration is permanently available in the vehicle. It includes Apple CarPlay and Android Auto. Android Auto linking is only possible in conjunction with a BMW Live Cockpit. Due to possible future technical developments (e.g. of mobile phones), the usability of the Apple CarPlay or Google Android Auto service cannot be

guaranteed permanently. CarPlay is a trademark of Apple Inc. Android Auto is a trademark of Google LLC.

⁴ For this vehicle model, the touch functionality for the iDrive controller can currently not be offered.

The availability of some equipment, functions, and digital services depends on engine variants or additional optional equipment. The offer structure as well as market and production availability may vary. For detailed information on availability, terms and costs, please contact your local BMW partner.

EQUIPMENT HIGHLIGHTS.

□ The Driving Assistant¹ safety package includes Front Collision Warning with brake intervention, Manual Speed Limit Assist including Speed Limit Display with no-overtaking indicator and pre-warning as well as rear crossing traffic warning. Lane Departure Warning and Lane Change Warning with active return, as well as rear collision warning complete the features.

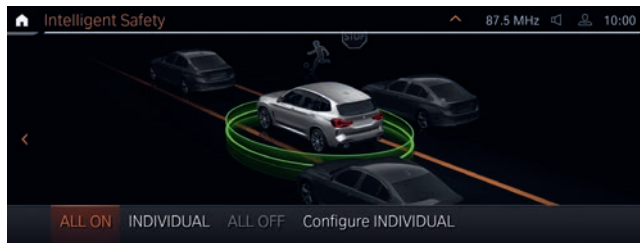
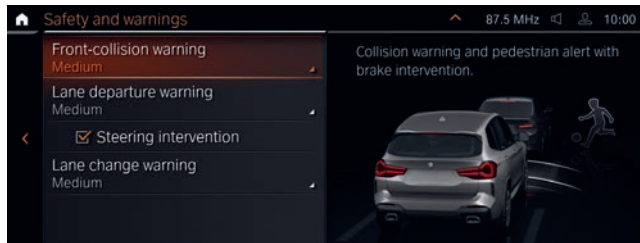

□ Driving Assistant Professional¹ offers optimum comfort and safety during critical or monotonous traffic situations. Apart from the contents of the Driving Assistant, it also includes Steering and Lane Control Assistant with extended functions, Emergency Stop Assistant and Lane Keeping Assistant with active side collision protection.

□ The Assisted View provides real-time information on the vehicle surroundings collected by various assistance systems. Thanks to an animated 3D display in the instrument cluster, you can clearly see how your vehicle perceives the current traffic situation and thus understand how the systems work.



■ The Parking Assistant² makes parking the vehicle easier. The Reversing Assist Camera and Reversing Assistant support the driver when reversing. Active Park Distance Control offers increased protection against damage caused by parking. Parking Assistant parks the vehicle automatically, parallel or perpendicular to the street, and leaves parallel parking spaces.



□ The Parking Assistant Plus² makes parking and manoeuvring the vehicle easier. It features among others the Surround View system including Top View, Panorama View, Remote 3D View, as well as a lateral parking aid, the emergency braking function Active Park Distance Control, Parking Assistant with longitudinal and lateral guidance and Reversing Assistant.

□ The BMW Drive Recorder, consisting of the event and crash recorder, allows you to record a video from the vehicle environment and play the video on the Control Display or, via USB export, on your device. Important vehicle information such as speed and GPS position are stored synchronously with the video.

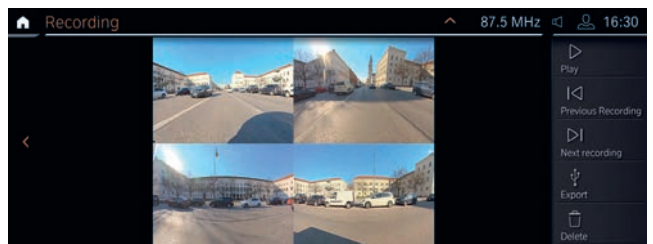

■ Standard equipment □ Optional equipment

¹ Function may be limited in darkness, fog or bright glare.

² The driver is responsible for constantly monitoring the automated parking procedure in accordance with local road laws.

The availability of some equipment, functions, and digital services depends on engine variants or additional optional equipment. The offer structure as well as market and production availability may vary. For detailed information on availability, terms and costs, please contact your local BMW partner.

EQUIPMENT HIGHLIGHTS. PERFORMANCE.

□ The M anthracite headliner¹ together with body pillars and grab handles also lined in anthracite ensure a sporty ambience in the interior.



□ The M high-gloss Shadow Line with extended features² includes equipment features in Black: kidney grille frame and BMW kidney grille in black high-gloss and tailpipe trims in Black Chrome.



□ Adapted to the vehicle's high dynamic potential, the powerful M Sport brake² also allows a very sporty driving style and at the same time excellent braking. The fixed calipers are exclusively finished in high-gloss Red with M labelling to provide a striking visual feature. The front aluminium brake calipers are each equipped with four pistons, the rear floating calipers with a single piston each. The particularly large, internally ventilated, lightweight discs guarantee an exceptional braking power.



□ The M Sport brake³ has four-piston fixed callipers at the front and single-piston floating callipers at the rear in blue with the M designation and features large brake discs to ensure an outstanding braking performance.



□ The M Shadow Line lights give the main headlights a sporty look with all chrome elements finished in Black. The dark details perfectly complement the optionally available M high-gloss Shadow Line with extended features.

■ Standard equipment □ Optional equipment

¹ Series for M Sport package, M40i and M40d.

² Only available for M Sport package, M40i and M40d.

³ Only available for M Sport package. Standard for M40i and M40d.

The availability of some equipment, functions, and digital services depends on engine variants or additional optional equipment. The offer structure as well as market and production availability may vary. For detailed information on availability, terms and costs, please contact your local BMW partner.

EQUIPMENT HIGHLIGHTS. PERFORMANCE.

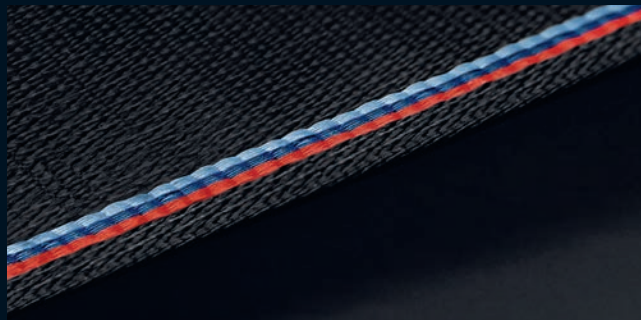

□ The M seat belts¹ with belt tensioner and belt force limiter boast an exquisite stitched highlight in the classic M colours.



□ The multi-adjustable M Sport seats¹ with bucket seat character and 'partly integrated headrest provide excellent lateral support for you and your front passenger. In addition, the backrest width can be individually adjusted. Their special design with black M logo highlights the vehicle's athletic capabilities.

□ The Adaptive M suspension² can be electrically adjusted at any time to suit the road and driving conditions. You can also adjust the suspension characteristics via the Driving Experience Control to enable your preferred driving style at the time – from comfortable to extremely athletic with markedly agile handling.



□ The 8-speed Steptronic Sport transmission³ offers incredibly sporty gear changes. Whether automatic or manual using the selector lever or gearshift paddles – for comfortable coasting or incredibly dynamic driving. In SPORT mode and with the selector lever in the left-hand S/M position, the gear shifts are configured for the maximum performance.

■ Standard equipment □ Optional equipment

¹ Only available for M Sport package, M40i and M40d.

² Only available for M40i and M40d.

³ Only available for M Sport package. Standard for M40i and M40d.

The availability of some equipment, functions, and digital services depends on engine variants or additional optional equipment. The offer structure as well as market and production availability may vary. For detailed information on availability, terms and costs, please contact your local BMW partner.

EXTERIOR COLOUR WORLD.



□ Non-metallic 300 Alpine White¹

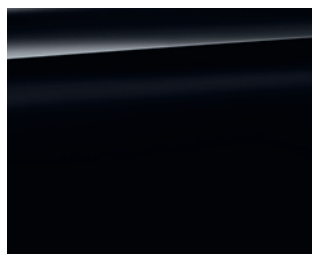

■ Non-metallic 668 Black



□ Metallic A96 Mineral White²



□ Metallic A90 Sophisto Grey Brilliant Effect²



□ Metallic 475 Black Sapphire²

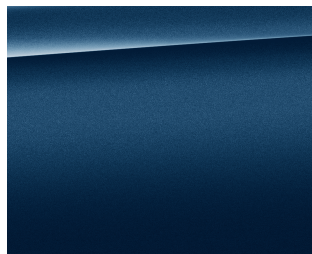

□ Metallic WC1M Phytonic blue²



□ BMW Individual C57 Aventurine Red metallic³

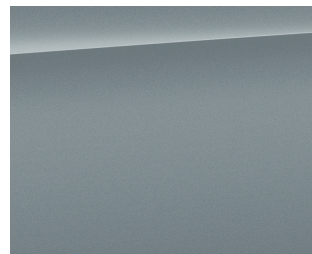

□ Metallic C4P M Brooklyn Grey³

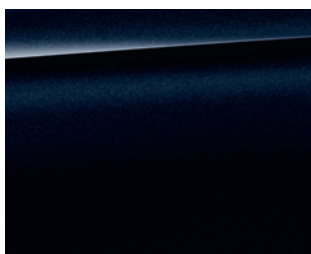

□ Metallic 416 M Carbon Black³

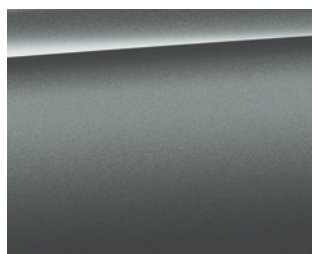

□ Metallic C4W Skyscraper Grey

BMW INDIVIDUAL

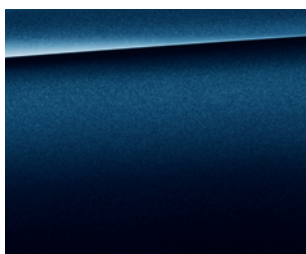

□ BMW Individual C3Z Tanzanite Blue metallic²

BMW INDIVIDUAL SPECIAL PAINTWORK



□ BMW Individual special paintwork Frozen Brilliant White metallic



□ BMW Individual special paintwork Frozen Deep Grey metallic



□ BMW Individual special paintwork Frozen Black metallic



□ BMW Individual special paintwork Frozen Marina Bay Blue metallic

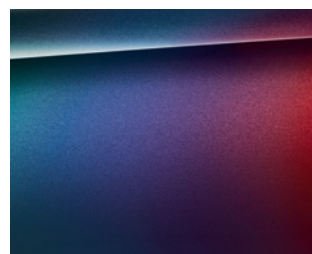

□ BMW Individual special paintwork Frozen Marina Bay Blue metallic

■ Standard equipment □ Optional equipment

[Colour samples] These colour samples are intended as an initial guide to the colours and materials available for your BMW. However, experience has shown that printed versions of paint, upholstery and interior trim colours cannot in all cases faithfully reproduce the appearance of the original colour. Please discuss your preferred colour choices with your BMW partner or in your dealership. There you can also see original samples and be assisted with special requests.

¹ Standard for M Sport package, M40i and M40d.

² Also available for M Sport package, M40i and M40d.

³ Only available for M Sport package, M40i and M40d.

The availability of some equipment, functions, and digital services depends on engine variants or additional optional equipment. The offer structure as well as market and production availability may vary. For detailed information on availability, terms and costs, please contact your local BMW partner.



Make an individual statement. BMW Individual special paintwork offers you countless possibilities to highlight the exclusivity of your BMW X3 Series. Simply scan the QR code or ask your Authorised BMW Retailer.

INTERIOR COLOURS.

UPHOLSTERY COLOURS



■ Sensatec perforated KHFY Canberra Beige



■ Sensatec perforated KHRI Cognac

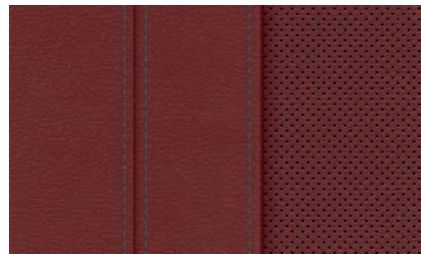

■ Sensatec perforated KHG7 Tacora Red

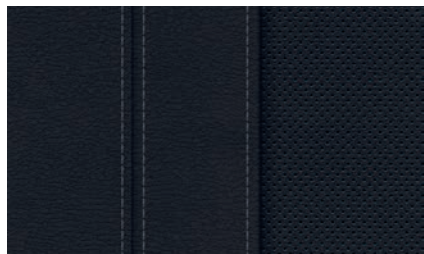

■ Sensatec perforated KHSW Black

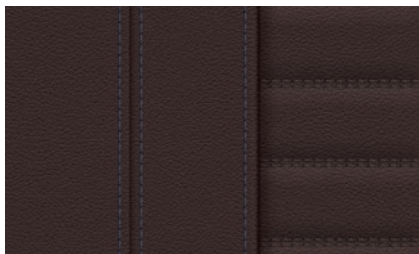

□ Leather 'Vernasca' MAMU Mocha with decorative stitching

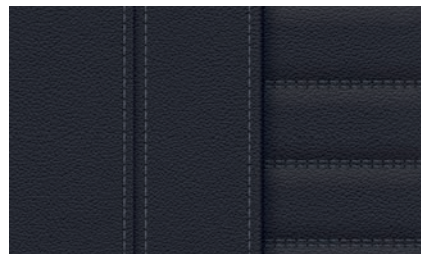

□ Leather 'Vernasca' MAH7 Black decorative stitching

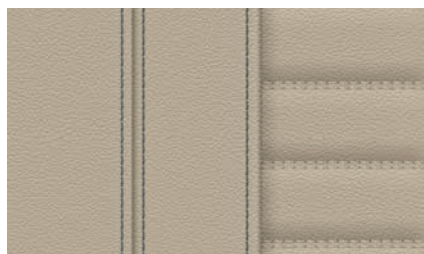

□ Leather 'Vernasca' MAOI Oyster with decorative stitching¹

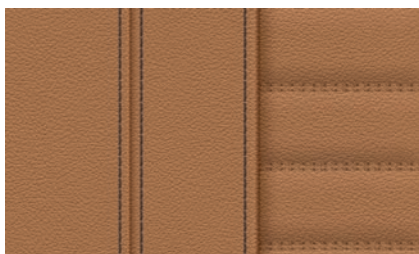

□ Leather 'Vernasca' MAPQ Cognac with decorative stitching¹

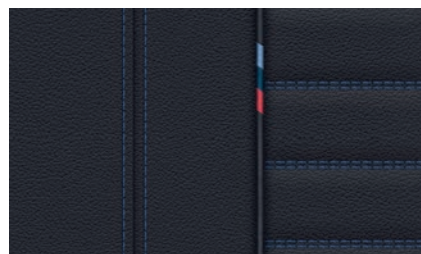

□ Leather 'Vernasca' MANL Black with Blue contrast stitching¹

BMW INDIVIDUAL

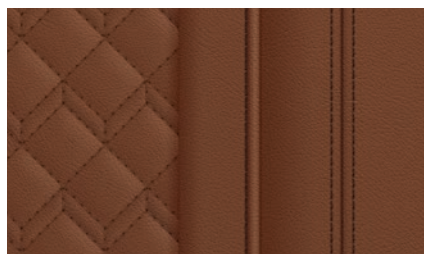

□ BMW Individual extended leather trim 'Merino' VATQ Tartufo²

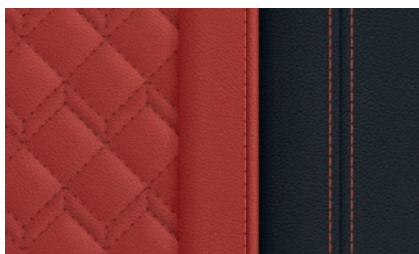

□ BMW Individual extended leather trim 'Merino' VAHZ Fiona Red/Black²

■ Standard equipment □ Optional equipment

¹ Only available for M Sport package, M40i and M40d.

² Not available for M Sport package.

The availability of some equipment, functions, and digital services depends on engine variants or additional optional equipment. The offer structure as well as market and production availability may vary. For detailed information on availability, terms and costs, please contact your local BMW partner.

Please note that even normal long- or short-term use can lead to unrecoverable upholstery damage. This can be caused in particular by non-colourfast clothing. Please note that the interior colour depends on the selected upholstery colour.

INTERIOR COLOURS.

INTERIOR TRIM FINISHERS



■ Interior trim finishers black high-gloss with highlight trim finisher Pearl Chrome

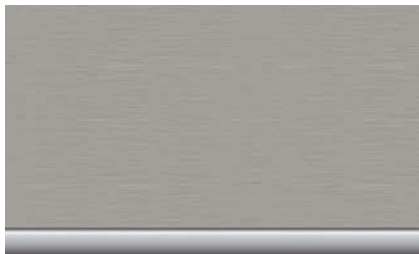

□ Interior trim finishers Aluminium fine cutting with highlight trim finisher Pearl Chrome

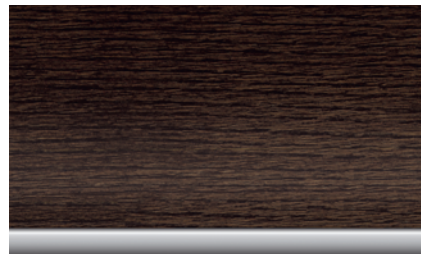

□ Fine-wood trim Oak dark high-gloss with highlight trim finisher Pearl Chrome



□ Fine-wood trim Ash Trunk open-pored with highlight trim finisher Pearl Chrome

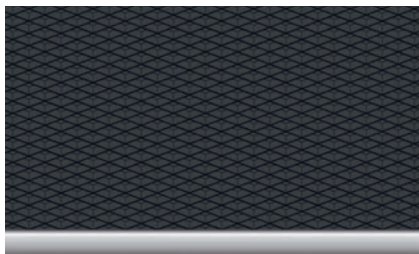

■ M interior trim finishers Aluminium Rhombicle dark with highlight trim finisher Pearl Chrome¹

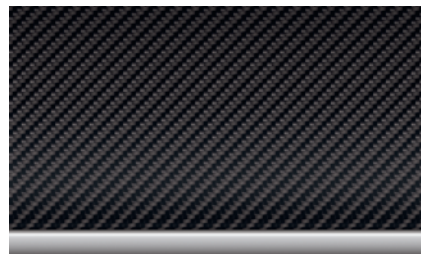

□ M interior trim finishers 'Carbon Fibre' with highlight trim finisher Pearl Chrome¹

BMW INDIVIDUAL



□ BMW Individual interior trim finishers piano finish Black

■ Standard equipment □ Optional equipment

¹ Only available for M Sport package, M40i and M40d. The availability of some equipment, functions, and digital services depends on engine variants or additional optional equipment. The offer structure as well as market and production availability may vary. For detailed information on availability, terms and costs, please contact your local BMW partner.

Please note that even normal long- or short-term use can lead to unrecoverable upholstery damage. This can be caused in particular by non-colourfast clothing. Please note that the interior colour depends on the selected upholstery colour.

WHEELS AND TYRES.

■ 18" light alloy wheels V-spoke style 618 in Reflex Silver, wheel size 7J x 18, with 225/60 R18 tyres.¹



□ 19" light alloy wheels V-spoke style 692 Bicolour Ferric Grey, gloss-lathed, wheel size 7.5J x 19 with 245/50 R19 tyres.¹



■ 19" M light alloy wheels Double-spoke style 887 M Bicolour Black Grey, 7.5J x 19 with 245/50 R19 tyres.²



□ 20" light alloy wheels Y-spoke style 695 Bicolour Orbit Grey with mixed tyres, gloss-lathed, front 8J x 20 with 245/45 R20 tyres, rear 9.5J x 20 with 275/40 R20 tyres.¹



□ 19" light alloy wheels Y-spoke style 693, Ferric Grey, gloss-lathed, wheel size 7.5J x 19 with 245/50 R19 tyres.¹



□ 19" aerodynamic wheels 842 Bicolour Jet Black uni, gloss-lathed, wheel size 7.5J x 19 with 245/50 R19 tyres.¹



□ 20" M light alloy wheels Double-spoke style 699 M Orbit Grey with mixed tyres, gloss-lathed, front 8J x 20 with 245/45 R20 tyres, rear 9.5J x 20 with 275/40 R20 tyres.³



□ 20" M light alloy wheels Double-spoke style 699 M Jet Black uni with mixed tyres, front 8J x 20 with 245/45 R20 tyres, rear 9.5J x 20 with 275/40 R20 tyres.³



□ 20" M light alloy wheels Double-spoke style 787 M Orbit Grey with mixed tyres, gloss-lathed, front 8J x 20 with 245/45 R20 tyres, rear 9.5J x 20 with 275/40 R20 tyres.³



□ 21" M light alloy wheels Double-spoke style 718 M Bicolour Jet Black with mixed tyres and run-flat tyres, gloss-lathed, wheel size front 8.5J x 21 with 245/40 R21 tyres, wheel size rear 9.5J x 21 with 275/35 R21 tyres.⁴



□ 21" BMW Individual light alloy wheels V-spoke style 726 I Bicolour, Orbit Grey with mixed tyres and run-flat tyres, gloss-lathed, wheel size front 8.5J x 21 with 245/40 R21 tyres, wheel size rear 9.5J x 21 with 275/35 R21 tyres.

■ Standard equipment □ Optional equipment

¹ Not available for M Sport package, M40i and M40d.
² Only available for M Sport package.
³ Only available for M Sport package, M40i and M40d.
⁴ Only available for M40i and M40d.

The availability of some equipment, functions, and digital services depends on engine variants or additional optional equipment. The offer structure as well as market and production availability may vary. For detailed information on availability, terms and costs, please contact your local BMW partner.

EXTERIOR COLOUR WORLD. BMW M AUTOMOBILES.



■ Non-metallic 300 Alpine White



□ Solid paint C4H M Sao Paulo Yellow

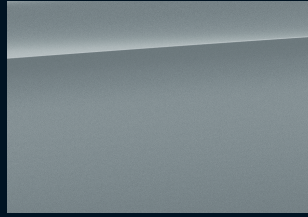

□ Metallic C4P M Brooklyn Grey



□ Metallic A90 Sophisto Grey Brilliant Effect



□ Metallic 475 Black Sapphire

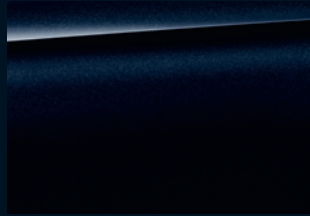

□ Metallic 416 M Carbon Black



□ Metallic C1K M Marina Bay Blue



□ Metallic C3G M Toronto Red

BMW INDIVIDUAL SPECIAL PAINTWORK

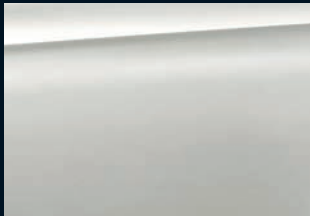

□ BMW Individual special paintwork Frozen Brilliant White metallic



□ BMW Individual special paintwork Frozen Deep Grey metallic



□ BMW Individual special paintwork Frozen Marina Bay Blue metallic

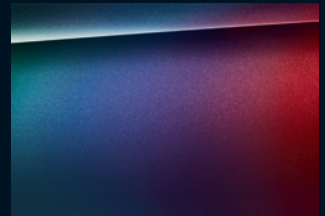

□ BMW Individual 490 special paintwork (up to 150 paints available)



Make an individual statement. BMW Individual special paintwork offers you countless possibilities to highlight the exclusivity of your BMW X3 Series. Simply scan the QR code or ask your Authorised BMW Retailer.

WHEELS AND TYRES. BMW M AUTOMOBILES.



■ 20" M light alloy wheels Double-spoke style 764 M Bicolour Orbit Grey with mixed tyres, gloss-lathed, front wheel size 9J x 20 with 255/45 ZR20 tyres, rear wheel size 10J x 20 with 265/45 ZR20 tyres.¹

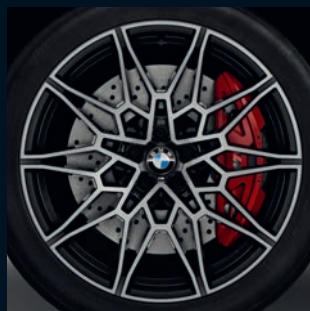

■ 21" M light alloy wheels Double-spoke style 892 M Bicolour Jet Black with mixed tyres, forged, front wheel size 9.5J x 21 with 255/40 ZR21 tyres, rear wheel size 10J x 21 with 265/40 ZR21 tyres.²



□ 21" M light alloy wheels V-spoke style 765 M Bicolour Jet Black with mixed tyres, gloss-lathed, front wheel size 9.5J x 21 with 255/40 ZR21 tyres, rear wheel size 10J x 21 with 265/40 ZR21 tyres.

- Standard equipment
- Optional equipment

[Colour samples] These colour samples are intended as an initial guide to the colours and materials available for your BMW. However, experience has shown that printed versions of paint, upholstery and interior trim colours cannot in all cases faithfully reproduce the appearance of the original colour. Please discuss your preferred colour choices with your BMW partner or in your dealership. There you can also see original samples and be assisted with special requests.

¹ Not available for Competition models.

² Only available for Competition models.

The availability of some equipment, functions, and digital services depends on engine variants or additional optional equipment. The offer structure as well as market and production availability may vary. For detailed information on availability, terms and costs, please contact your local BMW partner.

INTERIOR COLOURS. BMW M AUTOMOBILES.

UPHOLSTERY COLOURS



■ Leather 'Vernasca' MAOI Oyster with decorative stitching



■ Leather 'Vernasca' MAH7 Black decor stitching



□ Leather/Alcantara combination HDJA Black, with contrast stitching Midrand Beige¹

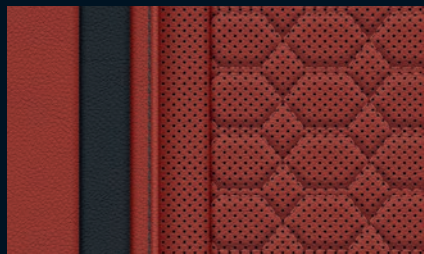

□ Leather 'Merino' LKDA with extended contents Sakhir Orange

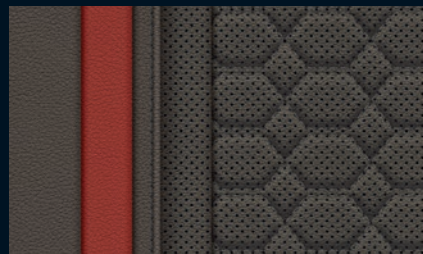

□ Leather 'Merino' LKHV with extended contents Adelaide Grey



□ Leather 'Merino' LKSW with extended contents Black²

BMW INDIVIDUAL

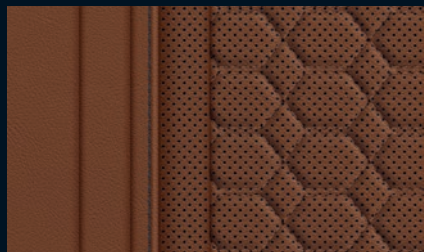

□ BMW Individual extended leather trim 'Merino' VATQ Tartufo

INTERIOR TRIM FINISHERS

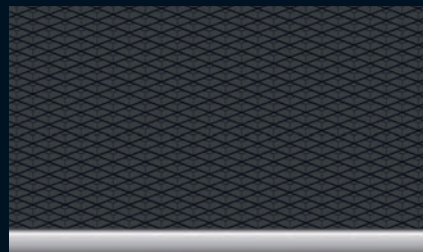

■ M interior trim finishers Aluminium Rhombicle dark with highlight trim finisher Pearl Chrome



□ Fine-wood trim Ash Trunk open-pored with highlight trim finisher Pearl Chrome

BMW INDIVIDUAL



□ M interior trim finishers 'Carbon Fibre' with highlight trim finisher Pearl Chrome

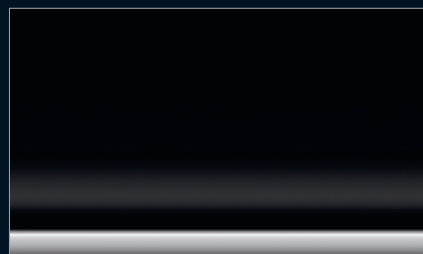

□ BMW Individual interior trim finishers piano finish Black

■ Standard equipment □ Optional equipment

¹ Only available for Competition models.

² Standard for Competition models.

The availability of some equipment, functions, and digital services depends on engine variants or additional optional equipment. The offer structure as well as market and production availability may vary. For detailed information on availability, terms and costs, please contact your local BMW partner.

Please note that even normal long- or short-term use can lead to unrecoverable upholstery damage. This can be caused in particular by non-colourfast clothing. Please note that the interior colour depends on the selected upholstery colour.



ORIGINAL BMW ACCESSORIES.

Intensive driving experiences, even further enhanced: Original BMW accessories are the best match for an original BMW. Whether wheels and tyres, transport and luggage compartment solutions, interior accessories, communication, information and technology, charging accessories or M performance parts, with original BMW accessories you'll find exactly the individual solution that will allow you to discover driving pleasure as if for the first time.



WHEELS AND TYRES.

With original BMW complete wheels, you'll reach your destination safely, and emphasise the sporty appearance of your BMW from the very first glance. But what you don't immediately realise is that they are precisely tailored to your BMW, are subject to very stringent tests with intensive material and function checks, and have been developed in close collaboration with leading tyre manufacturers – individually tuned to the driving dynamics and design language of each individual BMW model.

TRANSPORT AND LUGGAGE COMPARTMENT SOLUTIONS.

Original BMW Accessories offer you a wide range of transport and luggage compartment solutions. In line with your personal preferences and interests, you can use them to create additional space whenever and wherever you need it. Whether carrier systems or accessories for the luggage compartment, you can always rely on original BMW accessories to be precisely tailored to your BMW, and easy to use.



INTERIOR ACCESSORIES.

A perfect fit: all original BMW accessory products for the interior help to design the interior of your BMW to fully meet your personal preferences. In addition to the excellent functionality of original BMW accessories, you are also always choosing attractive BMW design alongside extraordinary craftsmanship and material quality – combined with an ambience that will excite you every time you drive.



COMMUNICATION, INFORMATION AND TECHNOLOGY.

Cutting-edge functions and features for maximum freedom and flexibility: Original BMW accessories for communication, information and technology are always at your side. Whether you value optimum availability by phone or the best sound, the innovative original BMW accessories will have the right solution for you. You'll always enjoy a good connection and custom entertainment, wherever your journey takes you.

CHARGING ACCESSORIES.

Regardless of where and how you want to charge your new BMW, original BMW charging accessories offer you tailor-made products and services. You can charge your BMW at any domestic socket using the BMW Flexible Fast Charger or, for even more convenience, at a BMW Wallbox from original BMW accessories; what's more, there's also a widespread network of public charging points available for when you're on the road. Innovative Connected Charging services show charging stations in your BMW's information display, for example, or enable you to easily start pre-conditioning your vehicle just using your smartphone.



M PERFORMANCE PARTS.

With M performance parts, you can experience BMW's motorsport DNA with fascinating intensity, even off the racetrack. A wide range of technical and visual components makes outstanding technology a visible and tangible experience. Exclusive materials and first-rate quality guarantee flawless dynamism. Experience inspiring maximum product performance: individual, expressive and uncompromising.

The availability of the equipment shown and described may vary on a market-specific basis. Your local BMW partner will be happy to advise you on the full range of original BMW accessories.

Discover the whole range of original BMW accessories and the BMW M performance parts product portfolio.



TECHNICAL VALUES.

BMW X3		xDrive20i ⁹ with mild hybrid technology	xDrive30i ⁹ with mild hybrid technology	xDrive30e ¹⁰	M40i ⁹ with mild hybrid technology	xDrive20d ⁹ with mild hybrid technology	xDrive30d ⁹ with mild hybrid technology	M40d ⁹ with mild hybrid technology
Weight and volume								
EC unladen weight ¹	kg	1875	1885	2065	1985	1915	2010	2080
Maximum permissible weight	kg	2410	2450	2600	2485	2500	2550	2580
Luggage capacity	l	550–1600	550–1600	450–1500	550–1600	550–1600	550–1600	550–1600
Tank capacity, approx.	l	65	65	50	65	68	68	68
Output and torque²								
Cylinders/displacement	Number/cm ³	4/1998	4/1998	4/1998	6/2998	4/1995	6/2993	6/2993
MAXIMUM OUTPUT								
► Combined complete vehicle drive	kW (hp)	–	–	215 (292)	–	–	–	–
► Combustion engine	kW (hp)/rpm	135 (184)/ 5000–6500	180 (245)/ 5000–6500	135 (184)/ 5000–6500	265 (360)/ 5200–6500	140 (190)/ 4000	210 (286)/ 4400	250 (340)/ 4400
► With mild hybrid technology	kW (hp)	+8 (11)	+8 (11)	–	+8 (11)	+8 (11)	+8 (11)	+8 (11)
MAXIMUM TORQUE								
► Combined complete vehicle drive	Nm	–	–	420	–	–	–	–
► Combustion engine	Nm/ rpm	300/ 1350–4000	350/ 1560–4800	300/ 1350–4000	500/ 1900–5000	400/ 1750–2500	650/ 1500–2500	700/ 1750–2250
Lithium-ion high-voltage battery								
Net battery capacity	kWh	–	–	10.8	–	–	–	–
Charging time (0–100 %) ³	h	–	–	3.7	–	–	–	–
Power transmission								
Type of drive	–	All-wheel	All-wheel	All-wheel	All-wheel	All-wheel	All-wheel	All-wheel
Standard transmission	–	8-speed Steptronic	8-speed Steptronic	8-speed Steptronic	8-speed Steptronic Sport	8-speed Steptronic	8-speed Steptronic	8-speed Steptronic Sport
Driving performance								
Top speed	km/h	215	235	210	250 ⁸	213	245	250 ⁸
Top electric speed	km/h	–	–	135	–	–	–	–
Acceleration 0–100 km/h	s	8.4	6.6	6.1	4.9	7.9	5.7	4.9
Consumption, pollutant emissions and range								
Exhaust emissions standard (type-certified)	–	EU6d	EU6d	EU6d	EU6d	EU6d	EU6d	EU6d
WLTP ^{2, 4, 6}								
► Combined consumption, PHEV weighted	l/100 km	8.4–7.6	8.5–7.6	2.6–2.0	9.5–8.8	6.5–5.8	7.0–6.2	7.3–6.6
► Combined CO ₂ emissions, PHEV weighted	g/km	192–172	194–173	59–45	216–199	171–151	183–162	192–173
► Combined weighted power consumption ⁵	kWh/100 km	–	–	20.5–18.9	–	–	–	–
► Electric range, EAER combined ⁷	km	–	–	42–50	–	–	–	–
Wheels/tyres								
Standard wheels	–	225/60 R18 104 W XL	225/60 R18 104 W XL	225/60 R18 104 W XL	Front: 245/45 R20 103 W XL Rear: 275/40 R20 106 W XL	225/60 R18 104 W XL	225/60 R18 104 W XL	Front: 245/45 R20 103 W XL Rear: 275/40 R20 106 W XL

The figures for driving performance, fuel consumption and CO₂ emissions refer to vehicles with standard transmission.

¹ The EC unladen weight refers to a vehicle with standard equipment and does not include any optional extras. The unladen weight includes a 90% full tank and a driver weight of 75 kg. Optional equipment may affect the weight of the vehicle, the payload and the top speed if the selected equipment has an impact on the vehicle's aerodynamics.

² Performance data of petrol engines apply to vehicles using RON 98 fuel. Fuel consumption data apply to vehicles using reference fuels in accordance with EU Regulation 715/2007. Unleaded RON 91 and higher with a maximum ethanol content of 10% (E10) may also be used. BMW recommends RON 95 super unleaded petrol.

³ Dependent on the local electricity infrastructure. Stated charging time based on an AC charging output of 3.7 kW.

⁴ Official data for fuel consumption, CO₂ emissions, power consumption and electric range were determined in accordance with the prescribed measuring procedure and correspond to European Regulation (EC) 715/2007 in the applicable version. In the event of ranges, data determined as per WLTP takes into account any optional equipment (available on the German market in this case). For vehicles that have been newly type approved since 1 January 2021, only the official data according to WLTP exist. For more information about NEDC and WLTP measuring procedures visit www.bmw.com/wltp

⁵ The combined energy consumption depends on the selected wheel and tyre sizes.

⁶ From 1 September 2017, certain new vehicles are tested according to the Worldwide Harmonised Light Vehicles Test Procedure (WLTP) before type approval is granted – WLTP provides a new, more realistic way of measuring fuel consumption, and CO₂ emissions. As of 1 September 2018, WLTP will replace the New European Driving Cycle (NEDC), the current test procedure. Based on the more realistic test conditions, in many cases the fuel consumption and CO₂ emissions are higher than if they had been measured according to the NEDC.

⁷ Range depends on various factors, in particular: individual driving style, route characteristics, outside temperature, heating/air conditioning, pre-conditioning.

⁸ Electronically limited.

⁹ This engine version is not available in all countries. For further information, please contact your local BMW Partner.

¹⁰ At temperatures below freezing, the fully electric drive system on this plug-in hybrid is only available after a few kilometres of driving, once the battery has heated to operational temperature.

TECHNICAL VALUES.

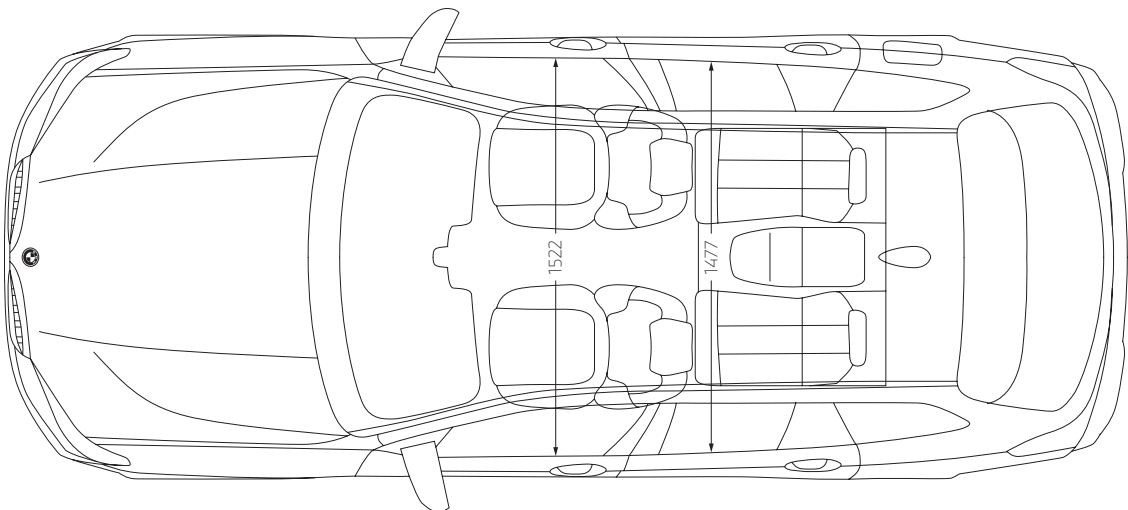
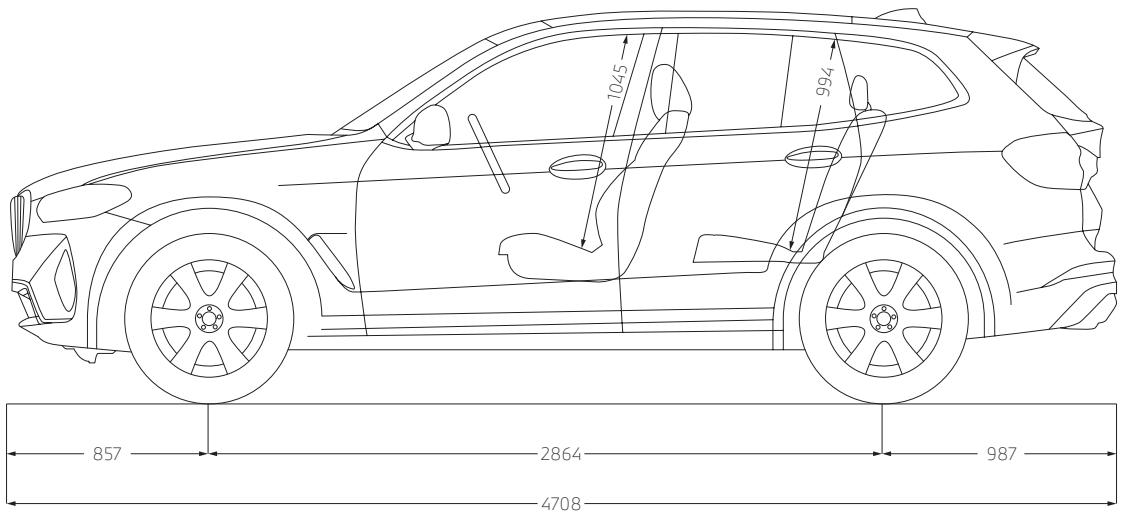
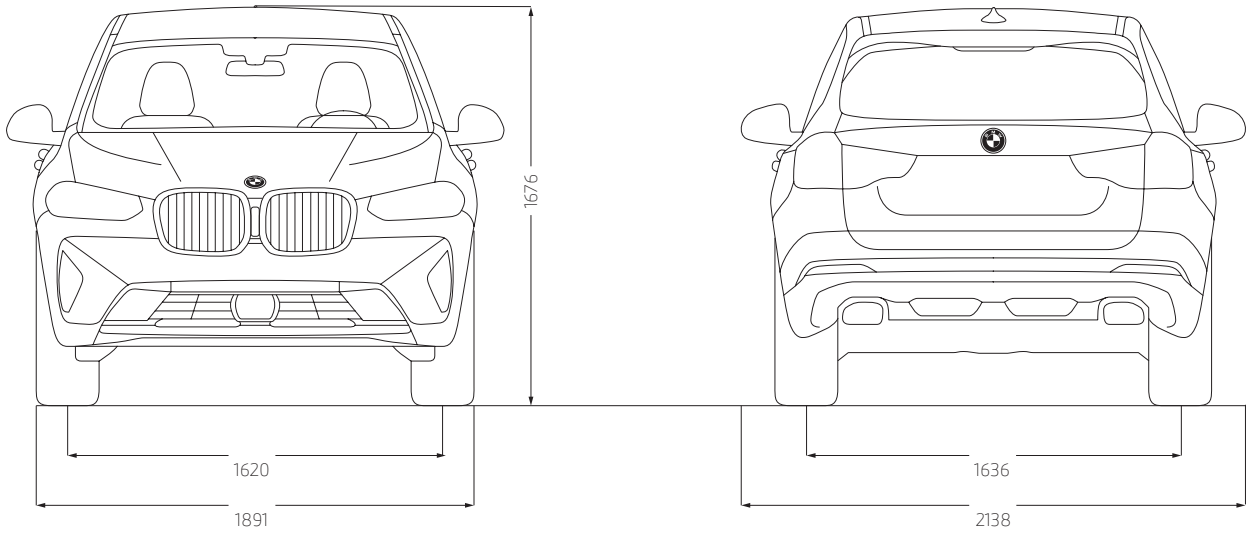

TECHNICAL VALUES. BMW M AUTOMOBILES.

BMW X3 M		X3 M Competition
Weight and volume		
Unladen weight EC ¹	kg	2085
Maximum permissible weight	kg	2500
Luggage capacity	l	550–1600
Tank capacity, approx.	l	65
Output and torque²		
Cylinders/displacement	Number/cm ³	6/2993
Maximum output	kW (hp)/rpm	375 (510)/6250
Maximum torque	Nm/rpm	650/2750–5500
Power transmission		
Type of drive	–	M xDrive
Standard transmission	–	M Steptronic
Driving performance		
Top speed	km/h	250 ⁵
Top speed with optional M Driver's Package ⁶	km/h	285 ⁵
Acceleration 0–100 km/h	s	3.8
Consumption and emissions		
Exhaust emissions standard (type-certified)	–	EU6d
WLTP ^{2, 3, 4}	–	
► Combined	l/100 km	11.0–10.6
► Combined CO ₂ emissions	g/km	250–241
Wheels/tyres		
Standard wheels	–	Front: 255/40 Z R21 Rear: 265/40 Z R21

The figures for driving performance, fuel consumption and CO₂ emissions refer to vehicles with standard transmission.

¹ The EC unladen weight refers to a vehicle with standard equipment and does not include any optional extras. The unladen weight includes a 90 % full tank and a driver weight of 75 kg. Optional equipment may affect the weight of the vehicle, the payload and the top speed if the selected equipment has an impact on the vehicle's aerodynamics.

² Performance data of petrol engines apply to vehicles using RON 98 fuel. Fuel consumption data apply to vehicles using reference fuels in accordance with EU Regulation 715/2007. Unleaded RON 91 and higher with a maximum ethanol content of 10% (E10) may also be used. BMW recommends RON 95 super unleaded petrol.

³ Official data for fuel consumption and CO₂ emissions were determined in accordance with the prescribed measurement procedure and correspond to European Regulation (EC) 715/2007 in the applicable version. In the event of ranges, data determined as per WLTP takes into account any optional equipment (available on the German market in this case). For vehicles that have been newly type approved since 1 January 2021, only the official data according to WLTP exist. For more information about NEDC and WLTP measuring procedures visit www.bmw.com/wltp

⁴ From 1 September 2017, certain new vehicles are tested according to the Worldwide Harmonised Light Vehicles Test Procedure (WLTP) before type approval is granted – WLTP provides a new, more realistic way of measuring fuel consumption, and CO₂ emissions. As of 1 September 2018, WLTP will replace the New European Driving Cycle (NEDC), the current test procedure. Based on the more realistic test conditions, in many cases the fuel consumption and CO₂ emission values measured according to the WLTP are higher than if they had been measured according to the NEDC.

⁵ Electronically limited.

⁶ The raised top speed is only available after the first service following the 2,000 km run-in period.

TECHNICAL VALUES. BMW M AUTOMOBILES.

BMW X3 M.

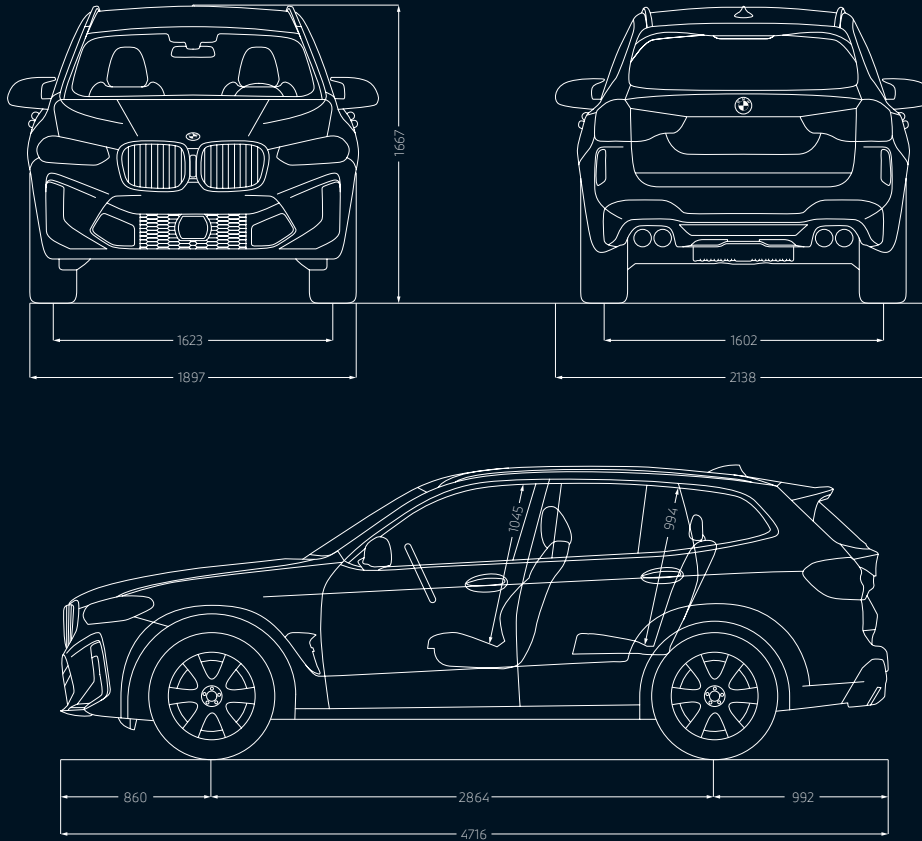

BMW X3 M COMPETITION.

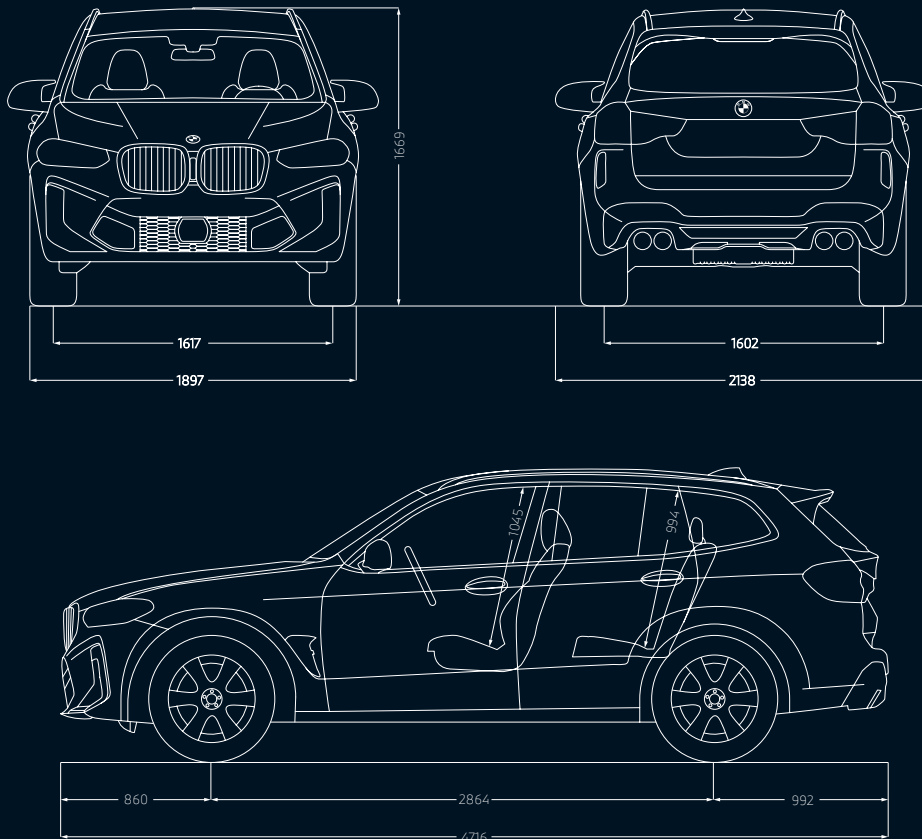



BMW SERVICE.



Always there for you: Your BMW Service Partner is there for helpful, expert support for everything to do with your BMW. Our aim is to make every journey in your BMW as pleasant as possible. A major worldwide network of workshops offers premium service from BMW specialists, innovative diagnostic technologies, and rapid availability of precisely fitting original BMW parts as well as original BMW engine oil. There are many great reasons to choose services from BMW, but there's one that really stands out: that driving pleasure that sets your BMW apart from the crowd will be yours to enjoy for many years to come with BMW Service.

WHEREVER, WHENEVER: OUR COMPREHENSIVE SERVICE.

Many BMW services can be easily booked and tracked online – so you can use your time for the really important things in life. Stay independent and flexible with online appointments and remote services. Take advantage of our innovative digital products and services such as online video advice, and get all the relevant information on your smartphone. And if you don't want to stop but have no choice, our BMW Breakdown and Accident Assistance service will help.



NOTES.

Or doodles.

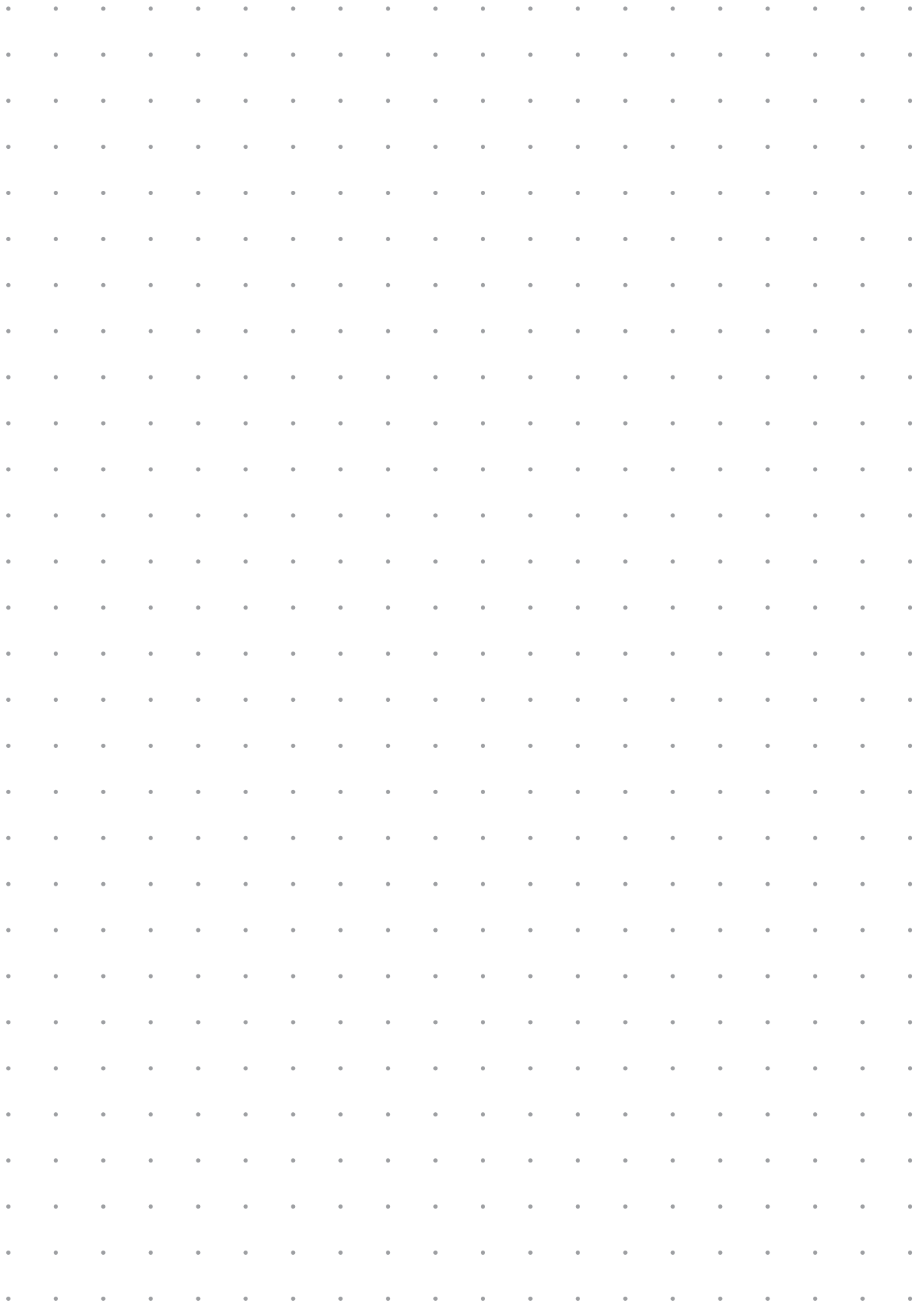

YOUR WORLD. MY BMW.



This feature is only available in conjunction with ConnectedDrive Services and a compatible smartphone. The availability and functions of the My BMW App depend on the vehicle model and may vary depending on the market.



The direct connection to your vehicle and the world of BMW: Conveniently check the vehicle status with the new My BMW App, access functions remotely, make a service appointment, plan trips and much more – this way, the app becomes your daily mobility companion.

Try it out for yourself and install the My BMW App from your Google play or App Store.

