

THE X4







Highlights

- Exterior and interior design
- Driving dynamics
- Connectivity
- Assistance systems
- X4 xDrive30i
- X4 M Competition

Model Overview

Models

- Base
- M Sport package
- M40i and M40d
- X4 M
- X4 M Competition

Equipment

Exterior Colours

Interior Colours

Wheels and Tyres

**Original BMW Accessories
and BMW M Performance
Parts**

Technical values

BMW Services

BMW X4 M40i:

Z1" M light alloy wheels Double-spoke style 718 M Bicolour with mixed tyres and run-flat tyres, exterior colour in M Brooklyn Grey metallic, sports seats in 'Vernasca' leather in Tacora Red with decorative stitching, Aluminium Rhombicle Dark BMW M interior trim with Pearl Chrome finisher.

Alterations in standard and optional equipment and the configurations available for the different models, as described in this brochure, may occur. Your local BMW Partner is available to provide further details. Subject to change in design and equipment.

ATHLETICISM IS...
POWER. MANOEUVRABILITY.
ENDURANCE. BUT ABOVE ALL,
IT'S THE MINDSET OF LEAVING
YOUR OWN LIMITS BEHIND YOU.
TAKING NEW PATHS. SEEKING,
FINDING AND REINVENTING
YOURSELF TIME AND TIME
AGAIN. IT'S THE SPIRIT OF
DISCOVERY THAT DETERMINES
ITS OWN DIRECTION.

ATHLETICISM IS
THE BMW X4.

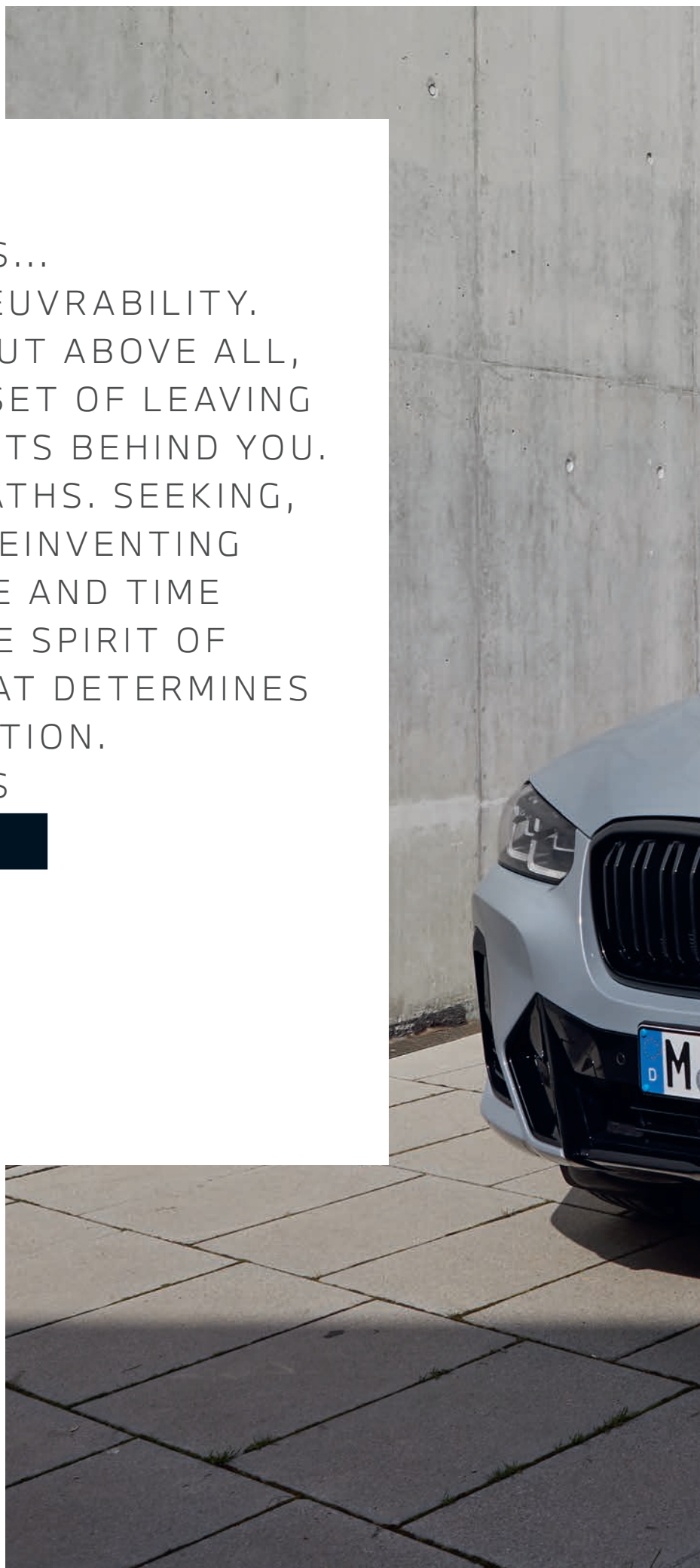





AT THE VERY FIRST GLANCE: A TRUE ATHLETE.

Even the design of the BMW X4 feels like a starting signal: Its characteristic proportions and striking lines make it appear thrillingly dynamic from every perspective. The BMW X4 enjoys pole position in every discipline.



MODERNLY EXPRESSIVE: THE FRONT.

Powerfully focused, the BMW X4 looks straight ahead. Sculptural, taut surfaces in the car's main colour span around the central, large BMW double kidney grille. The front apron with its three-part air intakes reinterprets the characteristic BMW front – an exciting sign of expressive modernity that extends to every design detail. Presence and driving pleasure that can be seen at first glance – those are the hallmarks of the BMW X4.



■ Self-consciously dynamic: The large **BMW double kidney grille** is framed by a single-piece frame that makes it appear even more present. Double crosspieces in high-gloss Black¹ intensify its striking shape, in which the M badge¹ forms an exciting highlight.

■ Standard equipment □ Optional equipment

¹ Only available for M40i and M40d.
The availability of some equipment, functions, and digital services depends on engine variants or additional optional equipment.

The offer structure as well as market and production availability may vary. For detailed information on availability, terms and costs, please contact your local BMW partner.

BETWEEN VIBRANCY AND PRESENCE: THE SIDEVIEW.

Precise lines and expressive surfaces form a powerful vehicle body with a balance between sportiness and solidity. The characteristic BMW proportions of a stretched bonnet, flat windscreen and long wheelbase are emphasised by details such as the dynamic Hofmeister kink. One particularly elegant feature is the roofline that emphasises the athletic appearance of the BMW X4 with its almost classic coupé shape.





FOCUSED ASSERTIVENESS: THE REAR.

The rear of the BMW X4 is clearly road-oriented. Sporty, low and wide, large painted surfaces create a tidy, concentrated appearance. Striking tailpipe trims continue the consistently horizontal lines and provide a powerful finish at the bottom of the BMW X4.

■ Standard equipment □ Optional equipment

The availability of some equipment, functions, and digital services depends on engine variants or additional optional equipment. The offer structure as well as market and production availability may vary.

For detailed information on availability, terms and costs, please contact your local BMW partner.



ROOM FOR PERFORMANCE: THE INTERIOR.

Sporty and contemporary elegance with extensive decorative elements, clearly structured control islands and maximum-comfort seats: every facet of the BMW X4 interior is in peak condition. Consistent driver orientation and intuitive usability of all functional elements complete an interior experience with the core message that in the BMW X4, you are the absolute centre of focus on every journey.



□ The central control element blends harmoniously into the **centre console**. The **air conditioning unit** is also integrated here, allowing intuitive access. The high-resolution, **12.3" information display** attracts attention above the centre console and measures 10.25" as standard. In the BMW X4, everything is in its place and every piece of information is immediately in view.



□ This is what absolute comfort feels like: The **sport seats** in the BMW X4 provide excellent support and are upholstered in 'Vernasca' Tacora Red leather with decorative stitching. The soft leather combines a pleasant feel with a premium look.

■ Standard equipment □ Optional equipment

The availability of some equipment, functions, and digital services depends on engine variants or additional optional equipment. The offer structure as well as market and production availability may vary.

For detailed information on availability, terms and costs, please contact your local BMW partner.

THE JOY OF DRIVING, MULTIPLIED.

Dynamically whipped into shape and thanks to the unique interaction of BMW TwinPower Turbo engines and BMW xDrive, the BMW X4 sets new standards when it comes to sporty handling. Precise and reliable steering, whatever the surface – and agility on every bend thanks to the M Sport suspension and Performance Control: With the BMW X4, new destinations are opened up every day.





□ From excitingly sporty to pleasantly comfortable: the driving experience switch enables to ideally adjust the taut **Adaptive M suspension**¹ to your preferred driving experience.

■ Optimum road grip for a clearly noticeable torque: The **M Sport differential**¹ in the BMW X4 reduces slip and enables dynamic acceleration even out of curves, whatever the weather or road surface.

■ Standard equipment □ Optional equipment

¹ Only available for M40i and M40d.
The availability of some equipment, functions, and digital services depends on engine variants or additional optional equipment.

The offer structure as well as market and production availability may vary. For detailed information on availability, terms and costs, please contact your local BMW partner.



■ **Performance Control** distributes the drive system's power to the rear wheels as needed. You will feel the result immediately: maximum agility, especially in bends, and euphoric driving dynamics from the very first moment.

■ The specific spring and damper tuning and a particularly direct suspension design in the **M Sport suspension** further intensify the already distinctly sporty handling of the BMW X4.

■ Even sportier with maximum suitability for everyday use: **Variable Sport steering** can be ideally adapted to the respective situation using the driving experience switch, facilitating both sporty and direct steering, as well as parking and turning.

■ Traction, directional stability and driving safety with maximum agility and characteristic BMW dynamics at the same time: The intelligent **xDrive** all-wheel drive brings together features that ensure you enjoy your time behind the wheel – no matter what the road surface.



■ Standard equipment □ Optional equipment

The availability of some equipment, functions, and digital services depends on engine variants or additional optional equipment. The offer structure as well as market and production availability may vary.

For detailed information on availability, terms and costs, please contact your local BMW partner.

THE CENTER OF YOUR DIGITAL WORLD.

Leave everything behind, but stay connected to everything that matters to you: in the BMW X4, comprehensive connectivity and infotainment features will ensure that you're at the heart of the action on every journey – no matter where your journey takes you.



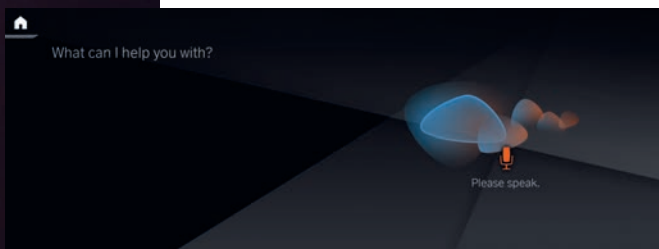

□ With the **BMW Intelligent Personal Assistant** at your side, you are perfectly prepared for every challenge: It knows plenty about your BMW X4, conveniently controls selected functions, and can be intuitively operated using its enhanced voice function.

On the road, but always connected: the **My BMW App**¹ connects you to your BMW X4, wherever you are. It not only provides you with an overview of your vehicle, but also supports you with numerous innovative functions as a personal mobility assistant to help you face every challenge in day-to-day life.

■ Standard equipment □ Optional equipment

¹ This feature is only available in conjunction with ConnectedDrive Services and a compatible smartphone. The range of functions depends on the apps installed on the smartphone.

The availability of some equipment, functions, and digital services depends on engine variants or additional optional equipment. The offer structure as well as market and production availability may vary. For detailed information on availability, terms and costs, please contact your local BMW partner.



SAFE. ALWAYS.

The BMW X4 is always at your side, providing reliable support even in challenging driving situations. A smart combination of sensors, assistance systems and safety technologies ensures that you feel perfectly at ease on every journey and can skilfully master any situation.

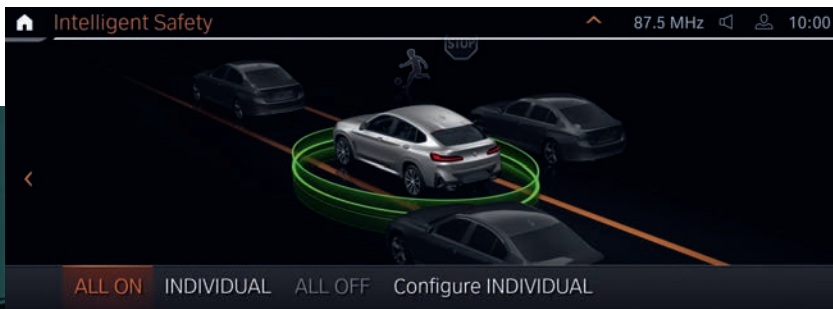

□ The **Driving Assistant Professional**¹ makes every journey even more comfortable and safe, as it is always at your side: Its active hazard warning systems, passive safety systems and innovative functions for assisted driving come together to give you that fantastic feeling of always having everything under control, so you can relax and enjoy the road.

□ Because you never know what will happen, it's good to be prepared for everything. The Driving Assistant Professional's **Emergency Stop Assistant** can automatically take control in an emergency, and bring the BMW X4 to a stop in a safe position.

□ As part of the Driving Assistant Professional, when activated **active speed control with traffic light recognition** automatically regulates speed and distance to other vehicles when travelling at up to 210 km/h, as well as making denser traffic a relaxed experience with its the Stop&Go function.

■ Standard equipment □ Optional equipment

¹ Function may be limited in darkness, fog or bright glare. The availability of some equipment, functions, and digital services depends on engine variants or additional optional equipment. The offer structure as well as market and

production availability may vary. For detailed information on availability, terms and costs, please contact your local BMW partner.

SPORTINESS,
THAT ACCELERATES YOUR PULSE.

THE BMW X4 xDRIVE30i.





THE X4 M COMPETITION

TOUCH
THAT CHILLS.





MODEL VARIANTS AT A GLANCE.

BASE

Ready for any challenge: The BMW X4 displays an intoxicating combination of powerful forward drive and fascinating design – for a dynamic driving experience from the first metre travelled.



M SPORT PACKAGE



The M stands for More: With the M Sport package, the BMW X4 takes a commanding lead. This is achieved by features such as M-specific displays and pedals, door sill finishers with M designation, tailpipe trims in high-gloss chrome, and more.

BMW M AUTOMOBILES

M40i AND M40d



Performance you can see and feel: With exciting exterior features and the most powerful engine available in the production model, the BMW X4 M40i and BMW X4 M40d are synonymous with absolute dynamism.

X4 M



X meets M – and creates absolute top performance. The BMW X4 M picks up the sportiness of the BMW X4 and takes it to a completely new level in all respects.

X4 M COMPETITION



Absolute top performance, enhanced once again: With its specifically tuned adaptive M suspension, M Sport exhaust system and 21" M light alloy wheels, the BMW X4 M Competition creates that absolute racing feeling.

BASE.

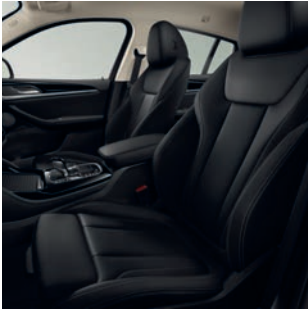

■ The adjustable sport seats for the driver and front passenger feature numerous manual adjustment options, including fore-and-aft position and backrest angle. Thanks to larger seat and backrest bolsters, and well-defined side bolsters, they provide excellent ergonomics and a high degree of lateral support.

■ The black Sport leather steering wheel with three spokes features a Chrome decorative trim. A thick rim and contoured thumb rests provide an exceptionally pleasant, high-grip feel.



■ 18" light alloy wheels V-spoke style 618 in Reflex Silver, wheel size 7J x 18, with 225/60 R18 tyres.

□ 20" light alloy wheels Y-spoke style 695 Bicolour Orbit Grey with mixed tyres, gloss-lathed, front 8J x 20 with 245/45 R20 tyres, rear 9.5J x 20 with 275/40 R20 tyres.

SELECTED BASE MODEL EXTERIOR EQUIPMENT FEATURES:

- 18" light alloy wheels V-spoke style 618
- Adaptive LED headlights
- M Sport suspension
- Variable sport steering
- Performance Control

SELECTED BASE MODEL INTERIOR EQUIPMENT FEATURES:

- Sport seats for driver and front passenger
- Sensatec perforated
- Interior trim finishers Black high-gloss with highlight trim finisher Pearl Chrome
- Sport leather steering wheel
- Steptronic transmission with gearshift paddles
- Automatic air conditioning
- BMW Live Cockpit Plus
- Interior and exterior mirror package
- Stereo speaker system

The availability of some equipment, functions, and digital services depends on engine variants or additional optional equipment. The offer structure as well as market and production availability may vary. For detailed information on availability, terms and costs, please contact your local BMW partner.

■ Standard equipment □ Optional equipment

M SPORT PACKAGE.

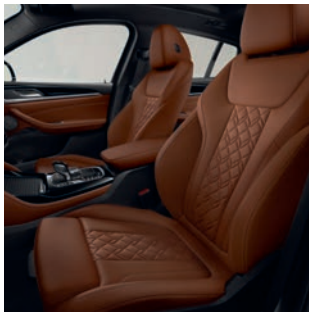

■ The adjustable sport seats for the driver and front passenger feature numerous manual adjustment options, including fore-and-aft position and backrest angle. Thanks to larger seat and backrest bolsters, and well-defined side bolsters, they provide excellent ergonomics and a high degree of lateral support.

■ The M Leather steering wheel including multifunction buttons, an M badge and an integrated driver-side airbag is featured in three-spoke design. With a steering wheel rim in leather 'Walknappa' Black with black stitching and contoured thumb rests, it provides a direct, athletic steering experience.



□ 20" M light alloy wheels Double-spoke style 699 M in Bicolour Orbit Grey with mixed tyres and run-flat tyres, gloss-lathed, wheel size front 8J x 20 with 245/45 R20 tyres, wheel size rear 9.5J x 20 with 275/40 R20 tyres.

□ 20" M light alloy wheels Double-spoke style 699 M Jet Black uni with mixed tyres, front 8J x 20 with 245/45 R20 tyres, rear 9.5J x 20 with 275/40 R20 tyres.

M SPORT PACKAGE EXTERIOR EQUIPMENT:

- M Aerodynamics package with front apron, side sills and wheel arch trims in body colour
- 19" M light alloy wheels Y-spoke style 887 M Bicolour Black Grey; other wheels available
- M Sport suspension, optionally Adaptive suspension
- M roof rails high-gloss Shadowline, alternatively roof rails Aluminium satin-finish
- M High-gloss Shadowline, alternatively BMW Individual Exterior Line Satin Aluminium
- M designation on the sides
- Exterior mirror caps in body colour
- Optional M sports brake in Blue metallic, alternatively Red high-gloss
- Rear apron with diffuser insert in Black high-gloss
- Tailpipe trim strip in Chrome high-gloss in M Sport package specific design
- Exclusive paintwork in M Brooklyn Grey metallic, alternatively M Carbon Black metallic; other paintwork available

M SPORT PACKAGE INTERIOR EQUIPMENT:

- M entry sills, M driver's footrest and M specific pedals
- Sport seats for driver and front passenger, optional M Sport seats
- Optionally exclusive Black 'Vernasca' leather with red contrast stitching including instrument panel in Sensatec with red stitching
- M leather steering wheel with multifunction buttons
- Vehicle key with exclusive M designation
- M anthracite headliner
- M interior trim finishers in Aluminium Rhombicle Dark with highlight trim finishers in Pearl Chrome; other trims available
- Loading sill of the luggage compartment in stainless steel

The availability of some equipment, functions, and digital services depends on engine variants or additional optional equipment. The offer structure as well as market and production availability may vary. For detailed information on availability, terms and costs, please contact your local BMW partner.

■ Standard equipment □ Optional equipment

M40i AND M40d.

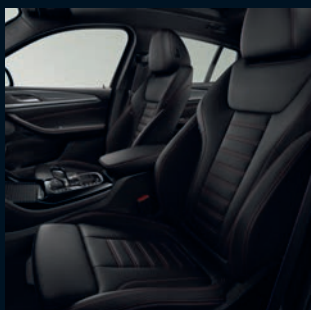

■ The adjustable sport seats for the driver and front passenger feature numerous manual adjustment options, including fore-and-aft position and backrest angle. Thanks to larger seat and backrest bolsters, and well-defined side bolsters, they provide excellent ergonomics and a high degree of lateral support.

■ The M leather steering wheel including multifunction buttons, an M badge and an integrated driver-side airbag is featured in three-spoke design. With Black 'Walknappa' leather steering wheel rim with M stitching, contoured thumb rests and an aperture at the 6 o'clock spoke it demonstrates a sporty, direct steering sensation.



■ 20" M light alloy wheels Double-spoke style 699 M in Bicolour Orbit Grey with mixed tyres and run-flat tyres, gloss-lathed, wheel size front 8J x 20 with 245/45 R20 tyres, wheel size rear 9.5J x 20 with 275/40 R20 tyres.

□ 21" BMW Individual light alloy wheels V-spoke style 726 | Bicolour, Orbit Grey with mixed tyres and run flat tyres, gloss-lathed, wheel size front 8.5J x 21 with 245/40 R21 tyres, wheel size rear 9.5J x 21 with 275/35 R21 tyres.

EXTERIOR EQUIPMENT RANGES OF THE M40i/M40d:

- Adaptive LED headlights
- 20" M light alloy wheels double-spoke 699 M with mixed tyres and run-flat properties
- M Sport suspension
- M Sport brakes
- M high-gloss Shadow Line
- M Sport differential

INTERIOR EQUIPMENT RANGES OF THE M40i/M40d:

- Sport seats for driver and front passenger
- Sensatec perforated
- M interior trim finishers in Aluminium Rhombicle dark with highlight trim finisher in Pearl Chrome
- M Leather steering wheel
- Steptronic Sport transmission
- M Anthracite headliner
- Instrument panel in Sensatec
- BMW Live Cockpit Plus
- HiFi loudspeaker system

The availability of some equipment, functions, and digital services depends on engine variants or additional optional equipment. The offer structure as well as market and production availability may vary. For detailed information on availability, terms and costs, please contact your local BMW partner.

■ Standard equipment

□ Optional equipment

X4 M.



□ The multi-adjustable M Sport seats with bucket seat character and partly integrated headrest provide excellent lateral support for you and your front passenger. In addition, the backrest width can be individually adjusted. Their special design with illuminated M logo highlights the vehicle's athletic capabilities.



■ The M leather steering wheel with shift paddles provides a direct, athletic steering experience. The red M1/M2 buttons call up preset M Drive configurations.



□ 21" M light alloy wheels V-spoke style 765 M Bicolour Jet Black with mixed tyres, gloss-lathed, front wheel size 9.5J x 21, 255/40 ZR21 tyres, rear wheel size 10J x 21, 265/40 ZR21 tyres.

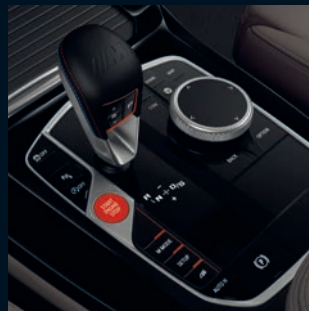

■ In the easy-to-reach centre console control panel, the M MODE button below the Start/Stop button allows you to change the contents of the display. The SETUP button offers even more choice for configuring the vehicle characteristics. It opens the menu for individual adjustments to the driving dynamics. Additional buttons switch individual assistance systems off or on.



□ The M Carbon rear spoiler emphasises the vehicle's exclusivity and powerful, sporty design and noticeably reduces unwanted aerodynamic uplift on the rear axle.

X4 M EXTERIOR EQUIPMENT RANGE:

- Adaptive LED headlights
- 20" M light-alloy wheels double-spoke 764 M Bicolour Orbit Grey with mixed tyres
- M roof rails high-gloss Shadowline
- M High-gloss Shadowline exterior trim
- M Drive
- M-specific suspension
- M Servotronic
- M Sport differential
- M Compound brakes
- Active M differential

X4 M INTERIOR EQUIPMENT RANGE:

- Sport seats for driver and front passenger
- 'Vernasca' leather
- M interior trim finishers in Aluminium Rhombicle dark with highlight trim finisher in Pearl Chrome
- M Steptronic transmission with Drivelogic
- M Anthracite headliner
- Entry sills ('X4 M')
- Harman Kardon Surround Sound System
- Ambient lighting

The availability of some equipment, functions, and digital services depends on engine variants or additional optional equipment. The offer structure as well as market and production availability may vary. For detailed information on availability, terms and costs, please contact your local BMW partner.

■ Standard equipment

□ Optional equipment

X4 M COMPETITION.



■ The M leather steering wheel with shift paddles provides a direct, athletic steering experience. The red M1/M2 buttons call up preset M Drive configurations.

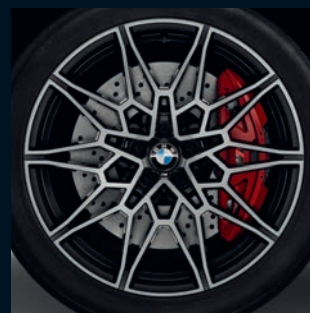
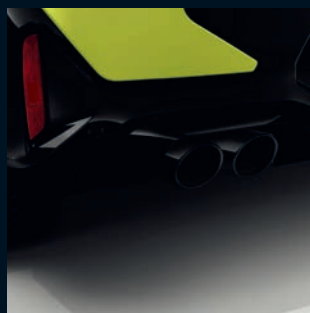
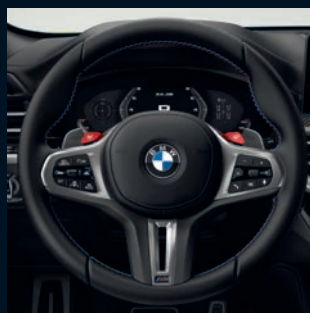

■ The multi-adjustable M Sport seats with bucket seat character and partly integrated headrest provide excellent lateral support for you and your front passenger. In addition, the backrest width can be individually adjusted. Their special design with illuminated M logo highlights the vehicle's athletic capabilities.

■ The valve-operated, M Sport exhaust system delivers either a particularly sporty or more low-key engine sound, depending on the driver's preference.

■ 21" M light alloy wheels Double-spoke style 892 M Bicolour Jet Black with mixed tyres, forged, front wheel size 9.5J x 21 with 255/40 ZR21 tyres, rear wheel size 10J x 21 with 265/40 ZR21 tyres.



□ The M lights Shadow Line include a Black finish of all chrome elements in the Adaptive LED Headlights, creating an unmistakable, sporty design.

X4 M COMPETITION EXTERIOR EQUIPMENT RANGE:

- 21" M light-alloy wheels double-spoke 892 M Bicolour Black with mixed tyres, forged
- M Sport exhaust system
- M high-gloss Shadow Line with extended features

X4 M COMPETITION INTERIOR EQUIPMENT RANGE:

- M Sport seats
- M 'Merino' leather with extended features
- M seat belts
- Entry sills ('X4 M Competition')
- Competition badge in the centre console

The availability of some equipment, functions, and digital services depends on engine variants or additional optional equipment. The offer structure as well as market and production availability may vary. For detailed information on availability, terms and costs, please contact your local BMW partner.

■ Standard equipment

□ Optional equipment

EQUIPMENT HIGHLIGHTS.



□ The M high-gloss Shadow Line with extended features includes equipment features in Black: kidney grille frame, BMW kidney grille and BMW emblem base at the rear in Black high-gloss as tailpipe trims in Black Chrome.

■ M Sport suspension is notable for a more dynamic suspension with tighter damper settings. It also features a moderately higher spring rate and harder stabilisers. Combined together, they result in an even more direct suspension design, which enables a distinctly sporty driving style.

□ The adaptive suspension makes it possible to ideally adjust the damper characteristics to suit any given driving situation, improving roll comfort and driving dynamics. In addition to the standard COMFORT setting for increased driving comfort, the SPORT program can also be selected for athletic damper settings.



□ The Comfort Access makes it possible to open all of the vehicle doors and the luggage compartment, without using the key. When approaching, the welcome greeting is activated even before the doors unlock automatically.



□ In laser high-beam mode, the Adaptive BMW Laserlight illuminates a range of up to 500 m, nearly twice as far as that of conventional headlights. Better visibility in the dark significantly increases safety. Blue accents and the lettering "BMW Laser" in the headlight also underline the technological standards and the sportiness of the vehicle.



■ The standard Adaptive LED headlights include low-beam and no-dazzle high-beam headlights (BMW Selective Beam) and turn indicators with full LED technology. The equipment also features cornering lights, daytime running lights and Adaptive headlights with variable light control for excellent illumination of the road ahead and better visibility in the dark.

■ Standard equipment □ Optional equipment

The availability of some equipment, functions, and digital services depends on engine variants or additional optional equipment. The offer structure as well as market and production availability may vary. For detailed information on availability, terms and costs, please contact your local BMW partner.

EQUIPMENT HIGHLIGHTS.



□ The Instrument panel in Sensatec lends the interior of the vehicle a highly exclusive atmosphere. The artificial leather is applied directly to a semi-rigid foam, and features an impressively soft surface. The wear-resistant material around the door panels on the front and rear features attractive double-lap seams.

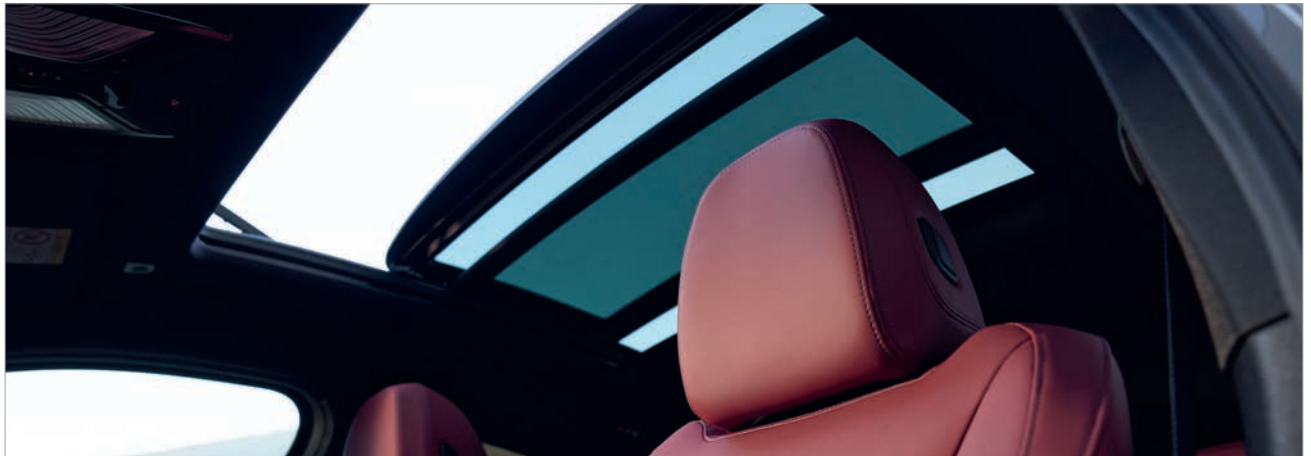

□ When open, the Panorama glass roof provides a great deal of fresh air. Closed, it creates a bright, light-flooded atmosphere in the interior. It opens and closes completely automatically at the push of a button or with the vehicle key, and is equipped with slide and lift functions, roller sunblind and wind deflector.

□ The M anthracite headliner¹ together with body pillars and grab handles also lined in anthracite ensure a sporty ambience in the interior.



□ The full-colour BMW Head-up Display² projects all information relevant to the journey directly into the driver's field of vision, thereby allowing them to fully concentrate on driving. Information such as the current speed, navigation directions, speed limit display including no-overtaking indicator, along with telephone and entertainment lists are displayed, depending on the equipment.



□ The tonally outstanding Harman Kardon surround sound system features a 464-watt digital amplifier, nine channels and 16 speakers. Its sophisticated sound perfectly fills the interior space. Vehicle-specific, speed-dependent equalising precisely compensates for any background driving noise.

■ The variable sport steering with Servotronic creates a direct and agile steering response and ensures that less physical effort is required to turn the wheel. It reacts to the angle of the steering wheel with varying steering ratios. This improves handling when driving more dynamically and reduces the effort needed to steer when parking and turning.

■ Performance Control intervenes via engine control and through controlled braking of the drive wheels towards the inside of the bend. This distributes more drive power to the outer wheels. Directing the vehicle's angular momentum into the curve to boost agility and directional stability.

■ Standard equipment □ Optional equipment

¹ Standard for M Sport package, M40i and M40d.

² The information in the BMW Head-Up Display is not fully visible when viewed through polarised sunglasses. Content shown will depend on the equipment options chosen. Further optional equipment is required to display specific items.

The availability of some equipment, functions, and digital services depends on engine variants or additional optional equipment. The offer structure as well as market and production availability may vary. For detailed information on availability, terms and costs, please contact your local BMW partner.

EQUIPMENT HIGHLIGHTS.



□ The BMW Live Cockpit Professional with navigation function includes two high-quality displays consisting of a high-resolution 12.3" Control Display that can be operated by touch and a fully digital 12.3" instrument display. The BMW Operating System 7 can also be operated via the iDrive Touch Controller⁴.



□ BMW Maps with Connected Navigation and Connected Parking, Connected Music, Smartphone Integration³ incl. Apple CarPlay and Android Auto and In-Car Experiences – the Connected Package Professional provides extensive networking capability for your BMW. You benefit from increased comfort and seamless integration of your smartphone apps.

■ The innovative operating concept of the BMW Operating System 7 enables even easier operation of vehicle functions via e.g. speech, touch screen and iDrive control – very intuitively. For this purpose, the functionality of the Controller has been upgraded. So now the apps menu can be selected directly.

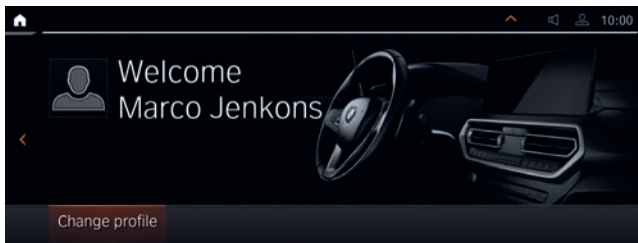

□ 'Alexa, add teabags to my shopping list.' 'Alexa, what is the weather like in Munich?' With the Amazon Alexa Car Integration^{1,2}, using the voice service in your car is effortless, just as you are used to at home. Alexa's responses are also shown as visual feedback on your vehicle's control display.

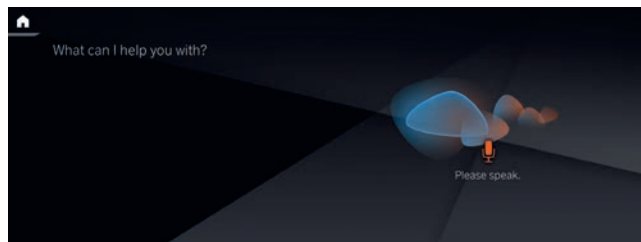
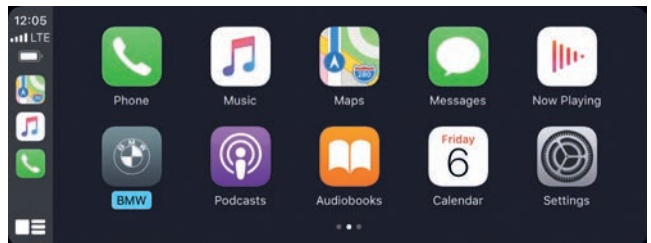

■ Why go without the features of your smartphone in your BMW when you can continue operating it as usual? Smartphone integration³ connects your smartphone wirelessly to your vehicle via Apple CarPlay and Android Auto. This allows you to conveniently use functions and various apps directly via the control display.

□ Wouldn't it be incredible if your BMW was also your personal vehicle expert? Communicate with your vehicle using the BMW Intelligent Personal Assistant. Say natural commands to operate numerous vehicle functions. It can also explain topics about your vehicle and helps you to get to know your BMW even better.

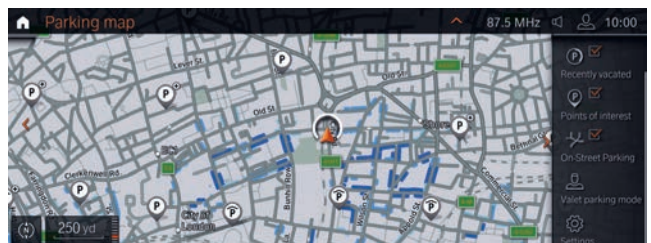

□ So that you really are at your destination: BMW Maps – Connected Parking saves you the hassle of searching for a parking space and reliably guides you to the next available parking space near your destination. Your BMW suggests vacant spaces in large parking facilities or on the street and recommends the route with the highest likelihood of an available space.

■ Standard equipment □ Optional equipment

¹ For the integration of Amazon Alexa Car Integration, an Amazon account is needed.

² Amazon, Alexa and all associated logos are trademarks of Amazon.com, Inc. or its affiliates.

³ Smartphone Integration is permanently available in the vehicle. It includes Apple CarPlay and Android Auto. Due to possible future technical developments (e.g. of mobile phones), the usability of the Apple CarPlay or Google Android Auto service cannot be guaranteed permanently. CarPlay is a trademark of Apple Inc. Android Auto is a trademark of Google LLC.

⁴ For this vehicle model, the touch functionality for the iDrive controller can currently not be offered.

The availability of some equipment, functions, and digital services depends on engine variants or additional optional equipment. The offer structure as well as market and production availability may vary. For detailed information on availability, terms and costs, please contact your local BMW partner.

EQUIPMENT HIGHLIGHTS.

□ The Driving Assistant safety package¹ includes Front Collision Warning with brake intervention, Manual Speed Limit Assist including Speed Limit Display with no-overtaking indicator and pre-warning as well as rear crossing traffic warning. Lane Departure Warning and Lane Change Warning with active return, as well as rear collision warning complete the features.

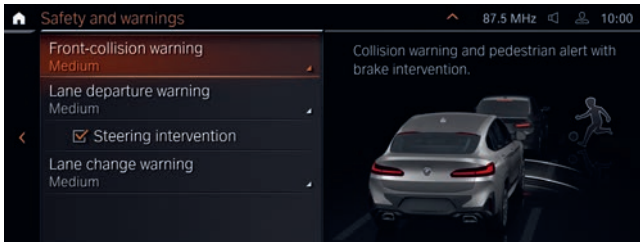

□ Driving Assistant Professional¹ offers optimum comfort and safety during critical or monotonous traffic situations. Apart from the contents of the Driving Assistant, it also includes Steering and Lane Control Assistant with extended functions, Emergency Stop Assistant and Lane Keeping Assistant with active side collision protection.

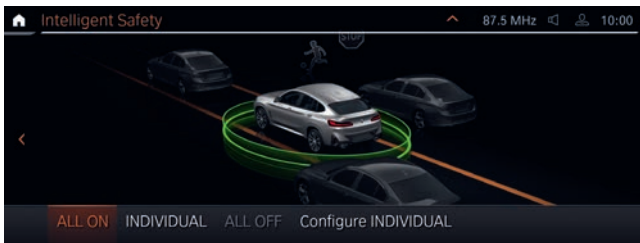

■ The Parking Assistant² makes parking the vehicle easier. The Reversing Assist Camera and Reversing Assistant support the driver when reversing. Active Park Distance Control offers increased protection against damage caused by parking. Parking Assistant parks the vehicle automatically, parallel or perpendicular to the street, and leaves parallel parking spaces.



□ The Parking Assistant Plus² makes parking and manoeuvring the vehicle easier. It features among others the Surround View system including Top View, Panorama View, Remote 3D View, as well as a lateral parking aid, the emergency braking function Active Park Distance Control, Parking Assistant with longitudinal and lateral guidance and Reversing Assistant.



□ The BMW Drive Recorder, consisting of the event and crash recorder, allows you to record a video from the vehicle environment and play the video on the Control Display or, via USB export, on your device. Important vehicle information such as speed and GPS position are stored synchronously with the video.

□ Smart, up-to-date, and sophisticated: with its contemporary design and intuitive user prompting, the My BMW App³ accompanies you through a whole new mobility experience. Plan your next trip, check the status of your BMW, book your next service appointment or use one of the numerous remote control functions – all conveniently from your smartphone.

□ The Assisted View provides real-time information on the vehicle surroundings collected by various assistance systems. Thanks to an animated 3D display in the instrument cluster, you can clearly see how your vehicle perceives the current traffic situation and thus understand how the systems work.



■ Standard equipment □ Optional equipment

¹ Function may be limited in darkness, fog or bright glare.
² The driver is responsible for constantly monitoring the automated parking procedure in accordance with local road laws.
³ This feature is only available in conjunction with ConnectedDrive Services and a compatible smartphone. The range of functions depends on the apps installed on the smartphone.

The availability of some equipment, functions, and digital services depends on engine variants or additional optional equipment. The offer structure as well as market and production availability may vary. For detailed information on availability, terms and costs, please contact your local BMW partner.

EQUIPMENT HIGHLIGHTS. PERFORMANCE.



□ The Adaptive M suspension² can be electrically adjusted at any time to suit the road and driving conditions. You can also adjust the suspension characteristics via the Driving Experience Control to enable your preferred driving style at the time – from comfortable to extremely athletic with markedly agile handling.



□ The M high-gloss Shadow Line¹ includes numerous equipment details in Black high-gloss: side frame trim strips, window recess finishers, exterior mirror caps, mirror base and triangle, B-pillar trim panels and window guide bars on the rear doors.



□ The vehicle has a high-performance M Sport braking system² that has been adapted to its dynamic potential and that ensures excellent deceleration at all times, even with a very sporty driving style. The fixed calipers exclusively finished in red with M inscription provide a striking visual feature. The front aluminium brake calipers are each equipped with four pistons, and the rear floating calipers with a single piston each. The extra-large lightweight discs feature interior ventilation and result in outstanding braking performance.

□ The vehicle has a high-performance M Sport braking system¹ that has been adapted to its dynamic potential and that ensures excellent deceleration at all times, even with a very sporty driving style. The exclusive blue painted fixed calipers with M inscription are visually striking. The front aluminium brake calipers are each equipped with four pistons, and the rear floating calipers with a single piston each. The extra-large lightweight discs feature interior ventilation and result in outstanding braking performance.

■ Standard equipment □ Optional equipment

¹ Only available for the M Sport package. Standard for M40i and M40d.

² Only available for M Sport package, M40i and M40d.

The availability of some equipment, functions, and digital services depends on engine variants or additional optional equipment. The offer structure as well as market and production availability may vary. For detailed information on availability, terms and costs, please contact your local BMW partner.

EQUIPMENT HIGHLIGHTS. PERFORMANCE.



□ The M seat belts¹ with belt tensioner and belt force limiter boast an exquisite stitched highlight in the classic M colours.



□ The multi-adjustable M Sport seats¹ with bucket seat character and partly integrated headrest provide excellent lateral support for you and your front passenger. In addition, the backrest width can be individually adjusted. Their special design with black M logo highlights the vehicle's athletic capabilities.

□ The 8-speed Steptronic Sport transmission² offers incredibly sporty gear changes. Whether automatic or manual using the selector lever or gearshift paddles – for comfortable coasting or incredibly dynamic driving. In SPORT mode and with the selector lever in the left-hand S/M position, the gear shifts are configured for the maximum performance.

■ The M sport differential³ optimises traction and driving stability when changing lanes or accelerating out of a bend, when taking bends at high speeds or on different road surfaces. Traction is optimised with the help of an electronically operated device that reduces the difference in revolution speed between the rear wheels.



■ Standard equipment □ Optional equipment

¹ Only available for M Sport package, M40i and M40d.

² Standard for M40i, M40d and xDrive30d.

³ Only available for M40i and M40d.

The availability of some equipment, functions, and digital services depends on engine variants or additional optional equipment. The offer structure as well as market and production availability may vary. For detailed information on availability, terms and costs, please contact your local BMW partner.

EXTERIOR COLOUR WORLD.



□ Non-metallic 300 Alpine White¹



■ Non-metallic 668 Black²



□ Metallic A96 Mineral White²

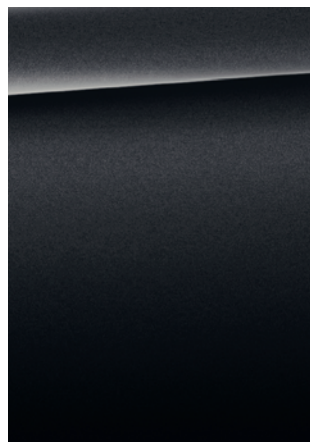

□ Metallic WA90 Sophisto Grey Brilliant Effect³



□ Metallic 475 Black Sapphire³



□ Metallic WC1M Phytonic blue³

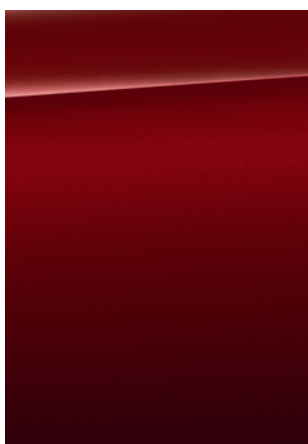

□ Metallic C57 Aventurine Red³

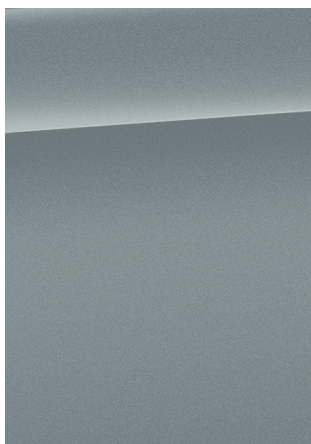

□ Metallic C4P M Brooklyn Grey⁴

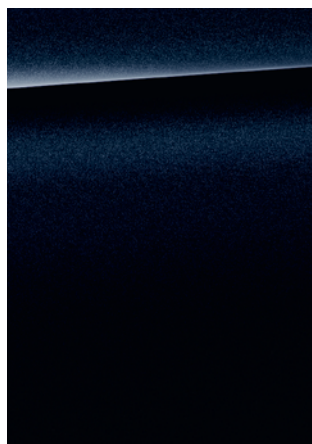

□ Metallic 416 M Carbon Black⁴

■ Standard equipment □ Optional equipment

[Colour samples] These colour samples are intended as an initial guide to the colours and materials available for your BMW. However, experience has shown that printed versions of paint, upholstery and interior trim colours cannot in all cases faithfully reproduce the appearance of the original colour. Please discuss your preferred colour choices with your BMW partner or in your dealership. There you can also see original samples and be assisted with special requests.

¹ Standard for M Sport package, M40i and M40d.

² Not available for M Sport package, M40i and M40d.

³ Also available for M Sport package, M40i and M40d.

⁴ Only available for M Sport package, M40i and M40d.

The availability of some equipment, functions, and digital services depends on engine variants or additional optional equipment. The offer structure as well as market and production availability may vary. For detailed information on availability, terms and costs, please contact your local BMW partner.

EXTERIOR COLOUR WORLD.

BMW INDIVIDUAL

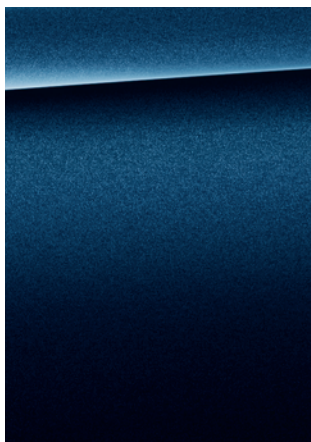

□ BMW Individual C3Z Tanzanite Blue metallic¹

BMW INDIVIDUAL SPECIAL PAINTWORK



□ BMW Individual special paintwork Frozen Brilliant White metallic

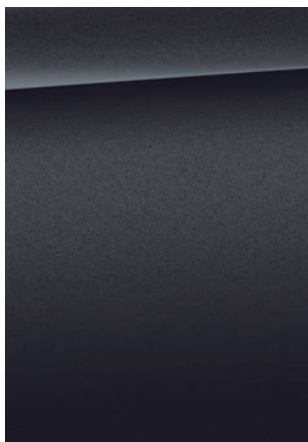

□ BMW Individual special paintwork Frozen Deep Grey metallic



□ BMW Individual special paintwork Frozen Black metallic



□ BMW Individual special paintwork Frozen Marina Bay Blue



□ BMW Individual 490 special paintwork (up to 150 paints available)



Make an individual statement. BMW Individual special paintwork offers you countless possibilities to highlight the exclusivity of your BMW X4 Series. Simply scan the QR code or ask your Authorised BMW Retailer.

■ Standard equipment □ Optional equipment

[Colour samples] These colour samples are intended as an initial guide to the colours and materials available for your BMW. However, experience has shown that printed versions of paint, upholstery and interior trim colours cannot in all cases faithfully reproduce the appearance of the original colour. Please discuss your preferred colour choices with your BMW partner or in your dealership. There you can also see original samples and be assisted with special requests.

¹ Also available for M Sport package, M40i and M40d. The availability of some equipment, functions, and digital services depends on engine variants or additional optional equipment. The offer structure as well as market and production availability may vary. For detailed information on availability, terms and costs, please contact your local BMW partner.

INTERIOR COLOURS.

UPHOLSTERY COLOURS



■ Sensatec perforated KHFY Canberra Beige



■ Sensatec perforated KHRI Cognac



■ Sensatec perforated KHG7 Tacora Red

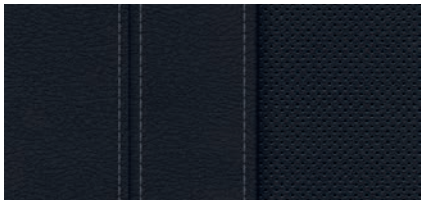

■ Sensatec perforated KHSW Black

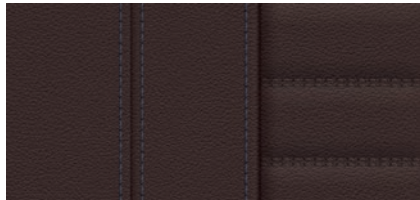

□ Leather 'Vernasca' MAMU Mocha with decorative stitching

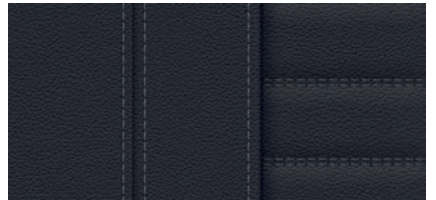

□ Leather 'Vernasca' MAH7 Black decorative stitching

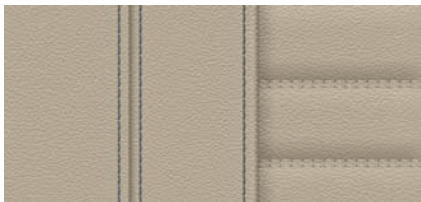

□ Leather 'Vernasca' MAOI Oyster with decorative stitching

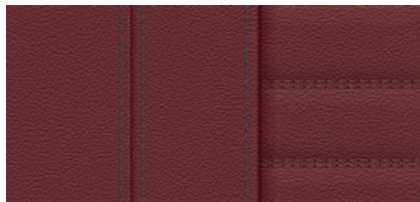

□ Leather 'Vernasca' MAG6 Tacora Red with decorative stitching

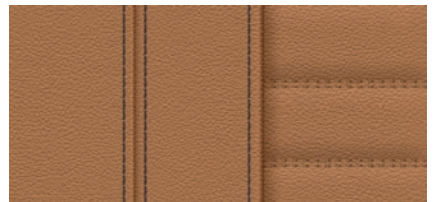

□ Leather 'Vernasca' MAPQ Cognac with decorative stitching¹

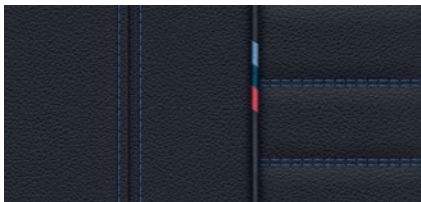

□ Leather 'Vernasca' MANL Black with Blue contrast stitching.¹

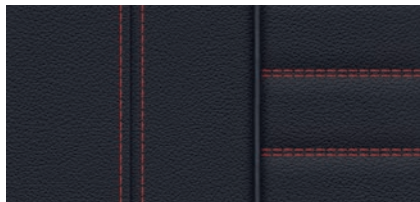

□ Leather 'Vernasca' MAH8 Black with Red contrast stitching

BMW INDIVIDUAL

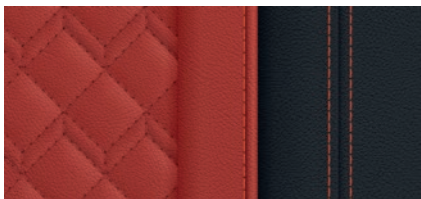

□ BMW Individual extended leather trim 'Merino' VAHZ Fiona Red/Black

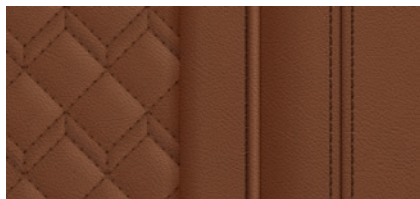

□ BMW Individual extended leather trim 'Merino' VATQ Tartufo

■ Standard equipment □ Optional equipment

¹ Only available for M Sport package, M40i and M40d.
The availability of some equipment, functions, and digital services depends on engine variants or additional optional equipment. The offer structure as well as market and production availability may vary. For detailed information on availability, terms and costs, please contact your local BMW partner.

Please note that even normal long- or short-term use can lead to unrecoverable upholstery damage. This can be caused in particular by non-colourfast clothing. Please note that the interior colour depends on the selected upholstery colour.

INTERIOR COLOURS.

INTERIOR TRIM FINISHERS



■ Interior trim finishers black high-gloss with highlight trim finisher Pearl Chrome

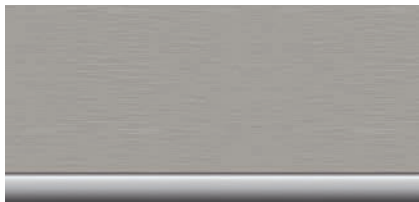

□ Interior trim finishers Aluminium fine cutting with highlight trim finisher Pearl Chrome

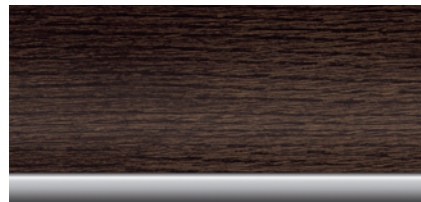

□ Fine-wood trim Oak dark high-gloss with highlight trim finisher Pearl Chrome

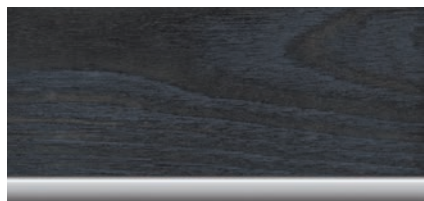

□ Fine-wood trim Ash Trunk open-pored with highlight trim finisher Pearl Chrome

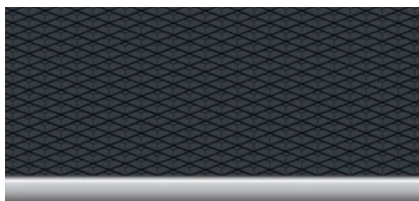

■ M interior trim finishers Aluminium Rhombicle dark with highlight trim finisher Pearl Chrome¹

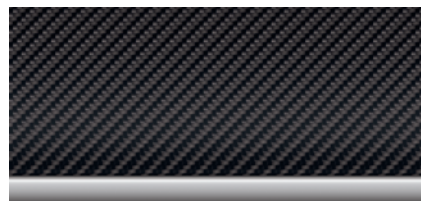

□ M interior trim finishers 'Carbon Fibre' with highlight trim finisher Pearl Chrome¹

BMW INDIVIDUAL



□ BMW Individual interior trim finishers piano finish Black

■ Standard equipment □ Optional equipment

¹ Only available for M Sport package, M40i and M40d.
The availability of some equipment, functions, and digital services depends on engine variants or additional optional equipment. The offer structure as well as market and production availability may vary. For detailed information on availability, terms and costs, please contact your local BMW partner.

Please note that even normal long- or short-term use can lead to unrecoverable upholstery damage. This can be caused in particular by non-colourfast clothing. Please note that the interior colour depends on the selected upholstery colour.

WHEELS AND TYRES.

■ 18" light alloy wheels V-spoke style 618 in Reflex Silver, wheel size 7J x 18, with 225/60 R18 tyres.¹



□ 19" light alloy wheels V-spoke style 692 Bicolour Ferric Grey, gloss-lathed, wheel size 7.5J x 19 with 245/50 R19 tyres.¹



□ 19" M light alloy wheels Double-spoke style 887 M Bicolour Black Grey, 7.5J x 19 with 245/50 R19 tyres.²



□ 20" light alloy wheels Y-spoke style 695 Bicolour Orbit Grey with mixed tyres, gloss-lathed, front 8J x 20 with 245/45 R20 tyres, rear 9.5J x 20 with 275/40 R20 tyres.¹



□ 19" light alloy wheels Y-spoke style 693, Ferric Grey, gloss-lathed, wheel size 7.5J x 19 with 245/50 R19 tyres.¹



□ 19" aerodynamic wheels 842 Bicolour Jet Black uni, gloss-lathed, wheel size 7.5J x 19 with 245/50 R19 tyres.¹



□ 20" M light alloy wheels Double-spoke style 699 M Orbit Grey with mixed tyres, gloss-lathed, front 8J x 20 with 245/45 R20 tyres, rear 9.5J x 20 with 275/40 R20 tyres.³



□ 20" M light alloy wheels Double-spoke style 699 M Jet Black uni with mixed tyres, front 8J x 20 with 245/45 R20 tyres, rear 9.5J x 20 with 275/40 R20 tyres.³



□ 20" M light alloy wheels Double-spoke style 787 M Orbit Grey with mixed tyres, gloss-lathed, front 8J x 20 with 245/45 R20 tyres, rear 9.5J x 20 with 275/40 R20 tyres.



□ 21" M light alloy wheels Double-spoke style 718 M Bicolour Jet Black with mixed tyres and run-flat tyres, gloss-lathed, wheel size front 8.5J x 21 with 245/40 R21 tyres, wheel size rear 9.5J x 21 with 275/35 R21 tyres.⁴



□ 21" BMW Individual light alloy wheels V-spoke style 726 I Bicolour, Orbit Grey with mixed tyres and run-flat tyres, gloss-lathed, wheel size front 8.5J x 21 with 245/40 R21 tyres, wheel size rear 9.5J x 21 with 275/35 R21 tyres.

■ Standard equipment □ Optional equipment

¹ Not available for M Sport package, M40i and M40d.
² Only available for the M Sport package.
³ Only available for M Sport package, M40i and M40d.
⁴ Only available for M40i and M40d.

The availability of some equipment, functions, and digital services depends on engine variants or additional optional equipment. The offer structure as well as market and production availability may vary. For detailed information on availability, terms and costs, please contact your local BMW partner.



EXTERIOR COLOUR WORLD. BMW M AUTOMOBILES.



■ Non-metallic 300 Alpine White



□ Solid paint C4H M Sao Paulo Yellow

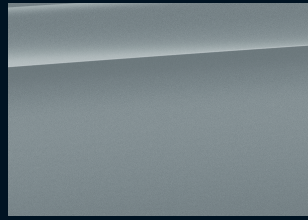

□ Metallic C4P M Brooklyn Grey



□ Metallic A90 Sophisto Grey Brilliant Effect



□ Metallic 475 Black Sapphire

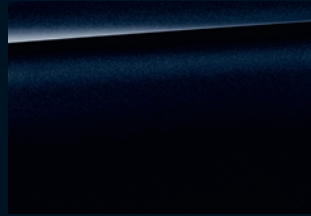

□ Metallic 416 M Carbon Black



□ Metallic C1K M Marina Bay Blue



□ Metallic C3G M Toronto Red

BMW INDIVIDUAL



□ BMW Individual special paintwork Frozen Brilliant White metallic

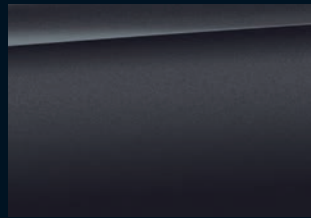

□ BMW Individual special paintwork Frozen Deep Grey metallic



□ BMW Individual special paintwork Frozen Marina Bay Blue metallic

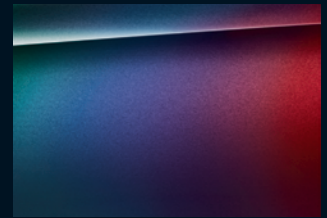

□ BMW Individual 490 special paintwork (up to 150 paints available)

WHEELS AND TYRES. BMW M AUTOMOBILES.



■ 20" M light alloy wheels Double-spoke style 764 M Bicolour Orbit Grey with mixed tyres, gloss-lathed, front wheel size 9J x 20 with 255/45 ZR20 tyres, rear wheel size 10J x 20 with 265/45 ZR20 tyres.¹



■ 21" M light alloy wheels Double-spoke style 892 M Bicolour Jet Black with mixed tyres, forged, front wheel size 9.5J x 21 with 255/40 ZR21 tyres, rear wheel size 10J x 21 with 265/40 ZR21 tyres.²



□ 21" M light alloy wheels V-spoke style 765 M Bicolour Jet Black with mixed tyres, gloss-lathed, front wheel size 9.5J x 21, 255/40 ZR21 tyres, rear wheel size 10J x 21, 265/40 ZR21 tyres.



Make an individual statement. BMW Individual special paintwork offers you countless possibilities to highlight the exclusivity of your BMW X4 Series. Simply scan the QR code or ask your Authorised BMW Retailer.

■ Standard equipment □ Optional equipment

[Colour samples] These colour samples are intended as an initial guide to the colours and materials available for your BMW. However, experience has shown that printed versions of paint, upholstery and interior trim colours cannot in all cases faithfully reproduce the appearance of the original colour. Please discuss your preferred colour choices with your BMW partner or in your dealership. There you can also see original samples and be assisted with special requests.

¹ Not available for Competition models.

² Only available for Competition models.

The availability of some equipment, functions, and digital services depends on engine variants or additional optional equipment. The offer structure as well as market and production availability may vary. For detailed information on availability, terms and costs, please contact your local BMW partner.

INTERIOR COLOURS. BMW M AUTOMOBILES.

UPHOLSTERY COLOURS

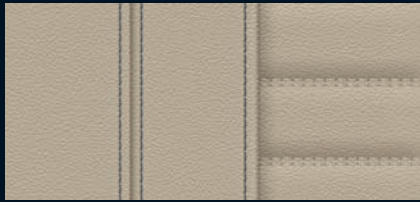

■ Leather 'Vernasca' MAOI Oyster with decorative stitching



■ Leather 'Vernasca' MAH7 Black decor stitching



□ Leather/Alcantara combination HDJA Black, with contrast stitching Midrand Beige¹

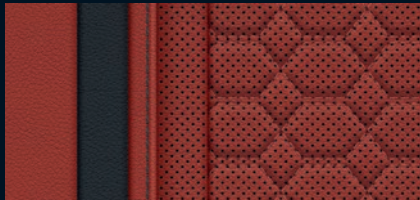

□ Leather 'Merino' LKDA with extended contents Sakhir Orange



□ Leather 'Merino' LKSW with extended contents Black²

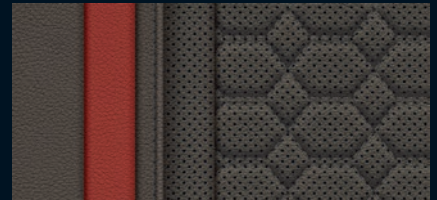

□ Leather 'Merino' LKHV with extended contents Adelaide Grey

BMW INDIVIDUAL

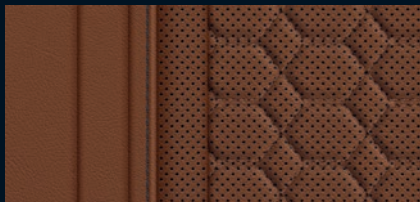

□ BMW Individual extended leather trim 'Merino' VATQ Tartufo

INTERIOR TRIM FINISHERS

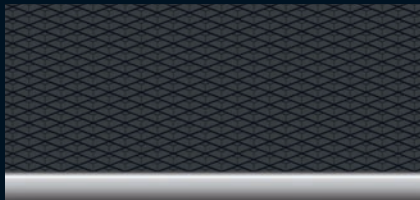

■ M interior trim finishers Aluminium Rhombicle dark with highlight trim finisher Pearl Chrome

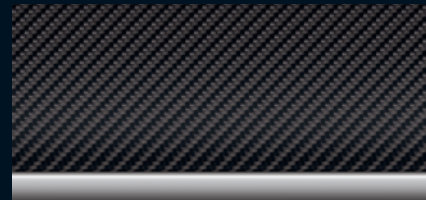

□ M interior trim finishers 'Carbon Fibre' with highlight trim finisher Pearl Chrome

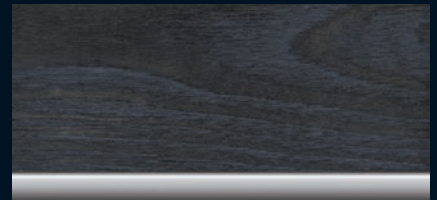

□ Fine-wood trim Ash Trunk open-pored with highlight trim finisher Pearl Chrome

BMW INDIVIDUAL

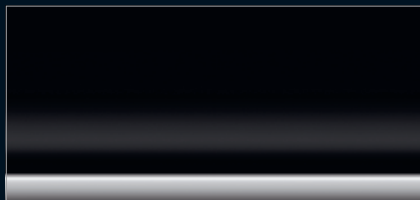

□ BMW Individual interior trim finishers piano finish Black

■ Standard equipment □ Optional equipment

¹ Only available for Competition models.

² Standard for Competition models.

The availability of some equipment, functions, and digital services depends on engine variants or additional optional equipment. The offer structure as well as market and production availability may vary. For detailed information on availability, terms and costs, please contact your local BMW partner.

Please note that even normal long- or short-term use can lead to unrecoverable upholstery damage. This can be caused in particular by non-colourfast clothing. Please note that the interior colour depends on the selected upholstery colour.



ORIGINAL BMW ACCESSORIES.

Intensive driving experiences, even further enhanced: Original BMW accessories are the best match for an original BMW. Whether wheels and tyres, transport and luggage compartment solutions, interior accessories, communication, information and technology, charging accessories or M performance parts, with original BMW accessories you'll find exactly the individual solution that will allow you to discover driving pleasure as if for the first time.



WHEELS AND TYRES.

With original BMW complete wheels, you'll reach your destination safely, and emphasise the sporty appearance of your BMW from the very first glance. But what you don't immediately realise is that they are precisely tailored to your BMW, are subject to very stringent tests with intensive material and function checks, and have been developed in close collaboration with leading tyre manufacturers – individually tuned to the driving dynamics and design language of each individual BMW model.

TRANSPORT AND LUGGAGE COMPARTMENT SOLUTIONS.

Original BMW Accessories offer you a wide range of transport and luggage compartment solutions. In line with your personal preferences and interests, you can use them to create additional space whenever and wherever you need it. Whether carrier systems or accessories for the luggage compartment, you can always rely on original BMW accessories to be precisely tailored to your BMW, and easy to use.



INTERIOR ACCESSORIES.

A perfect fit: all original BMW accessory products for the interior help to design the interior of your BMW to fully meet your personal preferences. In addition to the excellent functionality of original BMW accessories, you are also always choosing attractive BMW design alongside extraordinary craftsmanship and material quality – combined with an ambience that will excite you every time you drive.



COMMUNICATION, INFORMATION AND TECHNOLOGY.

Cutting-edge functions and features for maximum freedom and flexibility: Original BMW accessories for communication, information and technology are always at your side. Whether you value optimum availability by phone or the best sound, the innovative original BMW accessories will have the right solution for you. You'll always enjoy a good connection and custom entertainment, wherever your journey takes you.

CHARGING ACCESSORIES.

Regardless of where and how you want to charge your new BMW, original BMW charging accessories offer you tailor-made products and services. You can charge your BMW at any domestic socket using the BMW Flexible Fast Charger or, for even more convenience, at a BMW Wallbox from original BMW accessories; what's more, there's also a widespread network of public charging points available for when you're on the road. Innovative Connected Charging services show charging stations in your BMW's information display, for example, or enable you to easily start pre-conditioning your vehicle just using your smartphone.



M PERFORMANCE PARTS.

With M performance parts, you can experience BMW's motorsport DNA with fascinating intensity, even off the racetrack. A wide range of technical and visual components makes outstanding technology a visible and tangible experience. Exclusive materials and first-rate quality guarantee flawless dynamism. Experience inspiring maximum product performance: individual, expressive and uncompromising.

The availability of the equipment shown and described may vary on a market-specific basis. Your local BMW partner will be happy to advise you on the full range of original BMW accessories.

Discover the whole range of original BMW accessories and the BMW M performance parts product portfolio.



TECHNICAL VALUES.

BMW X4		xDrive20i ⁶ with mild hybrid technology	xDrive30i ⁶ with mild hybrid technology	M40i ⁶ with mild hybrid technology	xDrive20d ⁶ with mild hybrid technology	xDrive30d ⁶ with mild hybrid technology	M40d ⁶ with mild hybrid technology
Weight and volume							
Unladen weight EC ¹	kg	1875	1890	1995	1915	2010	2095
Maximum permissible weight	kg	2420	2450	2500	2450	2530	2560
Luggage capacity	l	525–1430	525–1430	525–1430	525–1430	525–1430	525–1430
Tank capacity, approx.	l	65	65	65	68	68	68
Output and torque²							
Cylinders/displacement	Number/cm ³	4/1998	4/1998	6/2998	4/1995	6/2993	6/2993
Maximum output	kW (hp)/rpm	135 (184)/ 5000–6500	180 (245)/ 5000–6500	265 (360)/ 5200–6500	140 (190)/ 4000	210 (286)/ 4000	250 (340)/ 4400
With mild hybrid technology	kW (hp)	+8 (11)	+8 (11)	+8 (11)	+8 (11)	+8 (11)	+8 (11)
Maximum torque	Nm/rpm	300/1350–4000	350/1560–4800	500/1900–5000	400/1750–2500	650/1500–2500	700/1750–2250
Power transmission							
Type of drive	–	All-wheel	All-wheel	All-wheel	All-wheel	All-wheel	All-wheel
Standard transmission	–	8-speed Steptronic	8-speed Steptronic	8-speed Steptronic	8-speed Steptronic	8-speed Steptronic	8-speed Steptronic
Performance							
Top speed	km/h	215	235	250 ⁵	213	245	250 ⁵
Acceleration 0–100 km/h	s	8.4	6.6	4.9	7.9	5.7	4.9
Consumption and emissions							
Exhaust emissions standard (type-certified)	–	EU6d	EU6d	EU6d	EU6d	EU6d	EU6d
WLTP ^{2,3,4}							
► Combined consumption, PHEV weighted	l/100 km	8.3–7.5	8.5–7.5	9.5–8.7	6.5–5.7	7.0–6.1	7.3–6.5
► Combined CO ₂ emissions	g/km	190–169	192–171	215–198	169–149	182–161	190–171
Wheels/tyres							
Standard wheels	–	225/60 R18 104 W XL	225/60 R18 104 W XL	Front: 245/45 R20 103 W XL Rear: 275/40 R20 106 W XL	225/60 R18 104 W XL	225/60 R18 104 W XL	Front: 245/45 R20 103 W XL Rear: 275/40 R20 106 W XL

The figures for performance, fuel consumption and CO₂ emissions refer to vehicles with standard transmission.

¹ The EC unladen weight refers to a vehicle with standard equipment and does not include any optional equipment. The unladen weight includes a 90% full tank and a driver weight of 75 kg. Optional equipment may affect the weight of the vehicle, the payload and the top speed if the selected equipment has an impact on the vehicle's aerodynamics.

² Performance data of petrol engines apply to vehicles using RON 98 fuel. Fuel consumption data apply to vehicles using reference fuels in accordance with EU Regulation 715/2007. Unleaded RON 91 and higher with a maximum ethanol content of 10 % (E10) may also be used. BMW recommends RON 95 super unleaded petrol.

³ Official data for fuel consumption and CO₂ emissions was determined in accordance with the prescribed measuring procedure and corresponds to European Regulation (EC) 715/2007 in the applicable version. For ranges, data determined as per WLTP takes into account any optional equipment (available on the German market in this case).

For vehicles that have been newly type approved since 1 January 2021, only the official data according to WLTP exist. For more information about WLTP and NEDC measuring procedures see www.bmw.com/wltp

⁴ From 1 September 2017, certain new vehicles have been being tested according to the World Harmonised Light Vehicle Test Procedure (WLTP) before type approval is granted – the WLTP is a new procedure that provides a more realistic way of measuring fuel consumption and CO₂ emissions. As of 1 September 2018, the WLTP replaced the New European Driving Cycle (NEDC), the previous test procedure. Due to the more realistic testing conditions, the fuel consumption and CO₂ emissions are, in many cases, higher than when measured according to the NEDC.

⁵ Electronically limited.

⁶ This engine version is not available in all countries. For further information, please contact your local BMW Partner.

TECHNICAL VALUES.

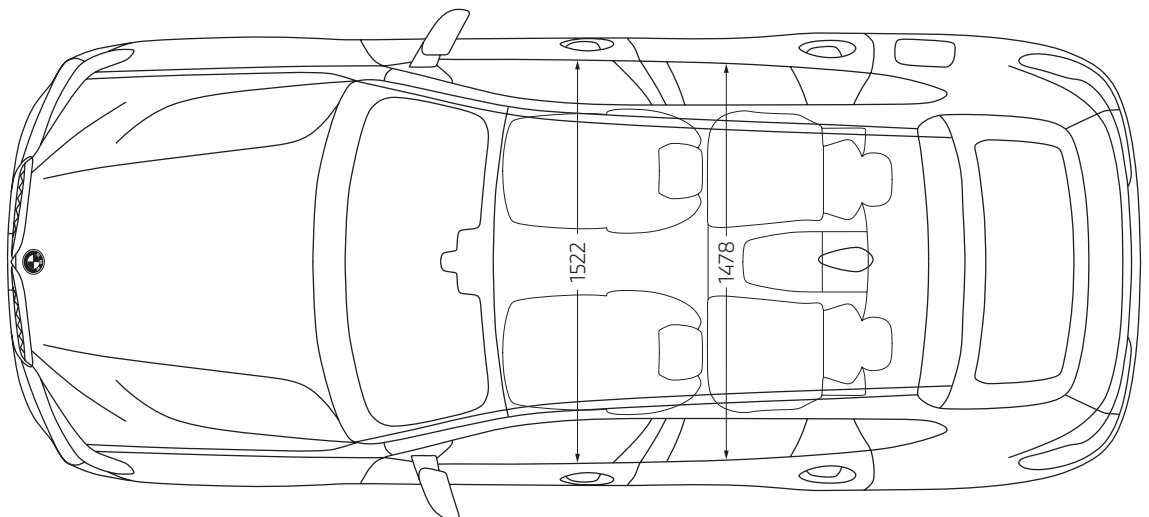
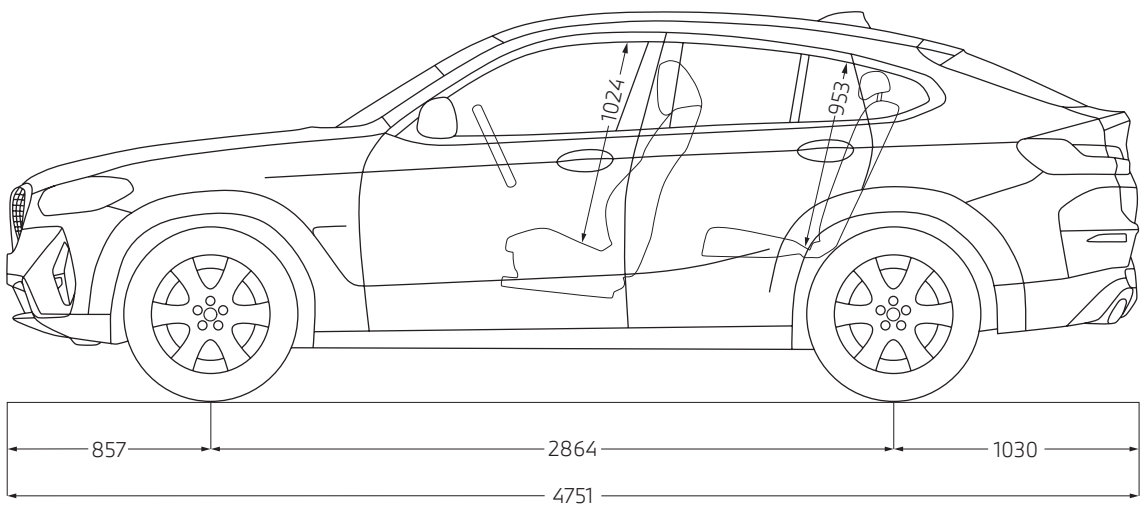
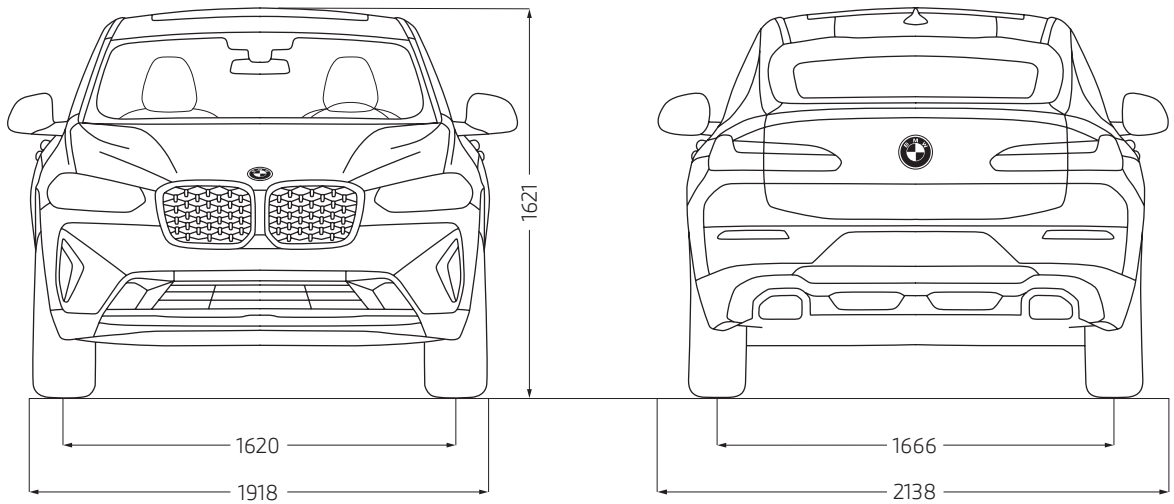

TECHNICAL VALUES. BMW M AUTOMOBILES.

BMW X4 M

X4 M Competition

Weight and volume

Unladen weight EC ¹	kg	2085
Maximum permissible weight	kg	2500
Luggage capacity	l	525–1430
Tank capacity, approx.	l	65

Output and torque²

Cylinders/displacement	Number/cm ³	6/2993
Maximum output	kW (hp)/rpm	375 (510)/6250
Maximum torque	Nm/rpm	650/2750–5500

Power transmission

Type of drive	–	M xDrive
Standard transmission	–	M Steptronic

Performance

Top speed	km/h	250 ⁵
Top speed with optional M Driver's Package ⁶	km/h	285 ⁵
Acceleration 0–100 km/h	s	3.8

Consumption and emissions

Exhaust emissions standard (type-certified)	–	EU6d
WLTP ^{2, 3, 4}		
► Combined	l/100 km	10.8–10.5
► Combined CO ₂ emissions	g/km	247–238

Wheels/tyres

Standard wheels	–	Front: 255/40 Z R21 Rear: 265/40 Z R21
-----------------	---	---

The figures for performance, fuel consumption and CO₂ emissions refer to vehicles with standard transmission.

¹ The EC unladen weight refers to a vehicle with standard equipment and does not include any optional equipment. The unladen weight includes a 90% full tank and a driver weight of 75 kg. Optional equipment may affect the weight of the vehicle, the payload and the top speed if the selected equipment has an impact on the vehicle's aerodynamics.

² Performance data of petrol engines apply to vehicles using RON 98 fuel. Fuel consumption data apply to vehicles using reference fuels in accordance with EU Regulation 715/2007. Unleaded RON 91 and higher with a maximum ethanol content of 10% (E10) may also be used. BMW recommends RON 95 super unleaded petrol.

³ Official data for fuel consumption and CO₂ emissions was determined in accordance with the prescribed measuring procedure and corresponds to European Regulation (EC) 715/2007 in the applicable version. For ranges, data determined as per WLTP takes into account any optional equipment (available on the German market in this case).

For vehicles that have been newly type approved since 1 January 2021, only the official data according to WLTP exists. For more information about NEDC and WLTP measuring procedures visit www.bmw.com/wltp

⁴ From 1 September 2017, certain new vehicles have been being tested according to the World Harmonised Light Vehicle Test Procedure (WLTP) before type approval is granted – the WLTP is a new procedure that provides a more realistic way of measuring fuel consumption and CO₂ emissions. As of 1 September 2018, the WLTP replaced the New European Driving Cycle (NEDC), the previous test procedure. Due to the more realistic testing conditions, the fuel consumption and CO₂ emissions are, in many cases, higher than when measured according to the NEDC.

⁵ Electronically limited.

⁶ The raised top speed is only available after the first service following the 2,000 km run-in period.

TECHNICAL VALUES. BMW M AUTOMOBILES.

BMW X4 M.

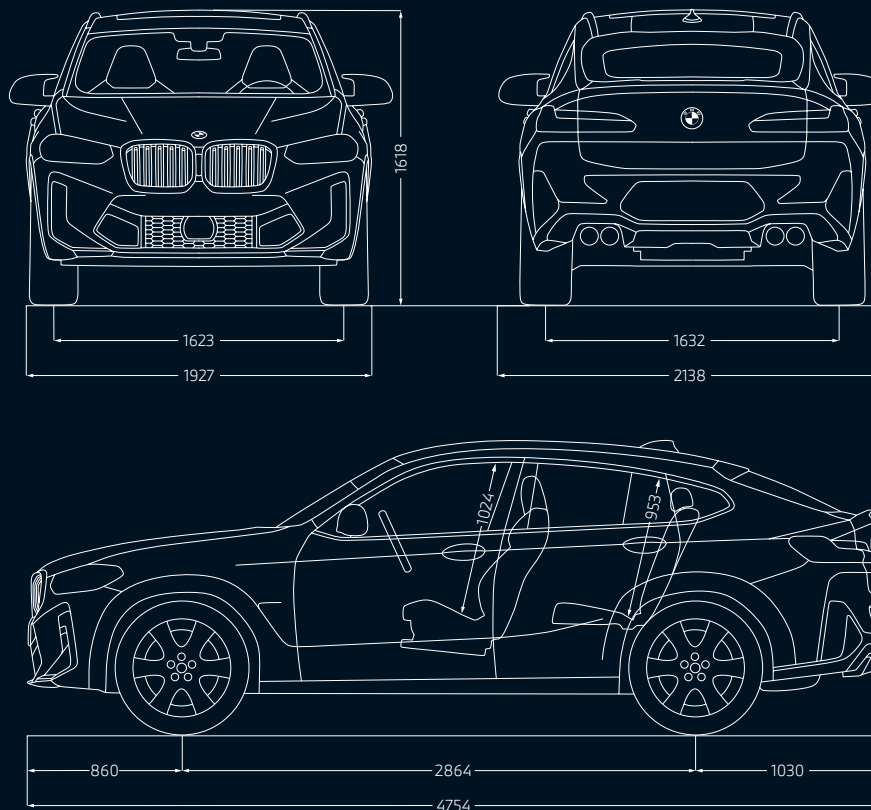

BMW X4 M COMPETITION.

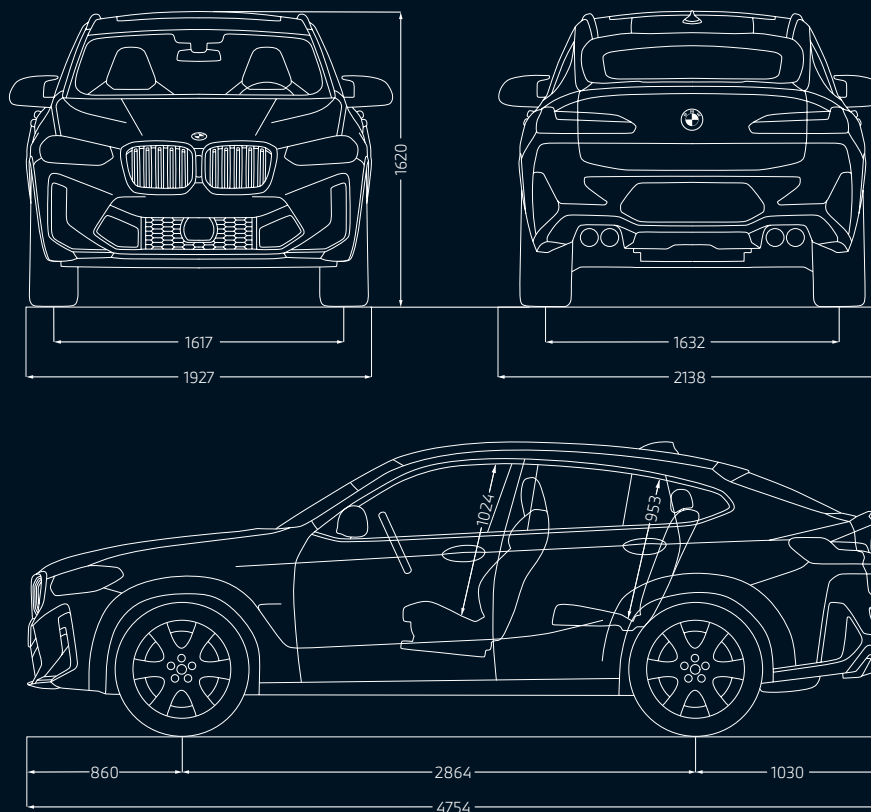



BMW SERVICE.



Always there for you: Your BMW Service Partner is there for helpful, expert support for everything to do with your BMW. Our aim is to make every journey in your BMW as pleasant as possible. A major worldwide network of workshops offers premium service from BMW specialists, innovative diagnostic technologies, and rapid availability of precisely fitting original BMW parts as well as original BMW engine oil. There are many great reasons to choose services from BMW, but there's one that really stands out: that driving pleasure that sets your BMW apart from the crowd will be yours to enjoy for many years to come with BMW Service.

WHEREVER, WHENEVER: OUR COMPREHENSIVE SERVICE.

Many BMW services can be easily booked and tracked online – so you can use your time for the really important things in life. Stay independent and flexible with online appointments and remote services. Take advantage of our innovative digital products and services such as online video advice, and get all the relevant information on your smartphone. And if you don't want to stop but have no choice, our BMW Breakdown and Accident Assistance service will help.



NOTES.

Or doodles.

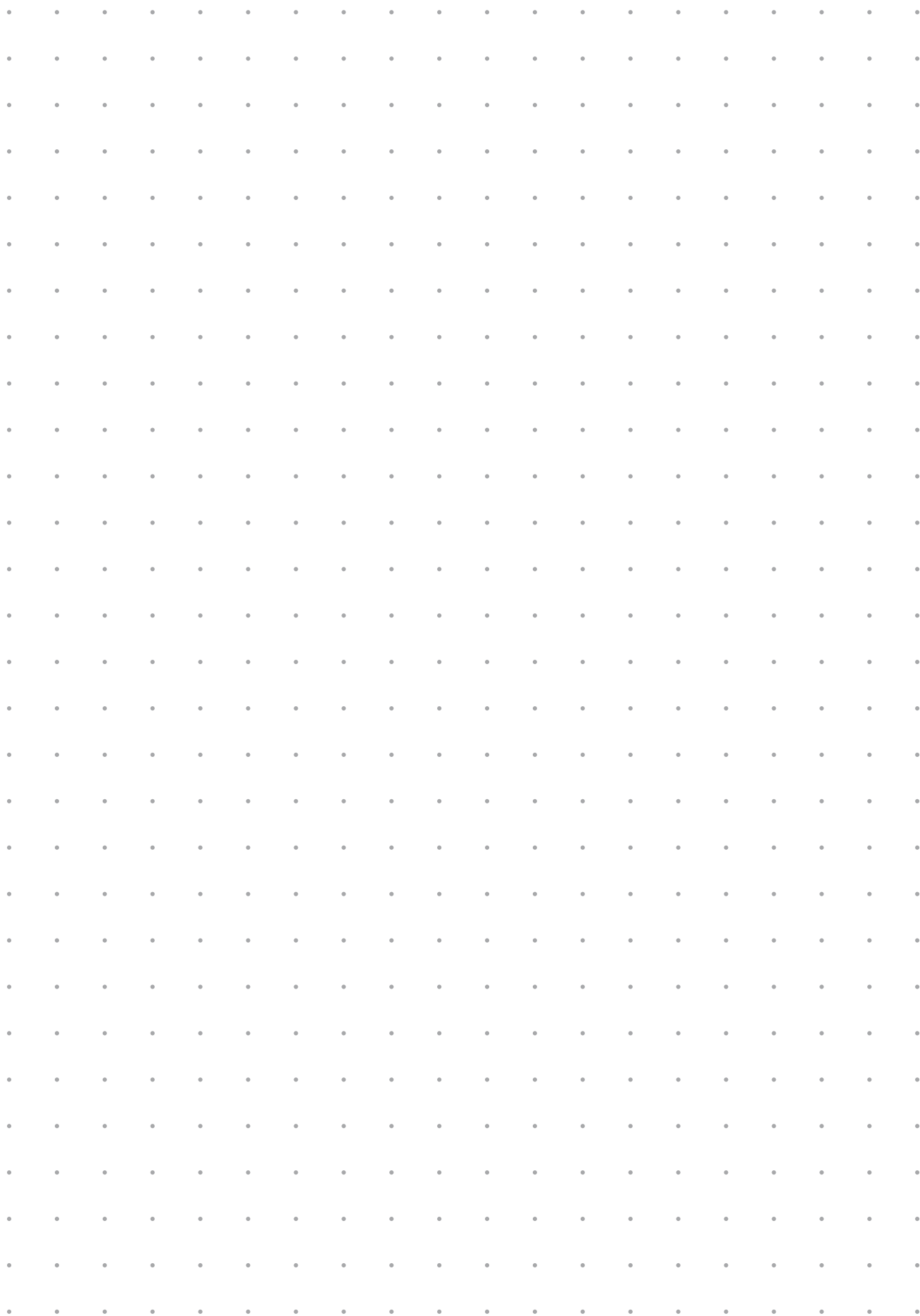

YOUR WORLD. MY BMW.



This feature is only available in conjunction with ConnectedDrive Services and a compatible smartphone. The availability and functions of the My BMW App depend on the vehicle model and may vary depending on the market.



The direct connection to your vehicle and the world of BMW: Conveniently check the vehicle status with the new My BMW App, access functions remotely, make a service appointment, plan trips and much more – this way, the app becomes your daily mobility companion.

Try it out for yourself and install the My BMW App from your Google play or App Store.

