

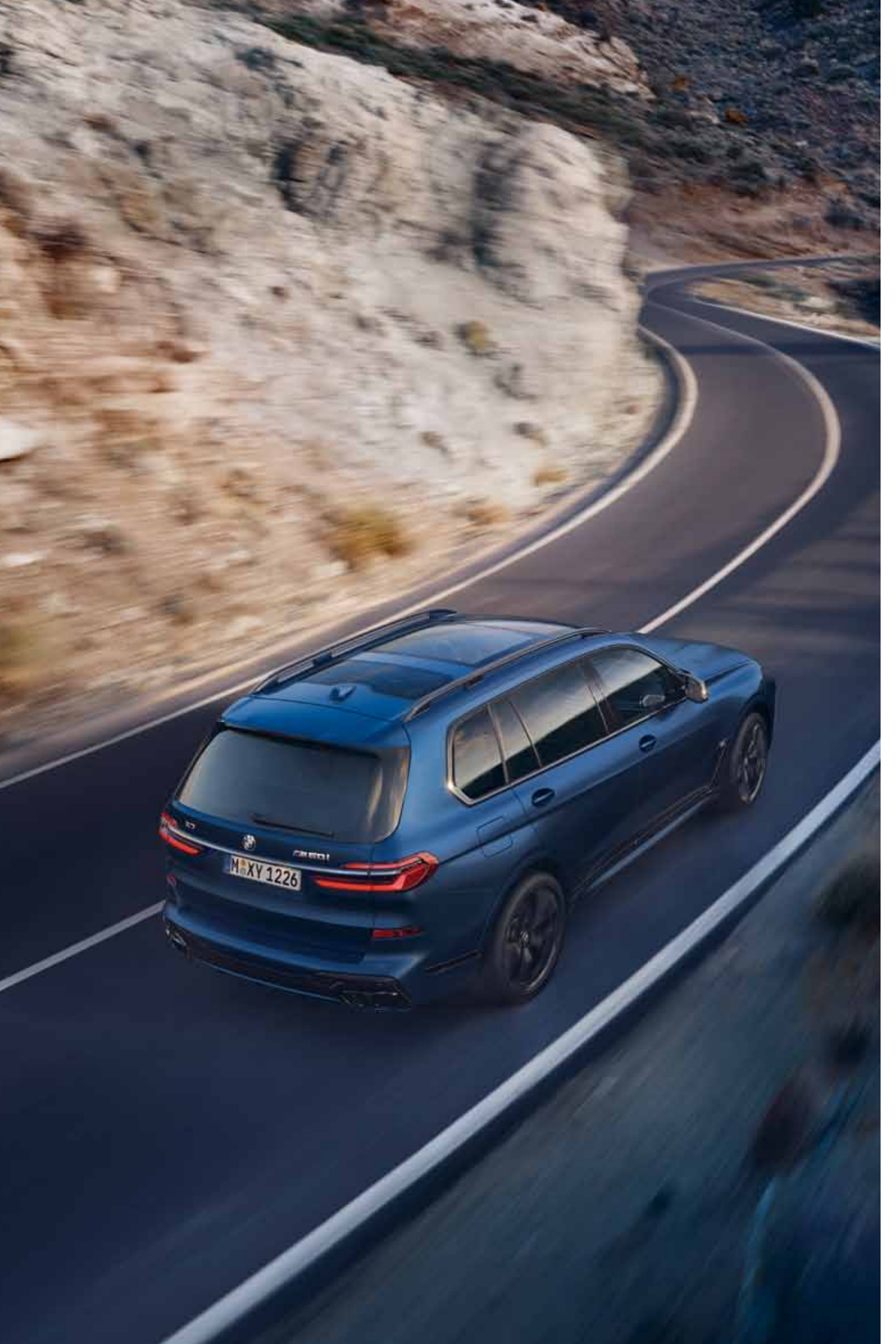

T H E

X7







### Highlights

- Exterior design and view
- Interior design
- Seating comfort
- Air conditioning function
- Comfort Package
- Entertainment
- Information and communication system
- Assistance systems
- Drivetrain
- Running gear, brakes and steering
- Transport and storage space

### Vehicle types

#### Models and packages

- Base
- M Sport package
- M Sport package Pro
- BMW M Vehicle

### Equipment

Equipment highlights

Wheels and tyres

Exterior colour world.  
BMW M vehicles

Interior colour world.  
BMW M vehicles

Genuine BMW Accessories

### Technical values

#### BMW Services

#### BMW X7 xDrive40i:

23" BMW Individual light-alloy V-spoke style wheels 914 | Bicolour Jet black, exterior colour in Sparkling Copper Grey metallic, BMW Individual full Merino leather ZBJJ Ivory White/Atlas Grey, BMW Individual interior trim finisher in Ash Flowing Grey, open-pored, fine-wood trim  
Fuel consumption in l/100 km (combined): 10.6–9.6  
CO<sub>2</sub> emissions in g/km (combined): 240–217

#### BMW X7 M60i:

M Sport package Pro, 22" M light alloy wheels V-spoke style 755 M Jet black, exterior colour in Frozen Marina Bay Blue Metallic, BMW Individual full Merino leather ZBSW Black, Carbon Fibre M interior trim  
Fuel consumption in l/100 km (combined): 12.9–12.1  
CO<sub>2</sub> emissions in g/km (combined): 292–273

The models illustrated in this medium show the equipment and configuration options (standard and optional) for vehicles produced by BMW AG for the German market. Alterations in standard and optional equipment and the configurations available for the different models, as described in this brochure, may occur. Your local BMW Partner is available to provide further details. Subject to change in design and equipment.



THE SOVEREIGN.





INDEPENDENCE IS MORE THAN  
A FEELING. IT IS KNOWING THAT YOU  
CAN ACHIEVE YOUR GOALS AT ANY TIME.  
CONFIDENCE IN ALL DECISIONS.  
FREE OF ALL CONVENTIONS.  
ANYWHERE. IN ANY SITUATION.  
BECAUSE YOU CAN.





CHARISMA,  
REDEFINED.





SUPERIORITY IS A FEATURE.  
THE BMW X7 INTRODUCES THE NEW  
AGE OF TRANSFORMATION AND  
MAKES A STATEMENT OF GRANDEUR.  
UNBRIDLED FORWARD THRUST  
MEETS LAVISH COMFORT.  
EXPERIENCE THE ALLURE OF PURE  
FREEDOM.





ELEGANCE

AS FAR AS THE  
EYE CAN SEE.



EXTERIOR DESIGN.



Illustrations and descriptions include optional equipment.

AN AURA OF FREEDOM,  
**DISTINCTIVE  
REAR.**





HIGHLIGHTS IN BLACK  
ADD SPORTY  
ACCENTS.





A real oasis of well-being: the interior of the BMW X7 is modern and luxurious – thanks to electrically adjustable comfort seats, the ambient lighting strip and refined controls. The generous Curved Display is an absolute highlight that makes a statement of forward-looking innovation and allows you to keep an eye on your destinations at all times.



INTERIOR DESIGN.

AN  
INTERIOR  
FULL OF COMFORT  
AND LUXURY.





Opens up new perspectives: the standard electric Panorama glass roof with sliding and lifting function creates a bright, light-flooded atmosphere. The optional Panorama glass roof Sky Lounge creates an atmospheric ambience, especially in the dark, thanks to LED-based light graphics.





INTERIOR DESIGN.

MORE SPACE FOR YOU.  
**MORE SPACE  
FOR LUXURY.**



LET'S WORDS BE  
**FOLLOWED**  
BY DEEDS.







Digitally on the road: interaction with the new infotainment system in the BMW X7 is as intuitive as it is uncomplicated thanks to voice control, gestures, i-Drive controller or via the touchscreen.



In the BMW X7 xDrive 40i you will experience more traction, irresistible dynamism and unlimited driving safety.

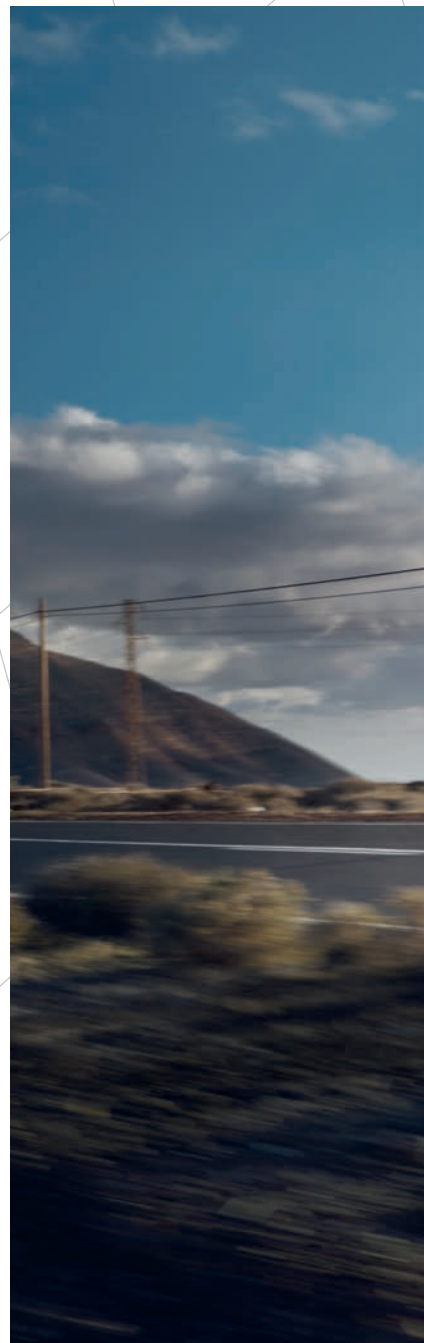



DRIVING PLEASURE PAR  
**EXCELLENCE.**





Illustrations and descriptions include optional equipment.





# ELEGANCE RELOADED.

The new BMW X7 fascinates in Sparkling Copper Grey, stands for a superior presence and reveals a new dimension of driving pleasure.





---

M SPORT PACKAGE.



THE SPORTY EDGE:  
**THE BMW X7 WITH  
M SPORT PACKAGE.**

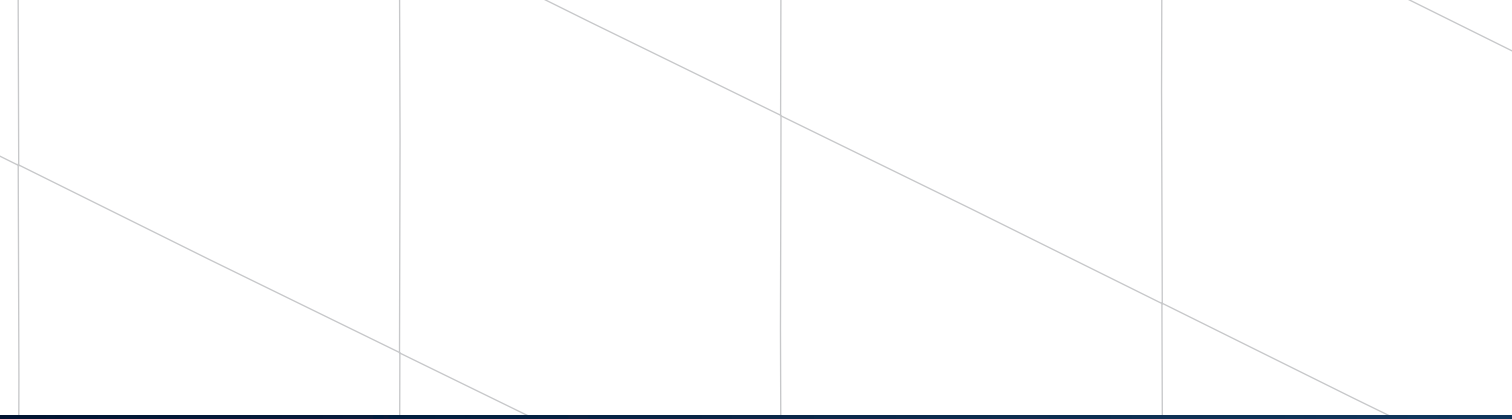



M60i xDRIVE.

PURE POWER:  
**THE BMW X7**  
**M60i xDRIVE.**



Illustrations and descriptions include optional equipment.





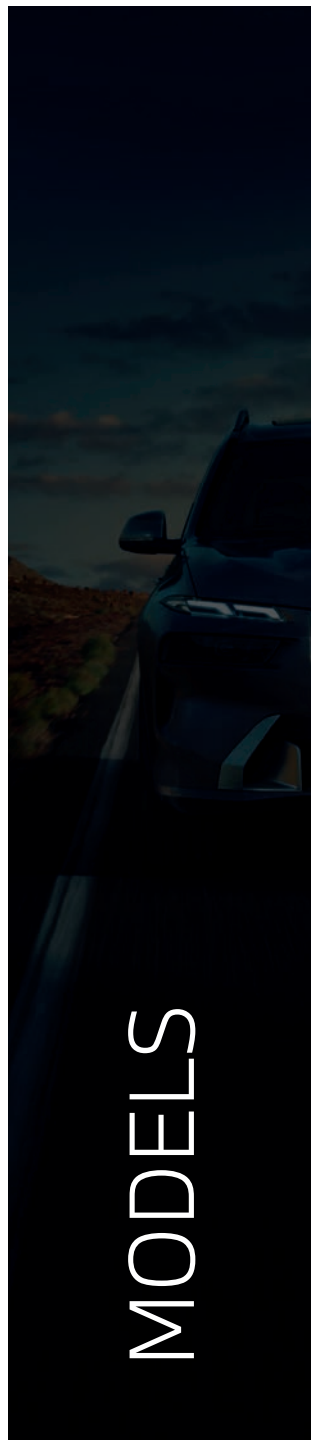
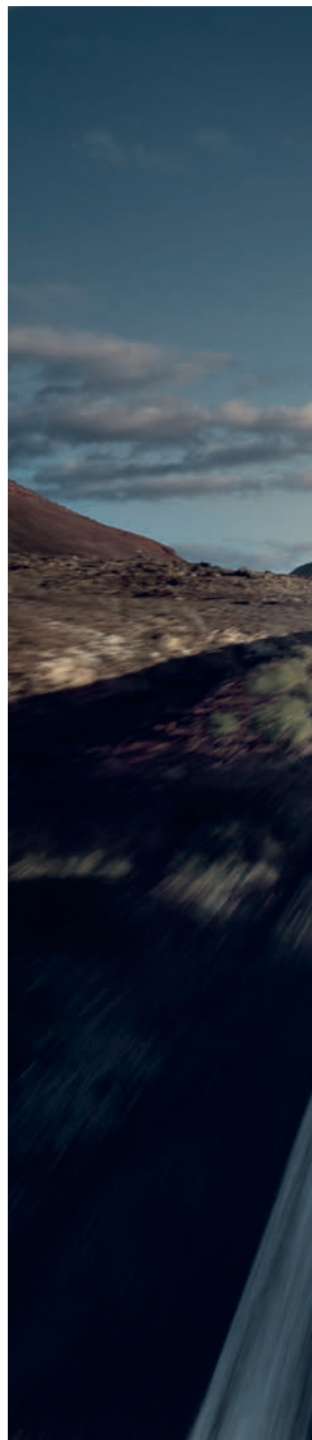

---

# MODEL VARIANTS AT A GLANCE.

---

## BASIC VERSION

Fascinatingly luxurious: THE BMW X7.



## M SPORT PACKAGE



The sporty edge: the BMW X7 with M Sport package.

## M SPORT PACKAGE PRO



High-gloss athleticism: the BMW X7 with M Sport package Pro.

---

## BMW M VEHICLE

---



Irresistibly dynamic: the BMW X7 M60i xDrive.

---



# BASE.



The standard black Sport leather steering wheel incl. multifunction with three spokes has a decorative trim in Pearl Chrome. A solid steering wheel rim and contoured thumb rests offer a particularly pleasant and high-grip feel. The airbag cover is also finished in leather.

The comfort seats for driver and front passenger fitted as standard include active head restraints and can be electrically adjusted in various ways. The top part of the backrest, the backrest width, thigh support and head restraint height can be individually adjusted. The equipment package also includes the lumbar support and memory function for the driver and front passenger.



20" light alloy wheels V-spoke style 750 Reflex Silver with run-flat tyres, wheel size 8.5J x 20 with 275/50 R20 tyres.

## SELECTED BASE MODEL EXTERIOR EQUIPMENT FEATURES:

- Panorama glass sunroof
- Acoustic glazing
- Roof rails, Matt Aluminium
- Light alloy wheels
- Adaptive LED Headlights incl. High-beam Assistant and LED rear lights
- Automatic operation for two-part tailgate
- Comfort Access

## SELECTED BASE MODEL INTERIOR EQUIPMENT FEATURES:

- BMW Live Cockpit Plus with BMW Curved Display
- BMW Operating System 8.5 with navigation
- Comfort seats with electric seat adjustment and memory, front
- Seat covers and instrument panel upper section in Sensafin
- Seat heating for driver and front passenger
- Air conditioning, automatic with 4-zone control
- Sport leather steering wheel
- Ambient interior lighting incl. Light Bar
- Illuminated entry sills
- Folding rear seat backrest, 40:20:40 configuration

The availability of some equipment features, functions and digital services depends on engine versions or additional optional equipment. The offer structure as well as market and production availability may vary.

For detailed information about availabilities, duration and costs, contact your local BMW authorised workshop.

# M SPORT PACKAGE.



The M leather steering wheel including multifunction buttons, an M badge and an integrated driver-side airbag is featured in three-spoke design. With a reinforced steering wheel rim in leather 'Walknappa' Black, with black stitching and contoured thumb rests, it conveys a sporty, direct steering sensation – not least thanks to integrated shift paddles.



The M High-gloss Shadowline exterior trim contains numerous equipment details in Black high-gloss: side window graphics, B and C-pillars as well as window guide bars, mirror triangle and mirror frame. All trim elements below the sill line feature the same look to match.



The M headliner in Alcantara anthracite, featuring matching sun visors and body pillars lined in anthracite, gives the interior a particularly high-quality and exclusive look. The sliding headliner has a cloth finish.



21" M light alloy wheels Double-spoke style 754 M Bicolour Orbit Grey with run-flat tyres, gloss-lathed, wheel size 9.5J x 21 with 285/45 R21 tyres.

## SELECTED M SPORT PACKAGE EXTERIOR EQUIPMENT:

- M Aerodynamics package with front and rear apron, side sills and wheel arch trims in body colour
- 21" M light alloy wheels Double-spoke style 754 M Bicolour with emergency running properties; other wheels available
- M High-gloss Shadowline, alternatively BMW Individual Exterior Line Satin Aluminium<sup>1</sup>
- M designation on the sides
- Specific design elements in Black high-gloss and Dark Shadow metallic
- Tailpipe trim in M Sport package-specific geometry
- M roof rails high-gloss Shadowline, alternatively roof rails Matt Aluminium

## SELECTED M SPORT PACKAGE INTERIOR EQUIPMENT:

- Door sill finishers with M designation, M driver footrest and M specific pedals
- Comfort seats for driver and front passenger in Sensafin decorative stitching Black; other upholstery available
- M leather steering wheel
- M Alcantara anthracite headliner
- Interior trim in Finition Black fine-wood trim with high-gloss metal effect; other trims available
- Instrument cluster with M specific display in SPORT and SPORT+ mode

<sup>1</sup> If the BMW Individual Exterior Line Satin Aluminium is chosen, all the Black exterior elements are replaced by Chrome exterior elements.

The availability of some equipment features, functions and digital services depends on engine versions or additional optional equipment. The offer structure as well as market and production availability may vary. For detailed information about availabilities, duration and costs, contact your local BMW authorised workshop.



# BMW M VEHICLE.



The M leather steering wheel including multifunction buttons, an M badge and an integrated driver-side airbag is featured in three-spoke design. With a reinforced steering wheel rim in leather 'Walknappa' Black, with black stitching and contoured thumb rests, it conveys a sporty, direct steering sensation – not least thanks to integrated shift paddles.



The M sport exhaust system delivers a sound that can be adjusted to an even more intense engine sound with the driving dynamics buttons in the SPORT and SPORT+ programmes, while the comfort-oriented programme prioritises more discreet engine acoustics.



22" M light alloy wheels V-spoke style 755 M Jet Black with mixed tyres and performance tyres, wheel size front 9.5J x 22 with 275/40 R22 tyres, wheel size rear 10.5J x 22 with 315/35 R22 tyres.

## SELECTED BMW M VEHICLE EXTERIOR EQUIPMENT RANGES:

- M Aerodynamics package
- M Double-stemmed kidney grille with M badge, illuminated 'Iconic Glow'
- Panorama glass sunroof
- M Sport exhaust system
- M roof rails high-gloss Shadowline
- M light alloy wheels
- M exterior mirror caps
- Adaptive LED Headlights incl. High-beam Assistant and LED rear lights
- Automatic actuation for two-part tailgate
- Acoustic glazing
- Comfort Access

## SELECTED BMW M VEHICLE INTERIOR EQUIPMENT RANGES:

- BMW Live Cockpit Plus with BMW Curved Display
- BMW Operating System 8.5 with navigation
- Comfort seats with electric seat adjustment and memory, front
- Seat covers and instrument panel upper section in Sensafin
- Seat heating for driver and front passenger
- M Alcantara anthracite headliner
- Harman Kardon surround sound system
- Air conditioning, automatic with 4-zone control
- M leather steering wheel
- Ambient interior lighting incl. M-specific ambient lighting strip
- Illuminated entry sills with M60i inscription
- Folding rear seat backrest, 40:20:40 configuration

The availability of some equipment features, functions and digital services depends on engine versions or additional optional equipment. The offer structure as well as market and production availability may vary.

For detailed information about availabilities, duration and costs, contact your local BMW authorised workshop.





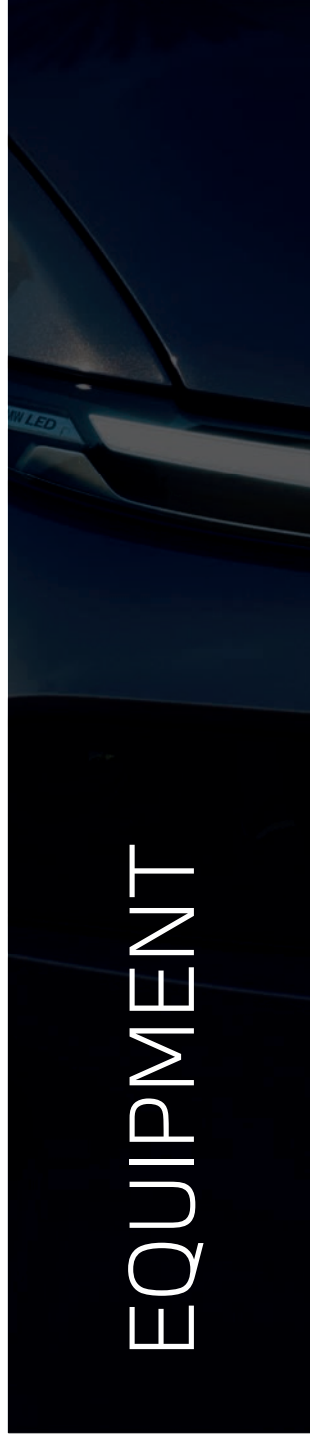
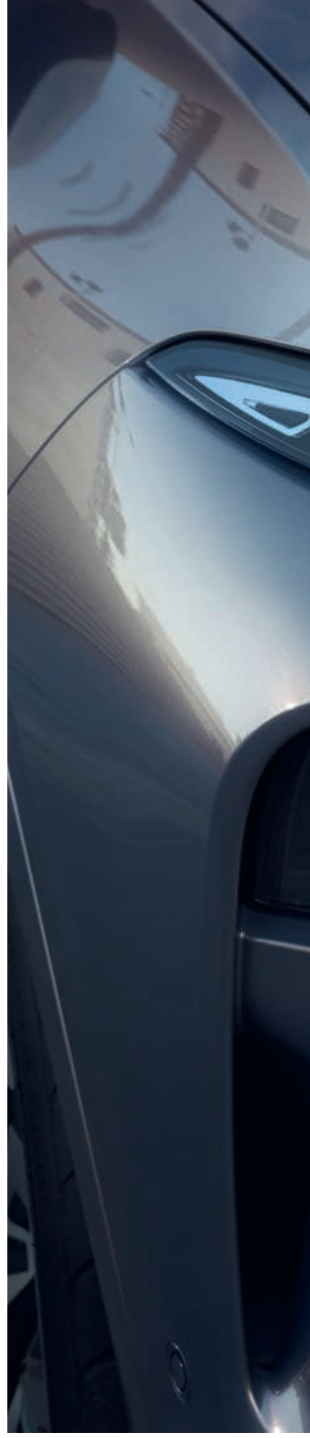

# EXTERIOR & VISION.

Discover select standard and optional equipment highlights. Some of the optional equipment shown is not included in the basic price.



The BMW kidney 'Iconic Glow' sets impressive visual highlights. With its innovative LED ambient lighting, it enables sensational light scenarios – for example while driving or when opening and closing your vehicle.



The standard Adaptive LED headlights include low-beam and no-dazzle high-beam headlights (BMW Selective Beam) as well as direction indicators in full-LED technology. The equipment also features cornering lights, daytime running lights and Adaptive headlights with variable light control for excellent illumination of the road ahead and better visibility in the dark.



The standard High-beam Assistant supports driving in the dark by automatically adjusting the headlights in response to oncoming traffic or vehicles up ahead. Where there is sufficient ambient light, for example in built-up areas, it reacts by automatically switching off the high-beam.

The availability of some equipment features, functions and digital services depends on engine versions or additional optional equipment. The offer structure as well as market and production availability may vary.

For detailed information about availabilities, duration and costs, contact your local BMW authorised workshop.



# EXTERIOR & VISION.

Discover select standard and optional equipment highlights. Some of the optional equipment shown is not included in the basic price.



The Aluminium running board with a brushed, anodised surface and rubber inserts adds a particularly distinctive touch and makes getting in and out of the vehicle more convenient.



The standard Ambient light<sup>1</sup> includes the ambient contour lighting and creates a relaxing, cosy lighting atmosphere in the interior. The 15 dimmable lighting designs also offer a dynamic function in four applications. The Welcome Light Carpet illuminates the area in front of the vehicle doors when entering and exiting.

<sup>1</sup> The contour lighting can be combined in white or ambient light colour.

The availability of some equipment features, functions and digital services depends on engine versions or additional optional equipment. The offer structure as well as market and production availability may vary. For detailed information about availabilities, duration and costs, contact your local BMW authorised workshop.

# INTERIOR.

Discover select standard and optional equipment highlights. Some of the optional equipment shown is not included in the basic price.



The top of the BMW Individual instrument panel is covered in leather 'Walknappa'. The sophisticated aesthetic of this high-quality trim gives the interior an even more luxurious optic.

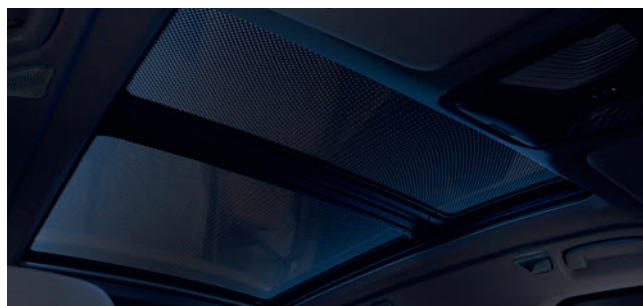

The Panorama glass roof Sky Lounge creates an atmospheric ambience, especially in the dark, with a light graphic composed of over 15,000 lighting elements. The light design can be switched between 15 Ambient light colours.



The M headliner in Alcantara anthracite, featuring matching sun visors and body pillars lined in anthracite, gives the interior a particularly high-quality and exclusive look. The sliding headliner has a cloth finish.



The 'CraftedClarity' glass application comprises hand-made glass elements that visually and tactilely enhance the interior. The details of the selector lever, BMW Controller and Start/Stop button are made of fine crystal.

The availability of some equipment features, functions and digital services depends on engine versions or additional optional equipment. The offer structure as well as market and production availability may vary.

For detailed information about availabilities, duration and costs, contact your local BMW authorised workshop.



# SEATING COMFORT.

Discover select standard and optional equipment highlights. Some of the optional equipment shown is not included in the basic price.



The Massage function for driver and passenger improves the physical wellbeing by stimulating or relaxing certain muscle groups. There are eight massage programmes dedicated to different parts of the body. The operating elements are easily accessible in the door next to the door opener lever.



Even before the engine has reached its operating temperature, the seat heating for driver and front passenger fitted as standard provides pleasant warmth, adjustable in three levels. The heat elements warm the surface of the seat, the side bolsters, and the entire contact surface of the backrest.



Thanks to the two individually moveable and adjustable individual seats in the 2nd row of seats with 6 seats in the vehicle, rear passengers enjoy a higher level of travel comfort. At the same time, access to the 3rd row of seats is facilitated.



The standard electric seat adjustment with memory function allows the desired settings for seat, exterior mirror and steering wheel to be stored.



In warm weather, the front active seat ventilation provides a cool and pleasant seat temperature, resulting in a more comfortable driving experience.



The M Multifunctional seats for driver and front passenger in exclusive design offer comprehensive adjustment possibilities and provide perfect support.

The availability of some equipment features, functions and digital services depends on engine versions or additional optional equipment. The offer structure as well as market and production availability may vary.

For detailed information about availabilities, duration and costs, contact your local BMW authorised workshop.

# AIR CONDITIONING FUNCTION.

Discover select standard and optional equipment highlights. Some of the optional equipment shown is not included in the basic price.



The roller sunblind for the rear side windows can be retracted and extended electrically. It protects against sunlight and offers privacy.

The slight tinted heat/sun protection glazing of the side and rear windows prevents the interior from heating up.



Thanks to the automatic air conditioning with 5-zone control, the temperature for you, your front passenger, the left and right sides of the 2nd row of seats and for the 3rd row of seats can be set independently of one another. Each fellow traveller can thus enjoy the most pleasant climate for him or her. A nanoparticle filter for fresh and recirculated air improves the air quality.



The Ambient Air Package comprises a fragrance dispersal function and an air ionisation function. There are ten fragrances to choose from, all specially composed for the vehicle. The Starter kit includes two fragrances: Blue Suite No. 1 and Golden Suite No. 2.

The availability of some equipment features, functions and digital services depends on engine versions or additional optional equipment. The offer structure as well as market and production availability may vary.

For detailed information about availabilities, duration and costs, contact your local BMW authorised workshop.



# COMFORT PACKAGE.

More relaxed journeys with the Comfort Package. This is ensured, among other things, by front and rear seat heating, Heat Comfort package and temperature-adjustable cup holders.



The Heat Comfort package front provides the driver and front passenger with cosy warmth for the arms and hands as well, increasing comfort, particularly during cold times of the year. The Heat Comfort package front also includes heated armrests on the doors and front centre console, as well as steering wheel heating.



The seat heating regulates the temperature of the seat and backrest surfaces of the front and outer rear seats of the 2nd and 3rd row of seats and can be individually adjusted in three stages for each seat. Even before the engine has reached running temperature, the seat heating provides cosy warmth even in the coldest exterior temperatures – and all that at the push of a button.

The temperature-controlled cup holders in the centre console can individually cool or keep stored beverages warm at the touch of a button.



The availability of some equipment features, functions and digital services depends on engine versions or additional optional equipment. The offer structure as well as market and production availability may vary..

For detailed information about availabilities, duration and costs, contact your local BMW authorised workshop.

# ENTERTAINMENT.

Discover select standard and optional equipment highlights. Some of the optional equipment shown is not included in the basic price.



The Bowers & Wilkins Diamond surround sound system with two diamond tweeters offers outstanding studio sound quality on all seats in the vehicle, including 3D surround sound. 20 carefully positioned speakers with a total output of 1,475 W provide a mesmerising sound experience. Individual speakers are highlighted with specific illumination, visually emphasising the system's outstanding sound quality.



The Harman Kardon surround sound system features a 464 W digital amplifier, nine channels, vehicle-specific equalising and 16 speakers.



More order, more comfort: With the wireless charging tray, you can charge your smartphone wirelessly and thus extremely conveniently.



With smartphone integration<sup>1</sup>, your vehicle supports Apple CarPlay and Android Auto. This way, you can access your usual apps in the vehicle.



Whether navigation or smartphone integration – the digital services of the Connected Package Professional<sup>2</sup> leave nothing to be desired.

With the Personal eSIM<sup>3</sup>, you can use your mobile communications contract for your BMW. Advantages: simplified operation, improved reception, 5G mobile access.

<sup>1</sup> Smartphone integration is permanently available in the vehicle. It includes Apple CarPlay and Android Auto.

<sup>2</sup> Smartphone integration is permanently available in the vehicle. It includes Apple CarPlay and Android Auto. Due to possible future technical developments (e.g. of mobile phones), the usability of the Apple CarPlay or Google Android Auto service cannot be guaranteed permanently. CarPlay is a trademark of Apple Inc. Android Auto is a trademark of Google LLC. Android Auto linking is only possible in conjunction with a BMW Live Cockpit. To use optional equipment other optional equipment may be necessary.

<sup>3</sup> Availability may vary depending on the market and the customer's mobile service provider. More detailed information on this can be accessed on the BMW website or the My BMW App. This service only works with an existing mobile contract between the customer and their mobile service provider that includes the eSIM option. Customers

can check the availability of the eSIM contract option with their mobile service provider. If your mobile communications provider does not support the eSIM option, you can use a NANO SIM card with the SIM reader (available as an option) to still be able to use the functions of the Personal eSIM in your BMW. Fees may apply when using the service. These are collected by the mobile service provider as part of the mobile communications contract (use of data and/or telephony via the Personal eSIM).

The availability of some equipment features, functions and digital services depends on engine versions or additional optional equipment. The offer structure as well as market and production availability may vary. For detailed information about availabilities, duration and costs, contact your local BMW authorised workshop.



# INFORMATION & COMMUNICATION

Discover select standard and optional equipment highlights. Some of the optional equipment shown is not included in the basic price.



Keeping an eye on what's important: the BMW Live Cockpit Professional with a large Curved Display, Head-up display and the Augmented View destination guidance experience.

BMW Live Cockpit Plus<sup>1</sup> includes a high-quality display cluster consisting of a 14.9" control display and a fully digital 12.3" instrument display.



With BMW Gesture Control, certain functions can be operated by means of defined hand movements. For certain operations the system will for example recognise gestures such as 'swiping' or 'pointing' for accepting or rejecting an incoming call, or circular motions of the index finger to adjust volume.



The Travel & Comfort System<sup>2,3</sup> includes two additional USB ports and a preparation for multifunction holders in the rear of the vehicle.

<sup>1</sup> Smartphone integration is not compatible with all smartphones and apps.

<sup>2</sup> Note: Various Travel & Comfort components are available through Original BMW Accessories for the multifunction holder due to the modular design of the plug-in coupling.

<sup>3</sup> Not available in conjunction with the M multifunction seats.

The availability of some equipment features, functions and digital services depends on engine versions or additional optional equipment. The offer structure as well as market and production availability may vary. For detailed information about availabilities, duration and costs, contact your local BMW authorised workshop.

# ASSISTANCE SYSTEMS.

Discover select standard and optional equipment highlights. Some of the optional equipment shown is not included in the basic price.

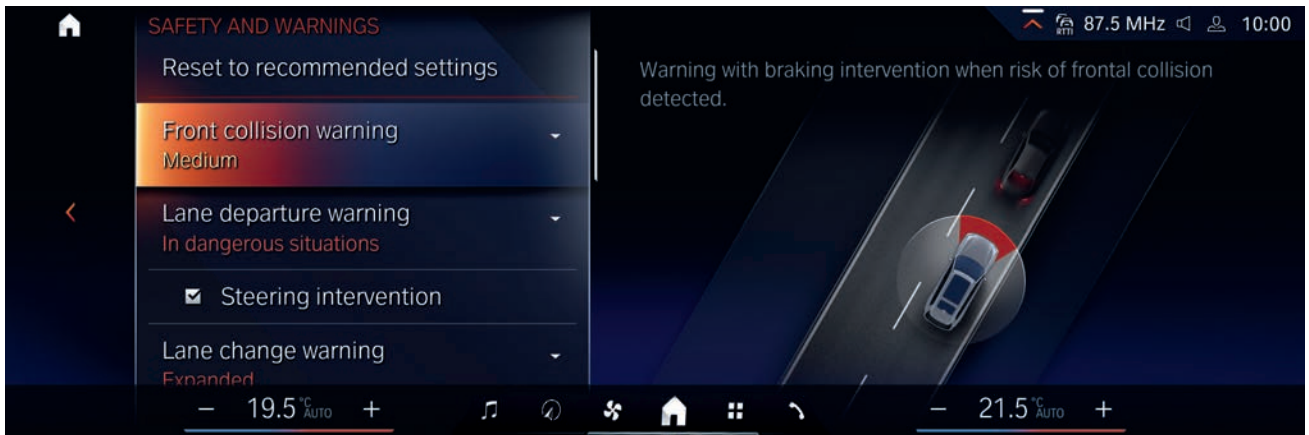

Driving Assistant<sup>1</sup> Professional automatically maintains lane, speed and distance and reduces the risk of accidents in numerous situations.

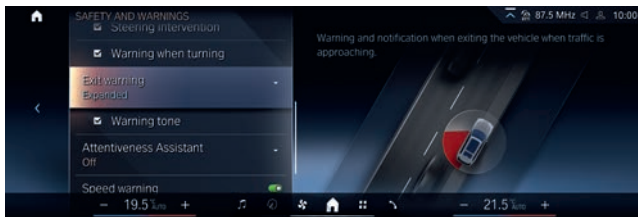

Whether it's an imminent frontal collision or rear-end cross-traffic – Driving Assistant warns and brakes independently if necessary. It helps to prevent accidents when changing lanes and getting out of the car. It also warns following traffic of an impending rear-end collision. The system can also reduce the risk of exceeding speed limits.



Parking Assistant makes it easier for you to park and manoeuvre in tight spaces. The Reversing Assist Camera, distance sensors and an emergency braking function prevent parking damage. In addition, your BMW recognises suitable parking spaces as you drive past and parks automatically if necessary. Practical: The Reversing Assistant supports you, for example, in narrow driveways.

The availability of some equipment features, functions and digital services depends on engine versions or additional optional equipment. The offer structure as well as market and production availability may vary. For detailed information about availabilities, duration and costs, contact your local BMW authorised workshop.

<sup>1</sup> This function can be limited by darkness and fog.



# DRIVETRAIN.

Discover select standard and optional equipment highlights. Some of the optional equipment shown is not included in the basic price.



The intelligent BMW xDrive all-wheel drive system smoothly distributes variable driving power to the front and rear wheels. As a result, you benefit from more traction and driving dynamics in all driving situations. For improved driving safety, the system also specifically counteracts understeering and oversteering in bends.



The Executive Drive Pro Suspension control system ensures exceptional driving comfort at the same time as outstanding driving dynamics. The system is based on active roll stabilisers that continuously regulate electromechanically while driving, thus reducing body inclinations to a minimum.



The 8-speed Steptronic sport transmission allows you both comfortable sliding gear changes and a dynamic driving style with very sporty gear changes – automatically and also manually via shift paddles. In SPORT mode and when operating the electronic selector lever (switch: S/M), the gear shifts are configured for maximum performance.



Mild hybrid technology<sup>1</sup> is used to recover braking energy and supports the combustion engine during acceleration with electric power. This reduces fuel consumption and emissions while giving you a dynamic advantage. The mild hybrid technology also makes the Automatic Start/Stop function much faster and much more comfortable.

<sup>1</sup> Only available for certain engine types/countries.

The availability of some equipment features, functions and digital services depends on engine versions or additional optional equipment. The offer structure as well as market and production availability may vary. For detailed information about availabilities, duration and costs, contact your local BMW authorised workshop.

# SUSPENSION, BRAKES AND STEERING.

Discover select standard and optional equipment highlights. Some of the optional equipment shown is not included in the basic price.



The standard Adaptive 2-axle air suspension makes driving particularly comfortable with high driving dynamics and makes it easier to get in and out and load the vehicle. The air suspension automatically keeps the vehicle at a constant height regardless of the load. It can also be raised or lowered manually at the touch of a button.



The BMW X7 features an xOffroad package that allows you to travel safely and quickly on the road as well as on less solid surfaces at all times. Four selectable off-road modes adapt the all-wheel drive xDrive even more precisely to the current driving surface – for even better traction on sand, rocks, gravel or snow.



The Driving Experience Control offers the driver the choice between the standard COMFORT mode, ECO PRO Mode, geared towards efficiency, and SPORT mode, which enables even more dynamic driving.



Integral Active Steering combines support that varies based on the steering angle on the front axle, and rear wheels that also contribute to steering. From 1 to 2 km/h, it offers greater manoeuvrability and agility by turning the rear wheels opposite the front wheels. Beginning around 60 to 80 km/h, the rear wheels turn parallel to the front wheels, to increase driving stability and comfort.

The availability of some equipment features, functions and digital services depends on engine versions or additional optional equipment. The offer structure as well as market and production availability may vary.

For detailed information about availabilities, duration and costs, contact your local BMW authorised workshop.



# TRANSPORT AND STORAGE SPACE.

Discover select standard and optional equipment highlights. Some of the optional equipment shown is not included in the basic price.



The trailer tow hitch with electrically adjustable tow ball is approved for heavy loads of up to 3,500 kg. In order to stabilise, the trailer stability control automatically brakes the pulling vehicle if the trailer begins to swing. The electronically adjustable tow ball is not visible when stowed under the rear apron.



The Comfort Access<sup>1</sup> makes it possible to open all of the vehicle doors and the luggage compartment, without using the key. When approaching, the welcome greeting is activated even before the doors unlock automatically. You can additionally set up BMW Digital Key on a smartphone – if compatible – or use the Key Card for accessing and starting the vehicle.



Both the upper and lower sections of the tailgate can be opened and closed electrically with the automatic tailgate operation. This facilitates access and loading of the luggage compartment. The lower part of tailgate can also be used as a practical seat.

<sup>1</sup> BMW Digital Key is compatible with selected smartphones only. A list of compatible smartphones is available at [bmw.com/digitalkey](https://www.bmw.com/digitalkey). The use of BMW Digital Key requires the Teleservices (S6AEA) equipment.

The availability of some equipment features, functions and digital services depends on engine versions or additional optional equipment. The offer structure as well as market and production availability may vary. For detailed information about availabilities, duration and costs, contact your local BMW authorised workshop.

# EQUIPMENT HIGHLIGHTS. BMW M VEHICLE.



Kidney frame in chrome.



The M leather steering wheel including multifunction buttons, an M badge and an integrated driver-side airbag is featured in three-spoke design. With a reinforced steering wheel rim in leather 'Walknappa' Black, with black stitching and contoured thumb rests, it conveys a sporty, direct steering sensation – not least thanks to integrated shift paddles.

The M Sport brake has four-piston fixed callipers at the front and single-piston floating callipers at the rear in blue with the M designation and features large brake discs to ensure an outstanding braking performance.



The M Carbon mirror caps emphasise the powerful, sporty design of the vehicle.

The availability of some equipment features, functions and digital services depends on engine versions or additional optional equipment. The offer structure as well as market and production availability may vary..

For detailed information about availabilities, duration and costs, contact your local BMW authorised workshop.



# EQUIPMENT HIGHLIGHTS. BMW M VEHICLE.



The Executive Drive Pro Suspension control system ensures exceptional driving comfort at the same time as outstanding driving dynamics.



The M TwinPower Turbo V8-cylinder petrol engine with two turbochargers achieves impressive power characteristics while maintaining high efficiency.

Integral Active Steering boosts manoeuvrability and agility at lower speeds while improving stability at higher speeds.



BMW M specific ambient lighting strip.



The M sport exhaust system delivers a sound that can be adjusted to an even more intense engine sound with the driving dynamics buttons in the SPORT and SPORT+ programmes, while the comfort-oriented programme prioritises more discreet engine acoustics.



BMW M door sill trim.



BMW M side elements.

The availability of some equipment features, functions and digital services depends on engine versions or additional optional equipment. The offer structure as well as market and production availability may vary.

For detailed information about availabilities, duration and costs, contact your local BMW authorised workshop.

# WHEELS AND TYRES.

23" BMW Individual light alloy wheels V-spoke style 914 I Bicolour Jet Black with mixed tyres and performance tyres, gloss-lathed, wheel size front 9.5J x 23 with 275/35 R23 tyres, wheel size rear 10.5J x 23 with 315/30 R23 tyres.



20" light alloy wheels V-spoke style 750 Reflex Silver with run-flat tyres, wheel size 8.5J x 20 with 275/50 R20 tyres.<sup>1</sup>

21" M light alloy wheels Double-spoke style 754 M Bicolour Orbit Grey with run-flat tyres, gloss-lathed, wheel size 9.5J x 21 with 285/45 R21 tyres.<sup>2</sup>



22" light alloy wheels V-spoke style 756 Bicolour Orbit Grey with mixed tyres, gloss-lathed, front 9.5J x 22 with 275/40 R22 tyres, rear 10.5J x 22 with 315/35 R22 tyres.

22" M light alloy wheels Double-spoke style 913 M Bicolour Black Grey with mixed tyres and run-flat tyres, gloss-lathed, wheel size front 9.5J x 22 with 275/40 R22 tyres, wheel size rear 10.5J x 22 with 315/35 R22 tyres.

21" light alloy wheels Y-spoke style 753 Bicolour Ferric Grey with run-flat tyres, gloss-lathed, wheel size 9.5J x 21 with 285/45 R21 tyres.

21" light alloy wheels Y-spoke style 752 Jet Black with run-flat tyres, wheel size 9.5J x 21 with 285/45 R21 tyres.



22" light alloy wheels Multi-spoke style 757 Bicolour Ferric Grey with mixed tyres, gloss-lathed, front 9.5J x 22 with 275/40 R22 high-performance tyres, rear 10.5J x 22 with 315/35 R22 high-performance tyres.

22" M light alloy wheels V-spoke style 755 M Jet Black with mixed tyres and run-flat tyres, wheel size front 9.5J x 22 with 275/40 R22 tyres, wheel size rear 10.5J x 22 with 315/35 R22 tyres.

<sup>1</sup> Standard equipment.

<sup>2</sup> Standard equipment for the M60i xDrive.

The availability of some equipment features, functions and digital services depends on engine versions or additional optional equipment. The offer structure as well as market and production availability may vary. For detailed information about availabilities, duration and costs, contact your local BMW authorised workshop.



# EXTERIOR COLOURS.

## SOLID



Non-metallic 300 Alpine White

## METALLIC



Metallic 416 M Carbon Black<sup>1</sup>



Metallic 475 Black Sapphire



Metallic A96 Mineral White



Metallic C1K M Marina Bay Blue<sup>2</sup>

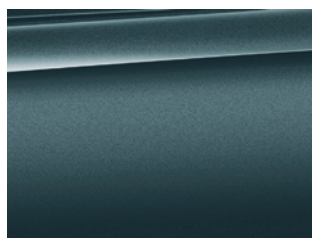

Metallic C35 Blue Ridge Mountain

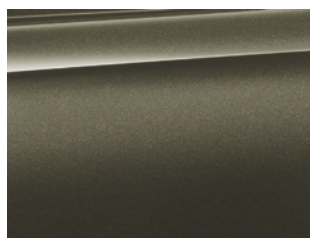

Metallic C3D Manhattan

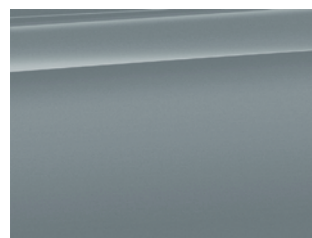

Metallic C4P M Brooklyn Grey

## BMW INDIVIDUAL



C57 Aventurine Red metallic

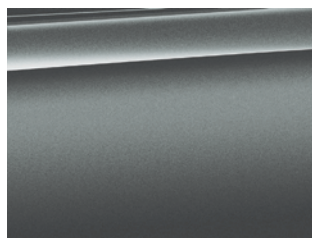

Metallic C4W Skyscraper Grey

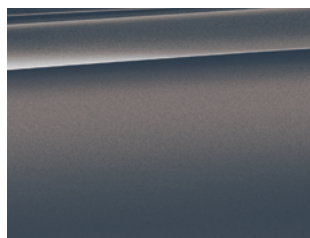

Metallic C55 Sparkling Copper Grey

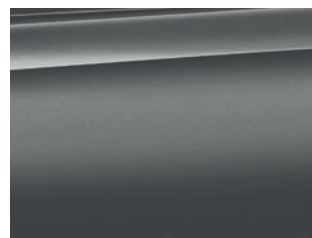

BMW Individual C5A Frozen Pure Grey metallic

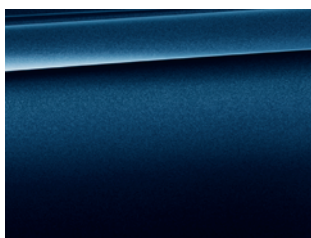

BMW Individual C3Z Tanzanite Blue metallic

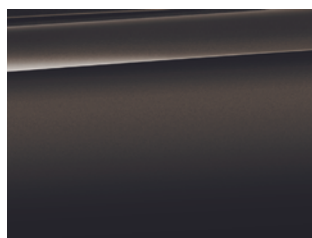

BMW Individual C36 Dravit Grey metallic

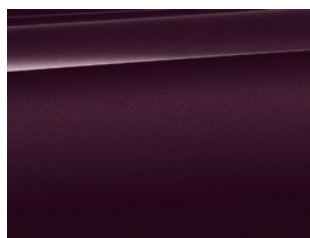

BMW Individual X1B Ametrine metallic

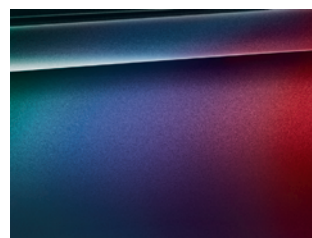

BMW Individual 490 special paintwork (up to 150 paints available)

**[ Colour samples ]** These colour samples are intended as an initial guide to the colours and materials available for your BMW. However, experience has shown that printed versions of paint, upholstery and interior trim colours cannot in all cases faithfully reproduce the appearance of the original colour. Please discuss your preferred colour choices with your BMW partner or in your dealership. There you can also see original samples and be assisted with special requests.

<sup>1</sup> Only in conjunction with the M Sport package.

<sup>2</sup> Only in conjunction with the M60i xDrive.



Make an individual statement. BMW Individual special paintwork offers you countless possibilities to highlight the exclusivity of your BMW X7 Series. Simply scan the QR code or ask your Authorised BMW Retailer.

The availability of some equipment features, functions and digital services depends on engine versions or additional optional equipment. The offer structure as well as market and production availability may vary.

For detailed information about availabilities, duration and costs, contact your local BMW authorised workshop.

# INTERIOR COLOURS.

## INTERIOR TRIM FINISHERS

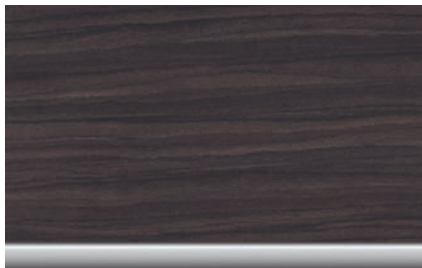

'Fineline' Brown lime wood open-pored fine-wood interior trim



Fine-wood trim 'Fineline Stripe' brown high-gloss<sup>3</sup>

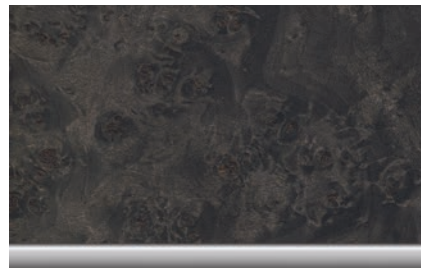

Fine-wood trim poplar grain anthracite-brown open-pored



Fine-wood trim 'Fineline' Black with metal effect high-gloss<sup>1</sup>

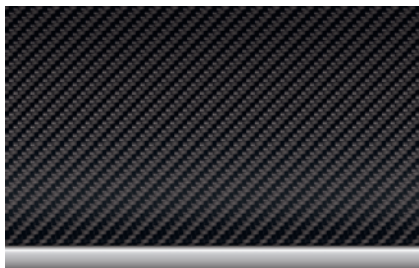

M interior trim finishers 'Carbon Fibre'<sup>1</sup>

## INDIVIDUAL INTERIOR TRIM



BMW Individual interior trim finishers fine-wood trim Ash Grain Silver Grey high-gloss

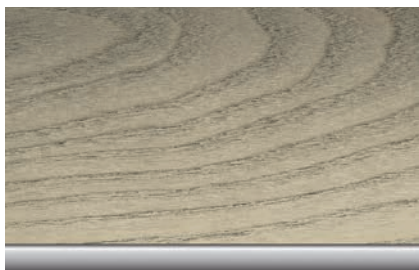

BMW Individual interior trim Ash Flowing Grey open-pored fine-wood<sup>2</sup>



BMW Individual interior trim finishers piano finish Black

<sup>1</sup> Only in conjunction with M Sport package or M Vehicle.

<sup>2</sup> Only in conjunction with ambient lighting

<sup>3</sup> Standard equipment.

The availability of some equipment features, functions and digital services depends on engine versions or additional optional equipment. The offer structure as well as market and production availability may vary.

For detailed information about availabilities, duration and costs, contact your local BMW authorised workshop.



# INTERIOR COLOURS.

## INTERIOR TRIM FINISHERS

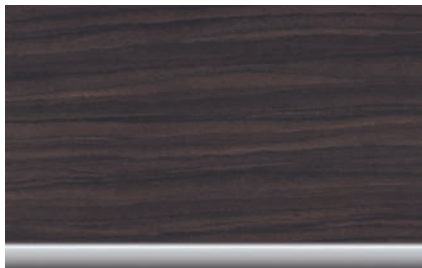

'Fineline' Brown lime wood open-pored fine-wood interior trim



Fine-wood trim 'Fineline Stripe' brown high-gloss<sup>3</sup>

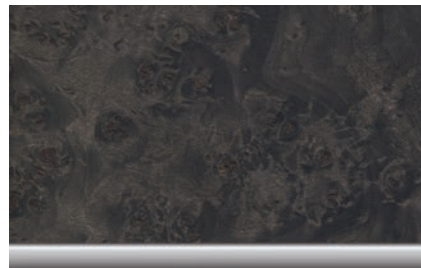

Fine-wood trim poplar grain anthracite-brown open-pored



Fine-wood trim 'Fineline' Black with metal effect high-gloss<sup>1</sup>

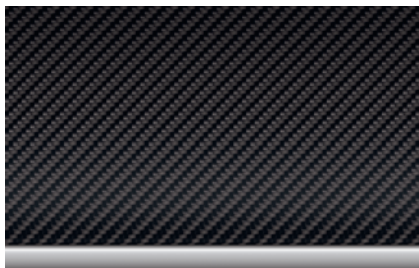

M interior trim finishers 'Carbon Fibre'<sup>1</sup>

## INDIVIDUAL INTERIOR TRIM



BMW Individual interior trim finishers fine-wood trim Ash Grain Silver Grey high-gloss

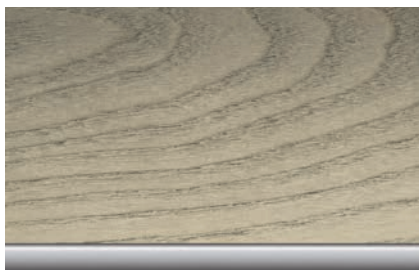

Ash Flowing Grey open-pored fine-wood BMW Individual interior trim<sup>2</sup>



BMW Individual interior trim finishers piano finish Black

<sup>1</sup> Only in conjunction with M Sport package or M Vehicle.

<sup>2</sup> Only in conjunction with ambient lighting

<sup>3</sup> Standard equipment.

The availability of some equipment features, functions and digital services depends on engine versions or additional optional equipment. The offer structure as well as market and production availability may vary. For detailed information about availabilities, duration and costs, contact your local BMW authorised workshop.



## ORIGINAL BMW ACCESSORIES.

Intensive driving experiences, even further enhanced: Original BMW accessories are the best match for an original BMW. Whether you're looking for wheels and tyres, transport and luggage compartment solutions, interior equipment, communication, information and technology, charging accessories or M performance parts, with genuine BMW accessories you'll find exactly the individual solution that will allow you to discover driving pleasure as if for the first time.



### WHEELS AND TYRES.

With original BMW complete wheels, you'll reach your destination safely, and emphasise the sporty appearance of your BMW from the very first glance. But what you don't immediately realise is that they are precisely tailored to your BMW, are subject to very stringent tests with intensive material and function checks, and have been developed in close collaboration with leading tyre manufacturers – individually tuned to the driving dynamics and design language of each individual BMW model.

### TRANSPORT AND LUGGAGE COMPARTMENT SOLUTIONS.

Original BMW Accessories offer you a wide range of transport and luggage compartment solutions. In line with your personal preferences and interests, you can use them to create additional space whenever and wherever you need it. Whether carrier systems or accessories for the luggage compartment, you can always rely on original BMW accessories to be precisely tailored to your BMW, and easy to use.





---

## INTERIOR ACCESSORIES.

A perfect fit: all original BMW accessory products for the interior help to design the interior of your BMW to fully meet your personal preferences. In addition to the excellent functionality of original BMW accessories, you are also always choosing attractive BMW design alongside extraordinary craftsmanship and material quality – combined with an ambience that will excite you every time you drive.



---

## COMMUNICATION, INFORMATION AND TECHNOLOGY.

Cutting-edge functions and features for maximum freedom and flexibility: Original BMW accessories for communication, information and technology are always at your side. Whether you value optimum availability by phone or the best sound, the innovative original BMW accessories will have the right solution for you. You'll always enjoy a good connection and custom entertainment, wherever your journey takes you.

---

## CHARGING ACCESSORIES.

Regardless of where and how you want to charge your new BMW, original BMW charging accessories offer you tailor-made products and services. You can charge your BMW at any domestic socket using the BMW Flexible Fast Charger or, for even more convenience, at a BMW Wallbox from original BMW accessories; what's more, there's also a widespread network of public charging points available for when you're on the road. Innovative Connected Charging services show charging stations in your BMW's information display, for example, or enable you to easily start pre-conditioning your vehicle just using your smartphone.



---

## M PERFORMANCE PARTS.

With M performance parts, you can experience BMW's motorsport DNA with fascinating intensity, even off the racetrack. A wide range of technical and visual components makes outstanding technology a visible and tangible experience. Exclusive materials and first-rate quality guarantee flawless dynamism. Experience inspiring maximum product performance: individual, expressive and uncompromising.

The availability of the equipment shown and described may vary on a market-specific basis. Your local BMW partner will be happy to advise you on the full range of original BMW accessories.

Discover the whole range of original BMW accessories and the BMW M performance parts product portfolio.







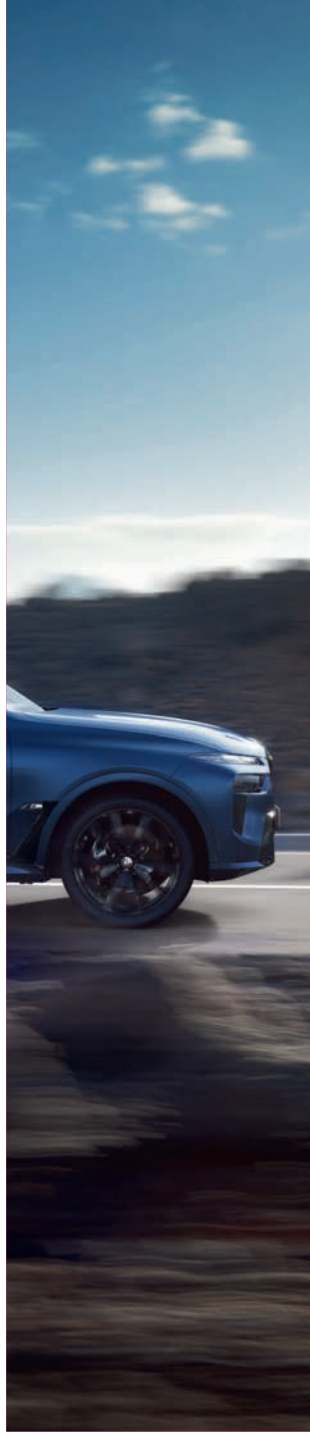
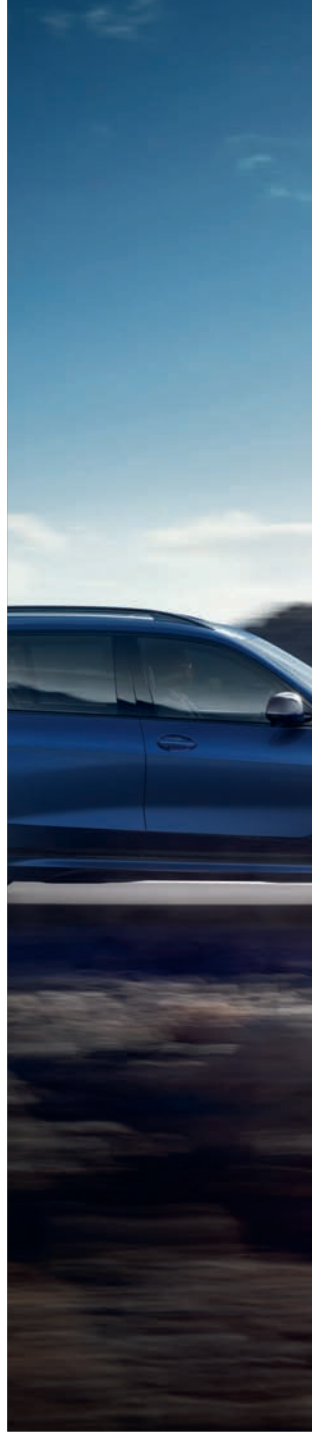

TECHNICAL VALUES  
AND SERVICES

# TECHNICAL VALUES.

		X7 xDrive40i <sup>4</sup>	X7 xDrive40d <sup>4</sup>
<b>Complete vehicle drive system<sup>2</sup></b>			
Drive system type		Petrol – 48-volt mild hybrid	Diesel – 48-volt mild hybrid
Power	kW (hp)	280 (381)	259 (352) <sup>5</sup>
Torque	Nm	540 <sup>5</sup>	720 <sup>5</sup>
Transmission		8-speed, automatic	8-speed, automatic
Drive type		All-wheel drive	All-wheel drive
<b>BMW TwinPower Turbo Motor<sup>2</sup></b>			
Cylinders		6	6
Capacity	cm <sup>3</sup>	2998	2993
Rated output	kW (hp)/rpm	280 (381)/5200–6250	250 (340)/4400
Rated torque	Nm/rpm	520/1850–5000	700/1750–2250
<b>Electric motor</b>			
(Rated) power	kW (hp)	9 (12)	9 (12)
(Rated) torque	Nm	200	200
<b>Driving performance</b>			
Acceleration 0–100 km/h	s	5.8	5.9
Top speed	km/h	250	245
<b>Consumption / CO<sub>2</sub> emissions<sup>2,3</sup></b>			
Fuel consumption, combined WLTP <sup>1,3</sup>	l/100 km	10.6–9.6	8.6–7.8
CO <sub>2</sub> emissions, combined WLTP	g/km	240–217	225–203
<b>48-volt battery</b>			
Battery size	kWh	0.46	0.46
<b>Dimensions / weights</b>			
Length / width / height	mm	5181 / 2000 / 1835	5181 / 2000 / 1835
Wheelbase	mm	3105	3105
Unladen weight <sup>1</sup>	kg	2490	2565
Luggage capacity	l	300–2120	300–2120
Fuel tank capacity	l	83	80
Trailer load optionally braked ex works up to 12% / trailer load	kg	3500 / 140	3500 / 140

The figures for performance, consumption and CO<sub>2</sub> emissions refer to vehicles with standard transmission.

<sup>1</sup> The EC unladen weight refers to a vehicle with standard equipment and does not include any optional equipment. The unladen weight includes a 90% full tank and a driver weight of 75 kg. Optional equipment may affect the weight of the vehicle, the payload and the top speed if the selected equipment has an impact on the vehicle's aerodynamics.

<sup>2</sup> Performance data of petrol engines applies to vehicles using RON 98 grade fuel. Fuel consumption data applies to vehicles using reference fuels in accordance with EU Regulation 2007/715. Unleaded RON 91 fuel and higher with a maximum ethanol content of 10% (E10) may also be used. BMW recommends RON 95 unleaded premium grade fuel.

<sup>3</sup> Official data for fuel consumption, CO<sub>2</sub> emissions, power consumption and electric range was determined in accordance with the prescribed measuring procedure and corresponds to European Regulation (EC) 715/2007 in the applicable version. For ranges, data determined as per WLTP takes into account any optional equipment (available on the German market in this case). For vehicles that have been newly type approved since 1 January 2021, only the official data according to WLTP exists. For more information about NEDC and WLTP measuring procedures visit [www.bmw.com/wltp](http://www.bmw.com/wltp)

<sup>4</sup> This engine version is not available in all countries. For further information, please contact your local BMW authorised workshop.

<sup>5</sup> Comprises engine driven (specified nominal value) and electric drive (up to specified nominal value).



# TECHNICAL VALUES.

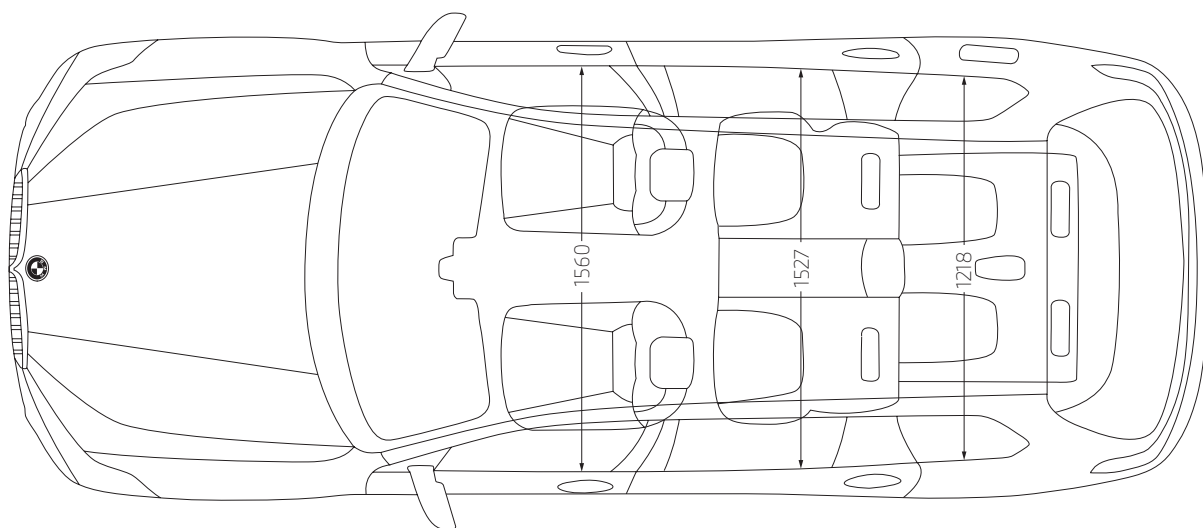
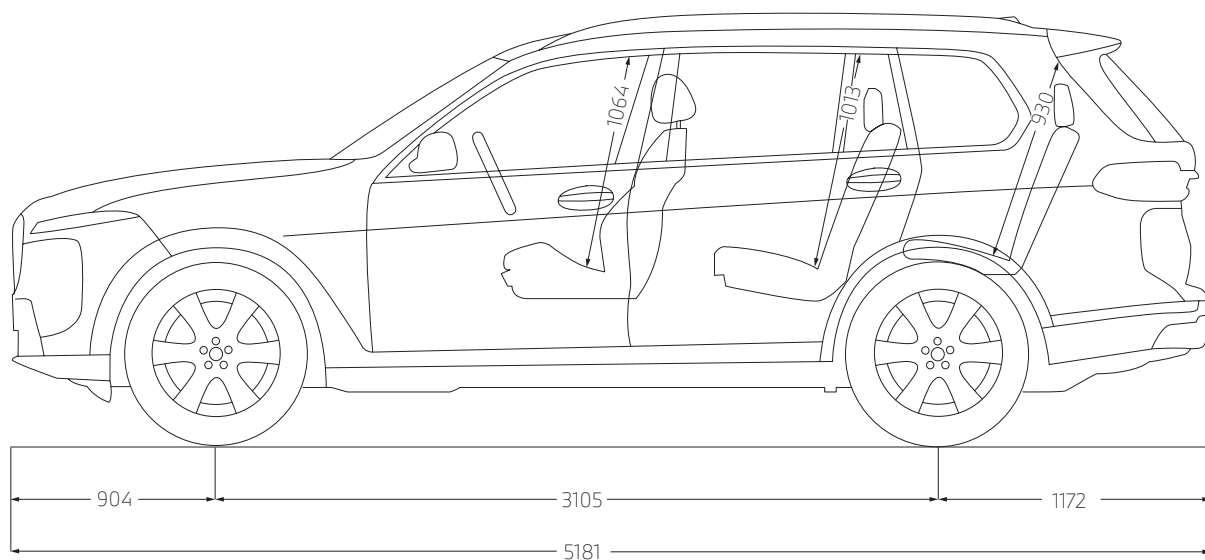
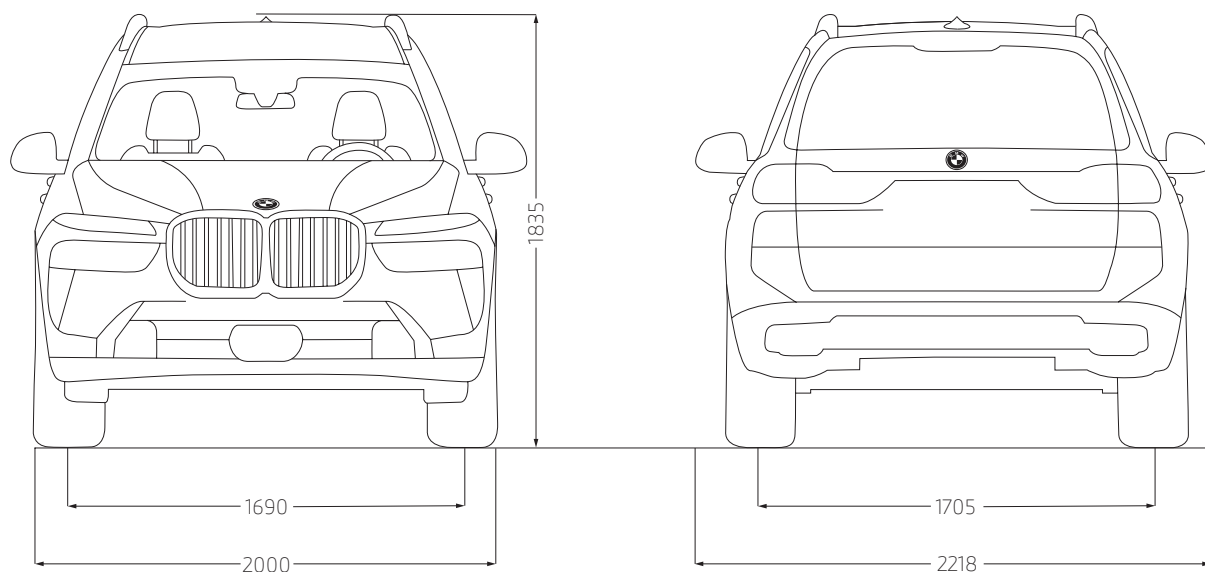

# TECHNICAL VALUES. M VEHICLE.

## X7 M60i xDrive<sup>4</sup>

<b>wheelbase<sup>2</sup></b>		
Drive system type		Petrol – 48-volt mild hybrid
Power	kW (hp)	390 (530)
Torque	Nm	750
Transmission		8-speed, automatic
Drive type		All-wheel drive
<b>BMW TwinPower Turbo engine<sup>2</sup></b>		
Cylinders		8
Capacity	cm <sup>3</sup>	4395
Rated output	kW (hp)/rpm	390 (530)/5500–6000
Rated torque	Nm/rpm	750/1800–4600
<b>Electric motor</b>		
(Rated) power	kW (hp)	9 (12)
(Rated) torque	Nm	200
<b>Driving performance</b>		
Acceleration 0–100 km/h	s	4.7
Top speed	km/h	250
<b>Consumption / CO<sub>2</sub> emissions<sup>2,3</sup></b>		
Fuel consumption, combined WLTP <sup>1,3</sup>	l/100 km	12.9–12.1
CO <sub>2</sub> emissions, combined WLTP	g/km	292–273
<b>48-volt battery</b>		
Battery size	kWh	0.46
<b>Dimensions / weights</b>		
Length / width / height	mm	5181 / 2000 / 1835
Wheelbase	mm	3105
Unladen weight <sup>1</sup>	kg	2675
Luggage capacity	l	300–2120
Fuel tank capacity	l	83
Trailer load optionally braked ex works up to 12% / trailer load	kg	3500 / 140

The figures for performance, consumption and CO<sub>2</sub> emissions refer to vehicles with standard transmission.

<sup>1</sup> The EC unladen weight refers to a vehicle with standard equipment and does not include any optional equipment. The unladen weight includes a 90% full tank and a driver weight of 75 kg. Optional equipment may affect the weight of the vehicle, the payload and the top speed if the selected equipment has an impact on the vehicle's aerodynamics.

<sup>2</sup> Performance data of petrol engines applies to vehicles using RON 98 grade fuel. Fuel consumption data applies to vehicles using reference fuels in accordance with EU Regulation 2007/715. Unleaded RON 91 fuel and higher with a maximum ethanol content of 10% (E10) may also be used. BMW recommends RON 95 unleaded premium grade fuel.

<sup>3</sup> Official data for fuel consumption, CO<sub>2</sub> emissions, power consumption and electric range was determined in accordance with the prescribed measuring procedure and corresponds to European Regulation (EC) 715/2007 in the applicable version. For ranges, data determined as per WLTP takes into account any optional equipment (available on the German market in this case). For vehicles that have been newly type approved since 1 January 2021, only the official data according to WLTP exists. For more information about NEDC and WLTP measuring procedures visit [www.bmw.com/wltp](http://www.bmw.com/wltp)

<sup>4</sup> This engine version is not available in all countries. For further information, please contact your local BMW authorised workshop.



# TECHNICAL VALUES. M VEHICLE.

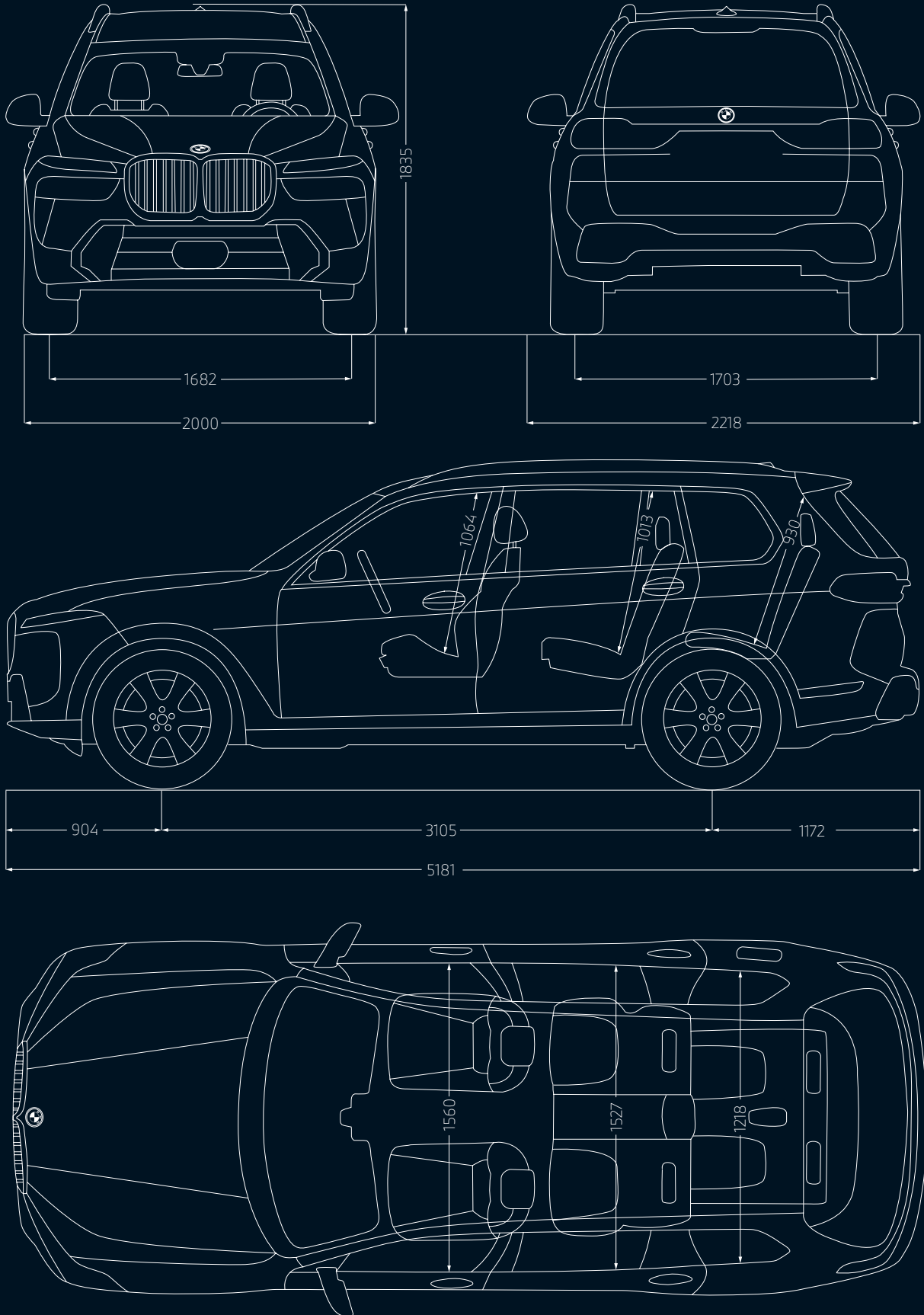

The dimensions in the technical drawing are in millimetres and may vary depending on the model and optional equipment.



## BMW SERVICE.



Always there for you: Your BMW Service Partner is there for helpful, expert support for everything to do with your BMW. Our aim is to make every journey in your BMW as pleasant as possible. A major worldwide network of workshops offers premium service from BMW specialists, innovative diagnostic technologies, and rapid availability of precisely fitting original BMW parts as well as original BMW engine oil. There are many great reasons to choose services from BMW, but there's one that really stands out: that driving pleasure that sets your BMW apart from the crowd will be yours to enjoy for many years to come with BMW Service.

## WHEREVER, WHENEVER: OUR COMPREHENSIVE SERVICE.

Many BMW services can be easily booked and tracked online – so you can use your time for the really important things in life. Stay independent and flexible with online appointments and remote services. Take advantage of our innovative digital products and services such as online video advice, and get all the relevant information on your smartphone. And if you don't want to stop but have no choice, our BMW Breakdown and Accident Assistance service will help.





---

## BMW SERVICE INCLUSIVE.

Just let go and concentrate only on what really counts: the joy of driving. You can do precisely that with BMW Service Inclusive because, with just one payment, you're covered for all included service and maintenance work for a duration of your choice, and can drive worry-free and without any hidden costs. Your BMW is always in the best hands – at all participating BMW service partners worldwide.



---

## BMW WARRANTY EXTENSION.

With the BMW dealer warranty, you are protected against unexpected repair costs for 24 months. But you'll have no need to worry even after then due to the option of extending your warranty to up to 5 years.

---

## MY BMW APP.

With the My BMW app, the digital world of BMW is always easily within reach on your smartphone. It offers a wide range of services and functions that make your life easier – before, during and after every journey. For example, the My BMW App notifies you when your BMW needs a service and offers an easy way to arrange a service appointment with your BMW Service Partner; just one more reason to enjoy the pleasure of driving.





---

# SUSTAINABILITY.



The BMW Group has been finishing at the top end of independent ratings and rankings that assess sustainability for a long time. These successes and increasing challenges in protecting the world we live in encourage us to embed sustainability as a key aspect in our corporate strategy. The development of efficient vehicle concepts, the establishment of eco-friendly production processes and the implementation of sustainable processes at our suppliers is part of our philosophy. Efficiency-enhancing technologies such as BMW EfficientDynamics and consistent electrification have enabled us to cut the CO<sub>2</sub> emissions of our

fleet of vehicles in Europe by 50% between 1995 and 2020. In addition, between 2006 and 2020 we have reduced the consumption of water by 31% and the consumption of energy in production by 38%. Our plants worldwide use green electricity only. As of 2021 our plants have even been producing completely carbon neutrally. And, of course, each of our vehicles is designed for easy or economical recycling after its long-running life. Please contact your BMW partner on all matters regarding your end-of-life vehicle. For more information on this issue please visit our website.





# YOUR WORLD. MY BMW.



This feature is only available in conjunction with ConnectedDrive Services and a compatible smartphone. The availability and functions of the My BMW App depend on the vehicle model and may vary depending on the market.



The direct connection to your vehicle and the world of BMW: Conveniently check the vehicle status with the new My BMW App, access functions remotely, make a service appointment, plan trips and much more – this way, the app becomes your daily mobility companion.

Try it out for yourself and install the My BMW App from your Google play or App Store.

