



THE 3

TOURING

YOUR WORLD. MY BMW.



This feature is only available in conjunction with ConnectedDrive Services and a compatible smartphone. The availability and functions of the My BMW App depend on the vehicle model and may vary depending on the market.



The direct connection to your vehicle and the world of BMW: Conveniently check the vehicle status with the new My BMW App, access functions remotely, make a service appointment, plan trips and much more – this way, the app becomes your daily mobility companion.

Try it out for yourself and install the My BMW App from your Google play or App Store.



**Highlights**

- Exterior design
- Interior design
- Driving dynamics
- Connectivity and infotainment
- Charging

Vehicle types**Models & packages**

- Base
- Plug-in hybrid
- M Sport package
- M Vehicles

Equipment

Equipment highlights
Wheels and tyres
Exterior colour world
Interior colour world
Genuine BMW Accessories

Technical values**BMW Services****BMW 330e:**

18-inch M light-alloy wheels Double-spoke style 848 M Bicolour with mixed tyres, exterior colour: BMW Individual Tanzanite Blue metallic, Vernasca leather MAOI Oyster decorative stitching, interior colour Black, BMW Individual interior trim in high-gloss aluminium fabric with accent strip in Pearl Chrome.

Fuel consumption in l/100 km (combined): 1.9–1.4
Power consumption in kWh/100 km (combined): 23.9–20.5
CO₂ emissions in g/km (combined): 42–31

BMW M340i xDrive:

19" M light alloy wheels Double-spoke style 792 M Bicolour Jet Black with sport tyres and mixed tyres, exterior colour: BMW Individual Frozen Tanzanite Blue metallic, Vernasca leather MANL Black contrasting stitching in blue, interior colour Black, Carbon Fibre M interior trim with Pearl Chrome trim.

Fuel consumption in l/100 km (combined): 8.8–8.1
CO₂ emissions in g/km (combined): 197–182

BMW 330i:

18-inch light-alloy wheels V-spoke style 780 Bicolour, exterior colour metallic A96 Mineral white, Sensatec perforated KHSW Black, Mesheffect aluminium interior trim

Fuel consumption in l/100 km (combined): 7.6–6.8
CO₂ emissions in g/km (combined): 172–154

At temperatures below freezing, the electric drive system on this plugin hybrid is only available after a few kilometres of driving, once the battery has heated to operational temperature.

The models illustrated in this medium show the equipment and configuration options (standard and optional) for vehicles produced by BMW AG for the German market. Alterations in standard and optional equipment and the configurations available for the different models, as described in this brochure, may occur after 05/02/2022, the date when this brochure went to press. Your local BMW Partner is available to provide further details. Subject to change in design and equipment.

Descriptions and illustrations include optional equipment



NEW
GENERATION JOY.



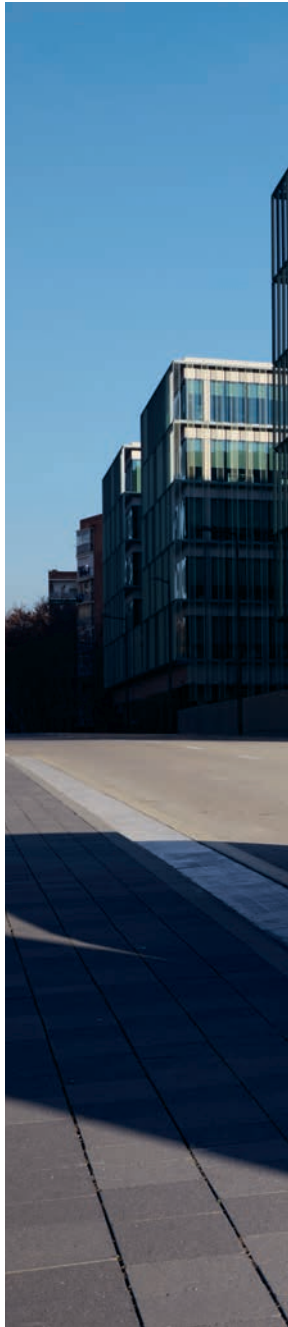

Descriptions and illustrations include optional equipment



EXPERIENCE JOY.

Precision meets expressive power: the BMW 3 Series Touring fascinates with its dynamic presence and stands for a new era of unbridled energy. Its wide, sporty kidney grille matches the harmonious contours of the headlights perfectly. The striking wheel design underlines the inverted L shape of the daytime driving lights, which are impressively showcased and perfect the energetic appearance.



UNCOMPROMISINGLY
DYNAMIC.

Descriptions and illustrations include optional equipment



Built to impress: the BMW 3 Series Touring impresses with the line of the roof and side window graphics, which, together with the powerful shoulder area, demonstrate pure forward thrust. The Hofmeister kink gives the side section an even more athletic look. The striking rear end is characterised by its sporty proportions and surfaces in Black high-gloss. The BMW 3 Series Touring offers generous space for you and more space for adventure.

SPACIOUS INTERIOR.

Functionality paired with comfort: the BMW 3 Series Touring is the perfect trailblazer for your next adventure. The interior not only offers generous space, but also ensures a high degree of flexibility with the luggage compartment. Two beverages can be safely stored in the cupholders with clamping elements integrated into the centre console in front of the gear lever. Thanks to its numerous colour variants, the perforated Sensatec leaves nothing to be desired and turns the interior into a special experience.





Descriptions and illustrations include optional equipment

FASCINATION: INNOVATION.





Exceptionally forward-looking: the BMW 3 Series Touring impresses with its generous BMW Curved display. The multisensory vehicle experience of the BMW iDrive with the latest generation of the BMW Operating System 8 lends the BMW 3 Series Touring a high-quality and highly innovative look. The BMW Intelligent Personal Assistant is your personal vehicle expert with whom you can operate many vehicle functions via voice control.

A silver car is shown in motion, driving through a tunnel. The background is heavily blurred, conveying a sense of speed. The car is positioned on the right side of the frame, moving towards the left. The lighting is dim, typical of an underground tunnel, with some light reflecting off the car's surface.

VERSATILE
ON THE MOVE.

Descriptions and illustrations include optional equipment



Efficient plug-in hybrid, powerful diesel or petrol engine: the BMW 3 Series Touring impresses in every version with its unique performance. Thanks to BMW xDrive, you also enjoy added traction, driving dynamics and driving safety.



Descriptions and illustrations include optional equipment



PURE
DRIVING JOY.





JOY CONNECTS.

Well connected: state-of-the-art technologies such as the innovative BMW iDrive make your BMW 3 Series Touring a mobile entertainer. Connected Music with Spotify means your favourite tracks are always with you. Thanks to BMW Intelligent Personal Assistant, you can operate many vehicle functions via voice control. The M leather steering wheel with multifunction buttons and steering wheel rim in Black 'Walknappa' leather offers an ideal feel and sporty look for a dynamic driving experience.



Descriptions and illustrations include optional equipment



Perfectly prepared: the BMW 3 Series Touring gets you to your destinations safely and in a good mood. With sophisticated driver assistance systems and a chassis and suspension setup that is ready to break new ground.

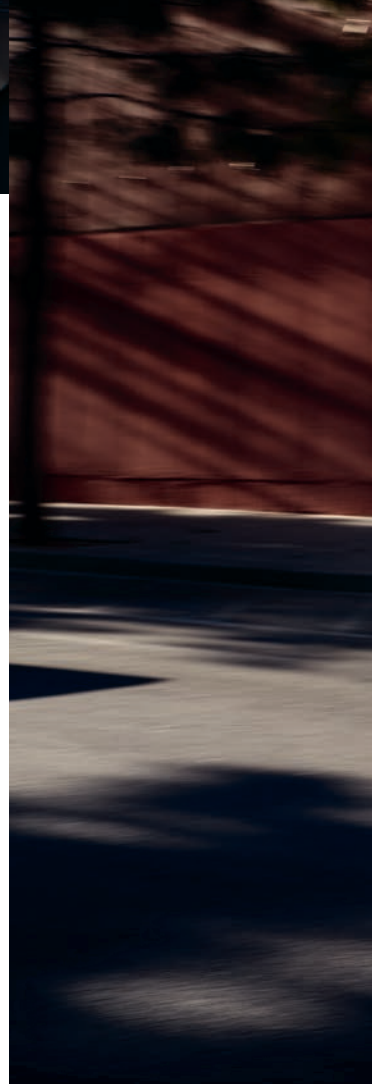



ENJOY THE DRIVE
WITH SAFETY.



Descriptions and illustrations include optional equipment



With BMW Charging, you can quickly recharge your batteries. Whether at home or on the road, the basic equipment for convenient charging is already included in the BMW 3 Series Touring. For the greatest convenience in every charging situation.



ANTICIPATION
RELOADED.

Descriptions and illustrations include optional equipment



CONVINCING
ACROSS THE BOARD.





MODEL VARIANTS AT A GLANCE.

BASIC VERSION

Unlimited driving pleasure. The BMW 3 Series Touring.



M SPORT PACKAGE



Uncompromisingly dynamic. The BMW 3 Series Touring with M Sport package.

BMW PLUGIN HYBRID



Double the energy. the BMW 3 Series Touring as a plug-in hybrid.

M VEHICLES



Unbridled model athlete. The BMW 3 Series Touring M Performance.

The availability of some equipment features, functions and digital services depends on engine versions or additional optional equipment. The offer structure as well as market and production availability may vary. For detailed information about availabilities, duration and costs, contact your local BMW authorised workshop.

MODEL VARIANTS AT A GLANCE.

	318i	320i	330i	330i xDrive
Transmission	8-speed, automatic	8-speed, automatic	8-speed, automatic	8-speed, automatic
Cylinders/displacement, quantity/cm ³	4/1998	4/1998	4/1998	4/1998
Nominal power kW (hp)	115 (156)	135 (184)	180 (245)	180 (245)

	318d³	320d³	320d xDrive³	330d³	330d xDrive³
Transmission	8-speed, automatic	8-speed, automatic	8-speed, automatic	8-speed, automatic	8-speed, automatic
Cylinders/displacement, quantity/cm ³	4/1995	4/1995	4/1995	6/2993	6/2993
Nominal power kW (hp)	110 (150)	140 (190)	140 (190)	210 (286)	210 (286)

BMW PLUGIN HYBRID

	320e	320e xDrive	330e	330e xDrive
Transmission	8-speed, automatic	8-speed, automatic	8-speed, automatic	8-speed, automatic
Cylinders/displacement, quantity/cm ³	4/1998	4/1998	4/1998	4/1998
Nominal power kW (hp)	150 (204) ^{1,2}	150 (204) ^{1,2}	215 (292) ^{1,2}	215 (292) ^{1,2}

BMW M VEHICLES

	M340i xDrive³	M340d xDrive³
Transmission	8-speed, automatic	8-speed, automatic
Cylinders/displacement, quantity/cm ³	6/2998	6/2993
Nominal power kW (hp)	275 (374)	250 (340)

¹ Comprises engine driven (specified nominal value) and electric drive (up to specified nominal value).

² Power depends on the battery charge.

³ This engine version is not available in all countries. For further information, please contact your local BMW authorised workshop.

The availability of some equipment features, functions and digital services depends on engine versions or additional optional equipment. The offer structure as well as market and production availability may vary. For detailed information about availabilities, duration and costs, contact your local BMW authorised workshop.

SELECTED STANDARD EQUIPMENT.

You will find **selected standard equipment** for your vehicle here.

EXTERIOR

Exterior items

M High-gloss Shadowline exterior trim

For an even sportier appearance, the M High-gloss Shadowline exterior trim features numerous exterior design details of your BMW in high-gloss Black.

M roof rails high-gloss Shadow Line

The exclusive M roof rails high-gloss Shadow Line form the basis for roof rack unit in order to be able to e.g., transport a roof box or bicycles.

LED headlights

The LED headlights increase safety at night with outstanding illumination. Eye-catcher: the inverted L-shape of the daytime driving lights.

Rear lights with LED technology

The rear lights with their characteristic L-shape and lighting elements in full LED technology identify the vehicle as a BMW even in the dark.

Welcome Light

For even more comfort in everyday life, the Welcome light switches on the interior lighting as soon as you open your BMW using the vehicle key.

17" light alloy wheels V-spoke style 778

17" light alloy wheels V-spoke style 778 Reflex Silver, wheel size 7.5J x 17 with 225/50 R17 tyres.

INTERIOR

Hevelius fabric

Cloth 'Hevelius' EHAT Anthracite

Interior trim finishers Quartz Silver matt, grained

Floor mats in velour

The floor mats in velour for the front and rear footwells match the carpet colour, fit perfectly and repel dirt and water.

Interior lighting

From reading lights to illuminated stowage facilities: the interior lighting comprises many practically positioned lights in the interior.

Sport leather steering wheel

The black Sport leather steering wheel with a thick rim and contoured thumb rests has an exceptionally pleasant, high-grip feel.

DRIVER ASSISTANCE AND SAFETY

Three-point seat belts

Acoustic protection for pedestrians

Acoustic pedestrian protection generates an artificial driving noise. This is how your BMW draws the attention of other road users.

Rear-view mirror with automatic anti-dazzle function

The interior rear-view mirror with automatic anti-dazzle function reduces unpleasant glare caused by the headlights of vehicles behind.

Cruise Control with brake function

The Cruise Control with brake function stores and maintains any selected speed above 30 km/h, even when going downhill.

Park Distance Control (PDC)

Front and rear Park Distance Control (PDC) makes parking and manoeuvring in tight spaces much easier.

Speed limiter

With the Manual Speed Limiter, you can adopt a current speed as the maximum speed. All you need to do is tap the button on the steering wheel.

Attentiveness Assistant

The Attentiveness Assistant checks your steering behaviour for signs of fatigue and recommends that you take a break if necessary.

Side impact protection

Side impact protection increases safety in your BMW. In a collision, passive and active protective functions work together as one unit.

Crash Sensor

In the event of an accident, the crash sensor activates various useful functions to increase safety and make rescue operations easier.

The availability of some equipment features, functions and digital services depends on engine versions or additional optional equipment. The offer structure as well as market and production availability may vary. For detailed information about availabilities, duration and costs, contact your local BMW authorised workshop.

SELECTED STANDARD EQUIPMENT.

You will find **selected standard equipment** for your vehicle here.

CONNECTIVITY AND INFOTAINMENT

BMW Live Cockpit Plus

The BMW Live Cockpit Plus offers practical functions including navigation, intuitive operating options and a large curved display.

BMW Curved Display

The one-piece BMW Curved Display is intuitive to operate and combines a 12.3" instrument display with a 14.9" control display.

DRIVING DYNAMICS

Steptronic transmission with gearshift paddles

The 8-speed Steptronic transmission offers you a high level of shifting and driving comfort. In addition, in M mode you can shift completely manually using the shift paddles.

Standard suspension

The Standard suspension offers a high level of precision, agility and suspension comfort. The prerequisites for this are an ideally matched two-joint spring strut front axle made of aluminium and an elaborately designed five-link rear axle.

Driving Experience Control

Driving Experience Control gives you the choice between comfortable, particularly economical or emphatically sporty driving.

COMFORT AND FUNCTIONALITY

Rear-seat headrests, folding

Folding headrests for the three rear seats improve the view through the rear window.

Armrest

Multifunction buttons on the steering wheel

Heat protection / sun protection glazing

With heat/sun protection glazing on the side and rear windows, the interior of your BMW heats up less on sunny days. It is slightly tinted, reflecting part of the incident infrared radiation.

Automatic air conditioning

Standard automatic air conditioning with 3-zone control includes Automatic Air Recirculation (AAR) with a micro active carbon filter, as well as fogging and solar sensors.

Storage compartment package

The practical extended storage offers additional options for stowing items in your BMW. Also included: two USB ports.

Cupholder

Two beverages can be safely stored in the cupholders with clamping elements integrated into the centre console in front of the gear lever.

Window lifts, electrical

Windscreen wipers with integrated washing nozzles

Sun visors

Through-loading system

The through-loading system with rear seat backrests, which are divisible in a 40:20:40 ratio, guarantees flexibility when transporting people and objects.

The availability of some equipment features, functions and digital services depends on engine versions or additional optional equipment. The offer structure as well as market and production availability may vary. For detailed information about availabilities, duration and costs, contact your local BMW authorised workshop.

BASIC VERSION.

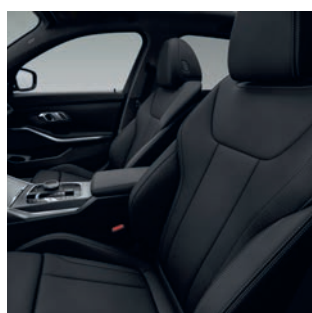

The front standard seats already provide a great deal of comfort. The seat height, fore/aft position, backrest angle and head restraint height can be adjusted manually.



The black Sport leather steering wheel with a thick rim and contoured thumb rests has an exceptionally pleasant, high-grip feel.



17" light alloy wheels V-spoke style 778 Reflex Silver, wheel size 7.5J x 17 with 225/50 R17 tyres.



BASIC EXTERIOR EQUIPMENT FEATURES:

- M High-gloss Shadowline incl. roof rails
- LED headlights and LED rear lights
- Automatic tailgate operation
- Light alloy wheels
- Rear window, opening separately

BASIC INTERIOR EQUIPMENT FEATURES:

- BMW Live Cockpit Plus with BMW Curved Display
- BMW Operating System 8 with navigation
- Sport leather steering wheel
- Automatic air conditioning with 3-zone control
- Through-loading system 40:20:40

The availability of some equipment features, functions and digital services depends on engine versions or additional optional equipment. The offer structure as well as market and production availability may vary. For detailed information about availabilities, duration and costs, contact your local BMW authorised workshop.

BMW PLUG-IN HYBRID.



The front standard seats already provide a great deal of comfort. The seat height, fore/aft position, backrest angle and head restraint height can be adjusted manually.



The black Sport leather steering wheel with a thick rim and contoured thumb rests has an exceptionally pleasant, high-grip feel.



17" light alloy wheels V-spoke style 778 Reflex Silver, wheel size 7.5J x 17 with 225/50 R17 tyres.



With the standard charging cable (mode 2) for domestic socket outlets, you can conveniently charge your BMW's high-voltage battery at domestic sockets.

PLUG-IN HYBRID EXTERIOR EQUIPMENT FEATURES:

- M High-gloss Shadowline incl. roof rails
- LED headlights and LED rear lights
- Automatic tailgate operation
- Light alloy wheels
- Rear window, opening separately

PLUG-IN HYBRID INTERIOR EQUIPMENT FEATURES:

- BMW Live Cockpit Plus with BMW Curved Display
- BMW Operating System 8 with navigation
- Sport leather steering wheel
- Automatic air conditioning with 3-zone control
- Through-loading system 40:20:40

The availability of some equipment features, functions and digital services depends on engine versions or additional optional equipment. The offer structure as well as market and production availability may vary. For detailed information about availabilities, duration and costs, contact your local BMW authorised workshop.

M SPORT PACKAGE.



Thanks to numerous adjustment options as well as raised seat and backrest bolsters, the Sport seats offer optimum lateral support for the two front seats.

The M leather steering wheel with multifunction buttons and steering wheel rim in Black 'Walknappa' leather offers an ideal feel and sporty look for a dynamic driving experience.

18" M light alloy wheels Double-spoke style 848 M Bicolour Jet Black with mixed tyres, gloss-lathed, wheel size front 7.5J x 18 with 225/45 R18 tyres, wheel size rear 8.5J x 18 with 255/40 R18 tyres.



M SPORT PACKAGE EXTERIOR EQUIPMENT:

- M Aerodynamics package with front apron, side sills and rear apron in the vehicle colour with diffuser insert in Black high-gloss
- BMW kidney grille with exclusively designed longitudinal struts in Silver matt and kidney grille frame in Pearl Chrome, alternatively BMW kidney grille frame in Black high-gloss
- 18" M light alloy wheels Double-spoke style 848 M Bicolour Jet Black with mixed tyres, other wheels also available
- M Sport suspension incl. variable sport steering; other suspension available
- M High-gloss Shadowline exterior trim, alternatively Exterior Line Satin Aluminium
- M designation on the sides
- Exterior mirror caps in body colour, alternatively in high-gloss Black
- M roof rails high-gloss Shadowline
- Tailpipe trim in Chrome high-gloss, alternatively in Black high-gloss
- Exclusive M Portimao Blue metallic and M Brooklyn Grey metallic paintwork; other paintwork available

M SPORT PACKAGE INTERIOR EQUIPMENT:

- M entry sills
- M driver footrest and M pedals
- Sport seats for driver and front passenger in Alcantara/Sensatec combination with perforation and contrast stitching in Blue, alternatively leather 'Vernasca' Black with contrast stitching in Blue incl. instrument panel in Sensatec with exclusive blue stitching; other upholsteries available
- M Leather steering wheel
- Car key with exclusive M designation
- M anthracite headliner
- Instrument cluster with M specific display
- Aluminium Rhombic Anthracite M interior trim strips, alternatively Carbon Fibre M interior trim; further trims available

The availability of some equipment features, functions and digital services depends on engine versions or additional optional equipment. The offer structure as well as market and production availability may vary. For detailed information about availabilities, duration and costs, contact your local BMW authorised workshop.

M VEHICLES.

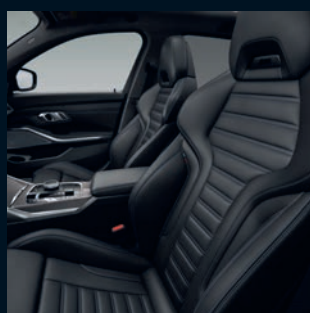

Thanks to numerous adjustment options as well as raised seat and backrest bolsters, the Sport seats offer optimum lateral support for the two front seats.

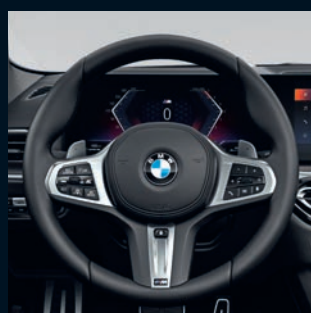

The M leather steering wheel with multifunction buttons and steering wheel rim in Black 'Walknappa' leather offers an ideal feel and sporty look for a dynamic driving experience.



19" M light alloy wheels Double-spoke style 792 M Bicolour Jet Black with mixed tyres and runflat tyres, gloss-lathed, front 8J x 19 with 225/40 R19 tyres, rear 8.5J x 19 with 255/35 R19 tyres.¹



The high-performance M Sport braking system¹ is distinguished by exclusive brake callipers in Red high-gloss with M inscription and outstanding braking performance.

SELECTED M VEHICLE EXTERIOR EQUIPMENT FEATURES:

- M Aerodynamics package
- M exterior mirrors
- M high-gloss Shadow Line incl. roof rails
- LED headlights and LED rear lights
- Automatic tailgate operation
- M light alloy wheels
- Rear window, opening separately

SELECTED M VEHICLE INTERIOR EQUIPMENT FEATURES:

- BMW Live Cockpit Plus with BMW Curved Display
- BMW Operating System 8 with navigation
- Sport seats
- HiFi loudspeaker system
- M leather steering wheel
- Automatic air conditioning with 3-zone control
- Through-loading system 40:20:40

¹ Optionally available.

The availability of some equipment features, functions and digital services depends on engine versions or additional optional equipment. The offer structure as well as market and production availability may vary. For detailed information about availabilities, duration and costs, contact your local BMW authorised workshop.

INNOVATION PACKAGE.

The Innovation package includes all the features of the standard equipment and offers additional exclusive optional equipment that makes driving the new BMW 3 Series Touring a special experience.



BMW Live Cockpit Professional with its large curved display expands BMW Live Cockpit Plus with a full-colour head-up display. This projects driving information such as speed or navigation instructions directly into the field of vision – for a better overview and more safety.

Parking Assistant¹ makes parking easier with features including the Reversing Assist Camera, the Active Park Distance Control as well as the Parking and Reversing Assistant.



Interior and driver's side exterior mirror with automatic anti-dazzle function, including electric fold-in function for the exterior mirrors and automatic parking function for the front passenger exterior mirror.



¹ The driver is responsible for constantly monitoring the automated parking manoeuvre in accordance with local road traffic regulations.

The availability of some equipment features, functions and digital services depends on engine versions or additional optional equipment. The offer structure as well as market and production availability may vary. For detailed information about availabilities, duration and costs, contact your local BMW authorised workshop.



EQUIPMENT HIGHLIGHTS.

Discover select standard and optional equipment highlights. Optional equipment shown is not included in the basic price.



M Sport suspension¹ – which includes a suspension which is lowered by 10 millimetres – is characterised by more athletic suspension settings with tighter damper settings. It also features a moderately higher spring constant and harder stabilisers. Combined together, they result in an even more direct suspension design, which enables a distinctly sporty driving style.

The 10 millimetre lowered adaptive M suspension^{1,2} can be electrically adjusted at any time to suit the road and driving conditions. Drivers can also adjust the suspension characteristics via the Driving Experience Control to enable their preferred driving style at the time – from comfortable to extremely athletic with markedly agile handling.



The highperformance M Sport braking system is distinguished by exclusive brake calipers in Red Highloss³ with M inscription and outstanding braking performance.



Mild hybrid technology saves fuel by recovering braking energy and supports the combustion engine during acceleration.

¹ Only available in conjunction with variable sport steering.

² The lowering of the chassis does not apply to plugin hybrid models.

³ Also available in blue.

The availability of some equipment features, functions and digital services depends on engine versions or additional optional equipment. The offer structure as well as market and production availability may vary. For detailed information about availabilities, duration and costs, contact your local BMW authorised workshop.

EQUIPMENT HIGHLIGHTS.

Discover select standard and optional equipment highlights. Optional equipment shown is not included in the basic price.



BMW Live Cockpit Professional with its large curved display expands BMW Live Cockpit Plus with a full-colour head-up display. This projects driving information such as speed or navigation instructions directly into the field of vision – for a better overview and more safety.



Whether navigation or smartphone integration¹ – the digital services of the Connected Package Professional² leave nothing to be desired.



The wireless charging tray conveniently charges your smartphone without cables at up to 15 W of power. Integrated cooling protects against overheating.

With the Personal eSIM³, you can use your mobile communications contract for your BMW. Advantages: simplified operation, improved reception, 5G mobile access.



16 speakers, 464 W digital amplifier, nine channels: the Harman Kardon surround sound system allows you to enjoy a thrilling sound experience.

For brilliant acoustics in all seats, the HiFi loudspeaker system distributes the sound evenly throughout the interior via ten speakers.

¹ Smartphone integration is not compatible with all smartphones and apps.

² Smartphone integration is permanently available in the vehicle. The online functions for Maps Connected Navigation each have a three year term. These can be extended at the end of the term in the BMW ConnectedDrive Store. To use optional equipment other optional equipment may be necessary. Due to possible future technical developments (e.g. of mobile phones), the usability of the Apple CarPlay or the Google Android Auto services cannot be guaranteed in the long term. CarPlay is a trademark of Apple Inc. Android Auto is a trademark of Google LLC.

³ This service only works with an existing mobile communications contract between the customer and their mobile communications provider that includes the eSIM and 5G option. Customers can check the availability of the eSIM contract option with their mobile communications provider.

The availability of some equipment features, functions and digital services depends on engine versions or additional optional equipment. The offer structure as well as market and production availability may vary. For detailed information about availabilities, duration and costs, contact your local BMW authorised workshop.

EQUIPMENT HIGHLIGHTS.

Discover select standard and optional equipment highlights. Optional equipment shown is not included in the basic price.



Active Protection preventive occupant protection takes numerous measures to ensure that you and your passengers are safe in the event of a possible collision. It pretensions the seat belts, brings electric seats into an upright position and closes the windows and the slide/tilt sunroof.



Distance Control increases comfort and active safety. Between 30 and 160 km/h, it controls the distance to the vehicle ahead, including stopping and moving off again with Stop&Go. Speed Limit Assist makes it possible for speed limits to be transferred to the cruise control. The Front Collision Warning with brake intervention reacts to stationary obstacles.



The Parking Assistant¹ makes parking the vehicle easier. The Reversing Assist Camera and Reversing Assistant support the driver when reversing. Active Park Distance Control offers increased protection against damage caused by parking. Park Assist parks the vehicle automatically, parallel or perpendicular to the street, and leaves parallel parking spaces.

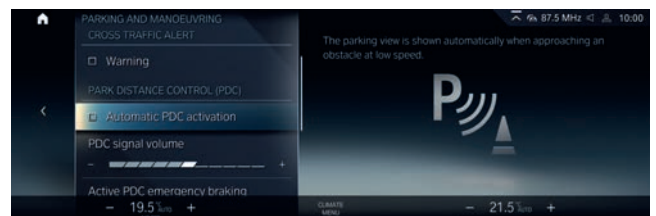

The Parking Assistant Plus¹ makes parking and manoeuvring the vehicle easier. The equipment features among others the Surround View system including Top View, Panorama View, Remote 3D View, as well as a lateral parking aid, the emergency braking function Active Park Distance Control, Park Assist with longitudinal and lateral guidance and Reversing Assistant.

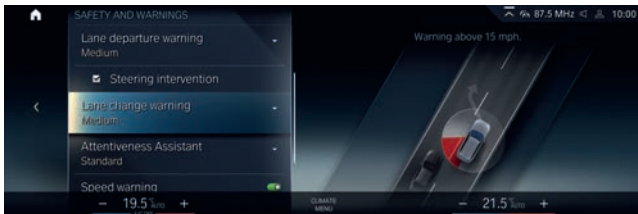

The Driving Assistant² provides support in critical driving situations. If necessary, the safety package brakes automatically to prevent rear-end collisions. It also warns of unintentional lane departure and actively guides your BMW back into its lane. If a rear-end collision appears to be imminent, it initiates protective measures and also draws attention to excessive speed.

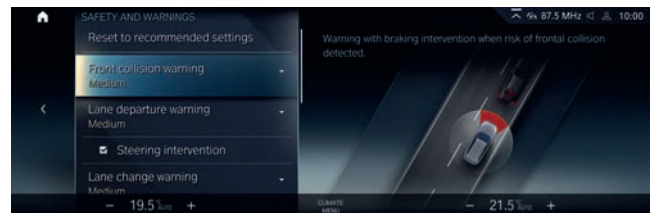

A real all-rounder: The Driving Assistant Professional² not only maintains the desired speed and distance to the vehicle in front, but also keeps your BMW on track by steering interventions. This relieves the strain, especially on longer journeys. Other functions help you avoid collisions and exceeding the speed limit.

¹ The driver is responsible for constantly monitoring the automated parking procedure in accordance with local road laws.

² Function may be restricted in darkness, fog or bright glare.

The availability of some equipment features, functions and digital services depends on engine versions or additional optional equipment. The offer structure as well as market and production availability may vary. For detailed information about availabilities, duration and costs, contact your local BMW authorised workshop.

EQUIPMENT HIGHLIGHTS.

Discover select standard and optional equipment highlights. Optional equipment shown is not included in the basic price.



The electric lumbar support for the driver seat can be adjusted both vertically and laterally, allowing for an orthopaedically optimised seating position.



Folding headrests for the three rear seats improve the view through the rear window.



The Comfort Access makes it possible to open all of the vehicle doors without actively using the key and additionally includes BMW Digital Key.¹



The electric panoramic glass sunroof ensures a light-flooded interior and blends seamlessly into the dynamic vehicle design.



The electric seat adjustment for the two front seats with a memory function for the driver's seat and the exterior mirrors enhances comfort.

¹ BMW Digital Key is compatible with selected smartphones only. A list of compatible smartphones can be found at [bmw.com/digitalkey](https://www.bmw.com/digitalkey). The use of BMW Digital Key requires the Teleservices equipment.

The availability of some equipment features, functions and digital services depends on engine versions or additional optional equipment. The offer structure as well as market and production availability may vary. For detailed information about availabilities, duration and costs, contact your local BMW authorised workshop.

EQUIPMENT HIGHLIGHTS.

Discover select standard and optional equipment highlights. Optional equipment shown is not included in the basic price.



For optimal lateral support, you can adapt the driver's seat with integrated backrest width adjustment to suit your respective body dimensions.



The pre-heating¹ with timer function enables the interior to be temperature-controlled without having to start the engine beforehand.



In addition to the electric remote backrest unlocking, the luggage-compartment package also includes practical slide and anti-slip rails, depending on the engine version.²



The seat heating for driver and front passenger enables the entire seat, backrest and side bolster surface to be heated.



The steering wheel heating³ very quickly warms up the steering wheel rim at the push of a button – a feature that's particularly useful in winter.

¹ Only available in conjunction with BMW display key..

² The automated slide & anti-slip rails are not available for PHEV models.

³ Only available in conjunction with Sport leather steering wheel and M leather steering wheel.

The availability of some equipment features, functions and digital services depends on engine versions or additional optional equipment. The offer structure as well as market and production availability may vary. For detailed information about availabilities, duration and costs, contact your local BMW authorised workshop.

EQUIPMENT HIGHLIGHTS.

Discover select standard and optional equipment highlights. Optional equipment shown is not included in the basic price.



The Sensatec instrument panel refines the interior of your BMW. The black cover is complemented by visually attractive double fell seams.



Galvanic embellishers on operating elements such as the window lifter shimmer in the sunlight and create high-quality highlights in the interior.



BMW Individual interior trim finishers piano finish Black



For the M anthracite headliner, the headliner and the roof pillar trim panels are finished in Anthracite cloth for a sporty ambience.



Ambient light creates a relaxing atmosphere in the interior. On the outside, a light graphic lights up as a welcome and to say goodbye.

The availability of some equipment features, functions and digital services depends on engine versions or additional optional equipment. The offer structure as well as market and production availability may vary. For detailed information about availabilities, duration and costs, contact your local BMW authorised workshop.

EQUIPMENT HIGHLIGHTS.

Discover select standard and optional equipment highlights. Optional equipment shown is not included in the basic price.



The Roof rails in Aluminium satinated¹ provide the base for a multifunctional BMW roof rack unit.



For an even sportier appearance, the M High-gloss Shadowline exterior trim features numerous exterior design details of your BMW in high-gloss Black.



The respective logos of the M Sport package can be omitted upon request.



The Adaptive LED Headlights always provide optimum illumination. Eye-catcher: the blue staging and the inverted L-shape of the daytime driving lights.



The Exterior Line Satin Aluminium with stylish contrasts gives your BMW an elegant and luxurious look.

¹ Only available in conjunction with Exterior Line Satin Aluminium.

The availability of some equipment features, functions and digital services depends on engine versions or additional optional equipment. The offer structure as well as market and production availability may vary. For detailed information about availabilities, duration and costs, contact your local BMW authorised workshop.

EQUIPMENT HIGHLIGHTS. M VEHICLES.

Discover select standard and optional equipment highlights. Optional equipment shown is not included in the basic price.



The M Sport differential improves traction and driving stability, particularly when changing lanes, cornering or when there are changing road conditions.



The M high-gloss Shadowline exterior trim with extended elements complements the contents of the M High-gloss Shadow Line with a BMW kidney grille and tailpipe trims in Black.



The M seat belts with belt tensioner and belt force limiter boast an exquisite stitched highlight in the classic M colours.



The M lights Shadow Line¹ give your BMW an unmistakable look. Selected chrome trim elements of the main headlights are finished in Black.

The availability of some equipment features, functions and digital services depends on engine versions or additional optional equipment. The offer structure as well as market and production availability may vary. For detailed information about availabilities, duration and costs, contact your local BMW authorised workshop.

¹ Only available in conjunction with adaptive LED headlights.



WHEELS AND TYRES.

Discover select standard and optional equipment highlights. Optional equipment shown is not included in the basic price.



19" M light alloy wheels Double-spoke style 791 M Bicolour Jet Black with performance tyres and mixed tyres, gloss-lathed, front 8J x 19 with 225/40 R19 tyres, rear 8.5J x 19 with 255/35 R19 tyres.¹



19" M light alloy wheels Double-spoke style 791 M Jet Black uni with performance tyres and mixed tyres, wheel size front 8J x 19 with 225/40 R19 tyres, wheel size rear 8.5J x 19 with 255/35 R19 tyres.¹



19" BMW Individual light alloy wheels Double-spoke style 793 I Bicolour Orbit Grey with mixed tyres and run-flat tyres, gloss-lathed, wheel size front 8J x 19 with 225/40 R19 tyres, wheel size rear 8.5J x 19 with 255/35 R19 tyres.



19" M light alloy wheels Double-spoke style 792 M Bicolour Jet Black with mixed tyres and runflat tyres, gloss-lathed, front 8J x 19 with 225/40 R19 tyres, rear 8.5J x 19 with 255/35 R19 tyres.⁴

18" M light alloy wheels Double-spoke style 848 M Bicolour Jet Black with mixed tyres, gloss-lathed, wheel size front 7.5J x 18 with 225/45 R18 tyres, wheel size rear 8.5J x 18 with 255/40 R18 tyres.²

18" light alloy wheels Double-spoke style 782 Bicolour Jet Black, gloss-lathed, wheel size 7.5J x 18 with 225/45 R18 tyres.

18" light alloy wheels V-spoke style 780 Bicolour Orbit Grey with mixed tyres, gloss-lathed, wheel size front 7.5J x 18 with 225/45 R18 tyres, wheel size rear 8.5J x 18 with 255/40 R18 tyres.



17" light alloy wheels V-spoke style 778 Reflex Silver, wheel size 7.5J x 17 with 225/50 R17 tyres.



17" light alloy wheels V-spoke style 775 Reflex Silver, wheel size 7.5J x 17 with 225/50 R17 tyres.³



17" light alloy wheels V-spoke style 776 Ferric Grey, wheel size 7.5J x 17 with 225/50 R17 tyres.



17" light alloy wheels V-spoke style 775 Bicolour Orbit Grey, gloss-lathed, wheel size 7.5J x 17 with 225/50 R17 tyres.

¹ Only in conjunction with the M Sport package.

² Only in conjunction with the M Sport package. Standard equipment for M Vehicles.

³ Standard equipment.

⁴ Only available for M Vehicles.

The availability of some equipment features, functions and digital services depends on engine versions or additional optional equipment. The offer structure as well as market and production availability may vary. For detailed information about availabilities, duration and costs, contact your local BMW authorised workshop.

EXTERIOR COLOURS.

SOLID PAINT



Non-metallic 300 Alpine White



Non-metallic 668 Black

METALLIC

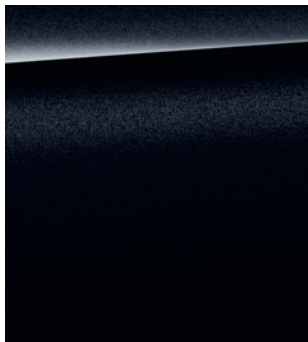

Metallic 475 Black Sapphire



Metallic A75 Melbourne Red



Metallic A96 Mineral White

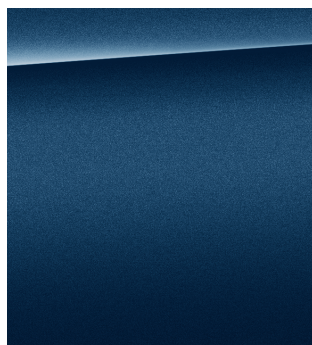

Metallic C1M Phytionic Blue



Metallic C31 M Portimao Blue¹

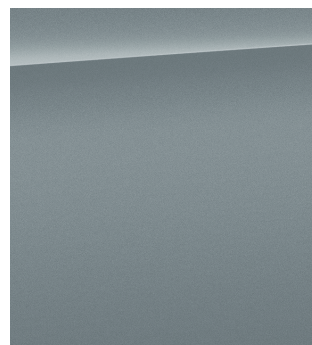

Metallic C4P M Brooklyn Grey¹

BMW INDIVIDUAL

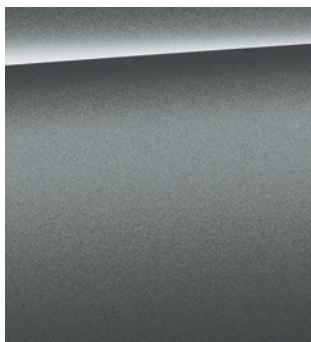

Metallic C4W Skyscraper Grey

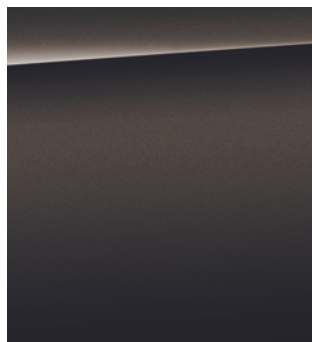

BMW Individual C36 Dravit Grey metallic

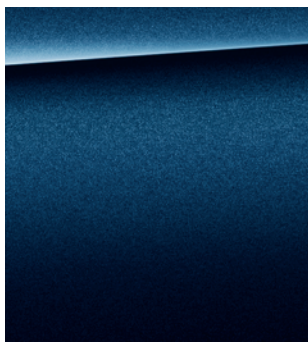

BMW Individual C3Z Tanzanite Blue metallic

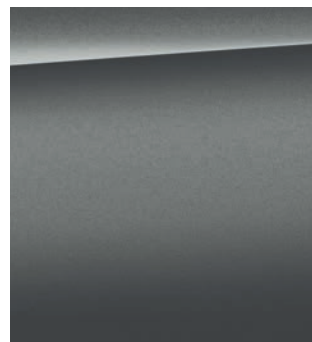

BMW Individual X1F Frozen Pure Grey metallic¹



BMW Individual X1G Frozen Tanzanite Blue metallic¹

[Colour samples] These colour samples are intended as an initial guide to the colours and materials available for your BMW. However, experience has shown that printed versions of paint, upholstery and interior trim colours cannot in all cases faithfully reproduce the appearance of the original colour. Please discuss your preferred colour choices with your BMW partner or in your dealership. There you can also see original samples and be assisted with special requests.

¹ Only in conjunction with the M Sport package.

The availability of some equipment features, functions and digital services depends on engine versions or additional optional equipment. The offer structure as well as market and production availability may vary. For detailed information about availabilities, duration and costs, contact your local BMW authorised workshop.

INTERIOR COLOURS.

UPHOLSTERY

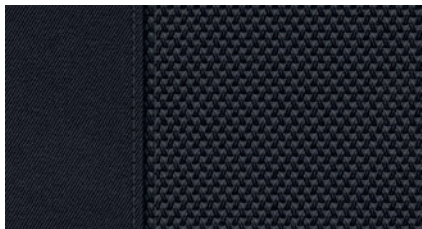

Cloth 'Hevelius' EHAT Anthracite¹

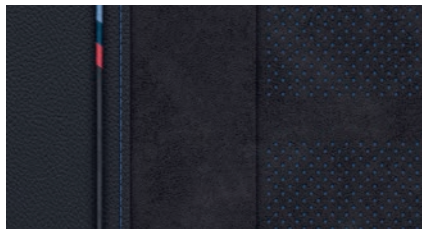

Alcantara/Sensatec combination KGNL Black with perforation, accent Blue^{2,3}



Sensatec perforated KHFY Canberra Beige

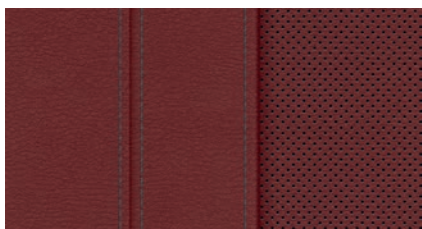

Sensatec perforated KHG7 Tacora Red

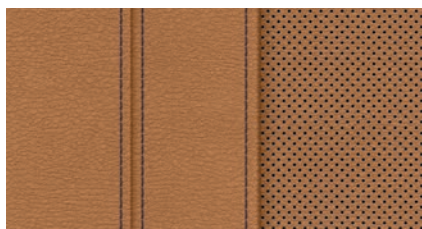

Sensatec perforated KHKC Cognac

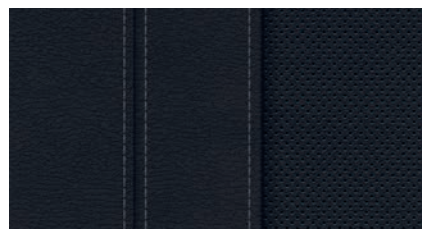

Sensatec perforated KHSW Black

UPHOLSTERY COMBINATION

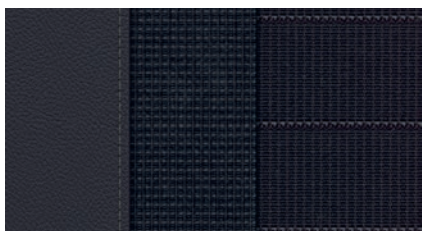

Cloth/Sensatec combination KFSW Black

LEATHER

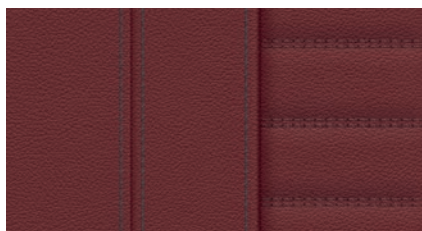

Leather 'Vernasca' MAG6 Tacora Red with decorative stitching

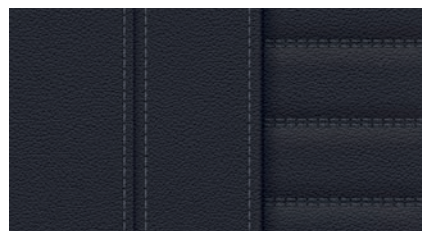

Leather 'Vernasca' MAH7 Black decor stitching

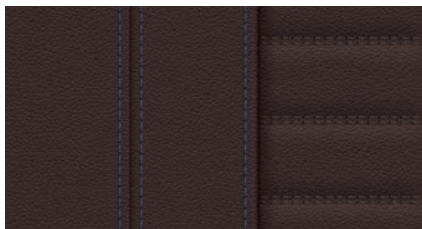

Leather 'Vernasca' MAMU Mocha with decorative stitching

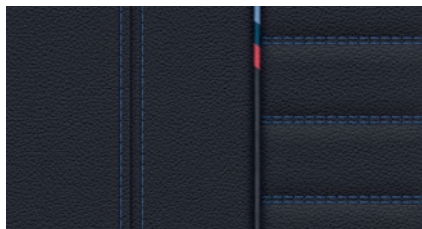

Leather 'Vernasca' MANL Black, Blue contrast stitching⁴

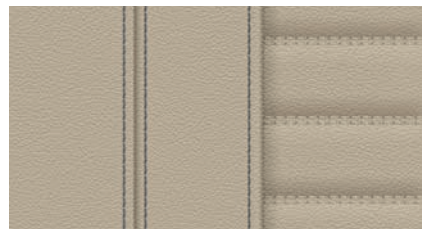

Leather 'Vernasca' MAOI Oyster with decorative stitching

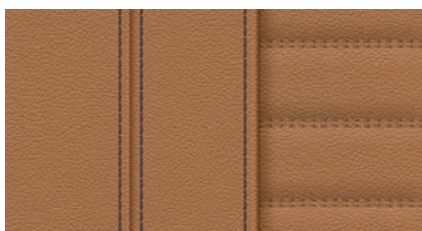

Leather 'Vernasca' MAPQ Cognac with decorative stitching⁴

¹ Standard equipment.

² Only in conjunction with the M Sport package.

³ Standard equipment for M Vehicles.

⁴ Only available in conjunction with M Sport package and M sport seats.

The availability of some equipment features, functions and digital services depends on engine versions or additional optional equipment. The offer structure as well as market and production availability may vary. For detailed information about availabilities, duration and costs, contact your local BMW authorised workshop.

INTERIOR COLOURS.

INDIVIDUAL LEATHER

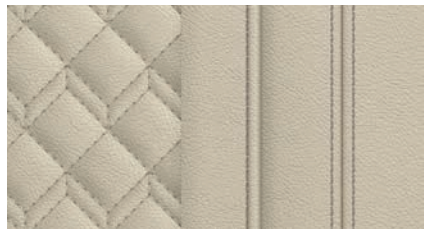

BMW Individual extended leather trim 'Merino'
VAEW Ivory White

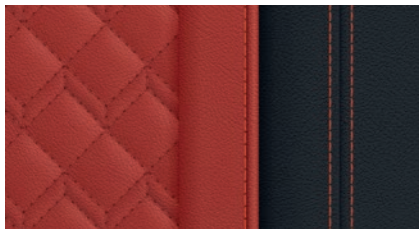

BMW Individual extended leather trim 'Merino'
VAHZ Fiona Red/Black

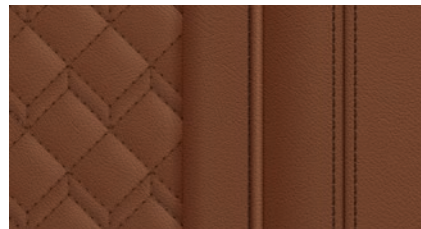

BMW Individual extended leather trim 'Merino'
VATQ Tartufo

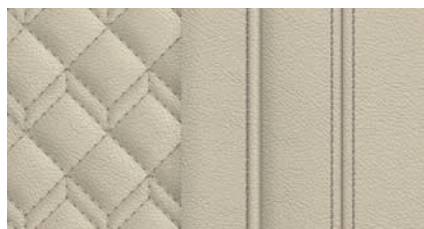

BMW Individual full leather trim 'Merino'
VBEW Ivory White

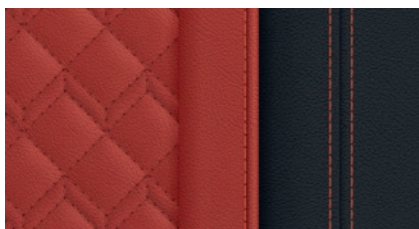

BMW Individual full leather trim 'Merino'
VBHZ Fiona Red/Black

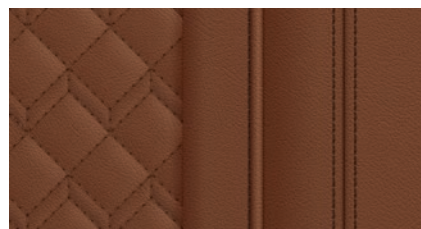

BMW Individual full leather trim 'Merino'
VBTQ Tartufo

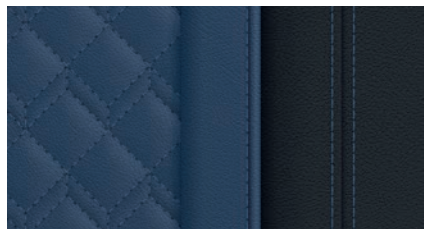

BMW Individual extended leather trim 'Merino'
ZAFV Fjord Blue/Black

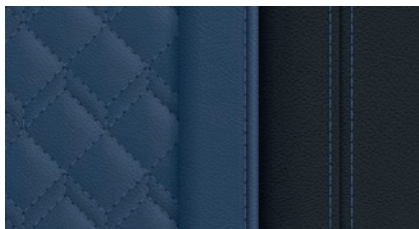

BMW Individual full leather trim 'Merino'
ZBFV Fjord Blue/Black

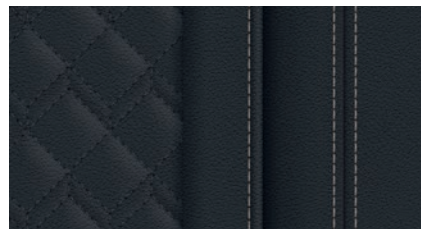

BMW Individual extended leather trim 'Merino'
ZASW Black



BMW Individual full leather trim 'Merino'
ZBSW Black

The availability of some equipment features, functions and digital services depends on engine versions or additional optional equipment. The offer structure as well as market and production availability may vary. For detailed information about availabilities, duration and costs, contact your local BMW authorised workshop.

INTERIOR COLOURS.

INTERIOR TRIM FINISHERS



Interior trim finishers black high-gloss



Interior trim finishers Quartz Silver matt, grained¹

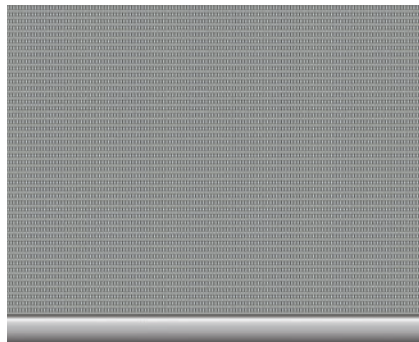

Interior trim finishers Aluminium 'Mesheffect'¹

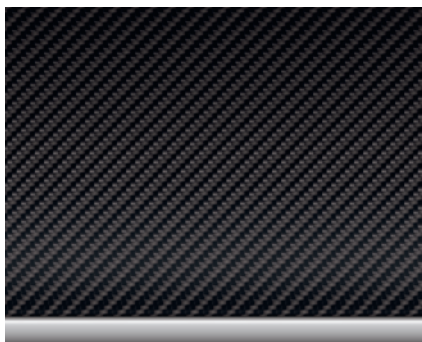

M interior trim finishers 'Carbon Fibre'²



Interior trim finishers Aluminium Rhombicle Anthracite³

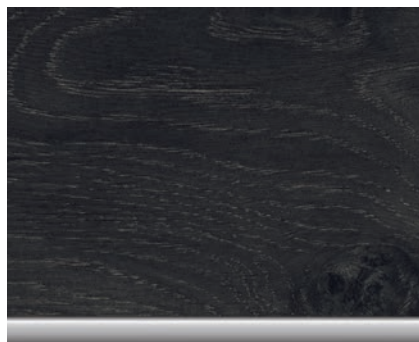

Fine-wood interior trim oak grain open-pored

INDIVIDUAL INTERIOR TRIM FINISHERS

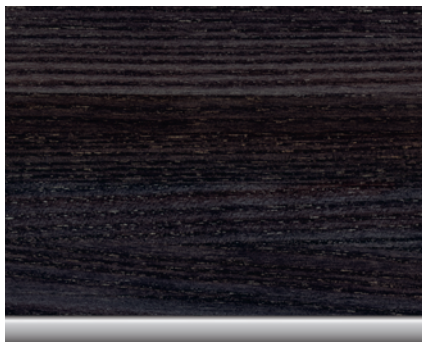

Fine-wood interior trim Ash grey-brown high-gloss



BMW Individual interior trim finishers piano finish Black



BMW Individual interior trim finishers Aluminium fabric high-gloss

¹ Standard equipment.

² Only in conjunction with the M Sport package.

³ Standard equipment for M Vehicles.

The availability of some equipment features, functions and digital services depends on engine versions or additional optional equipment. The offer structure as well as market and production availability may vary. For detailed information about availabilities, duration and costs, contact your local BMW authorised workshop.

EXTERIOR COLOURS. BMW M VEHICLES.

EXTERIOR COLOURS

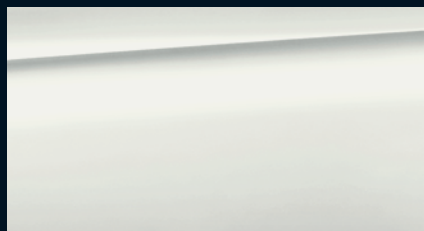

Non-metallic 300 Alpine White

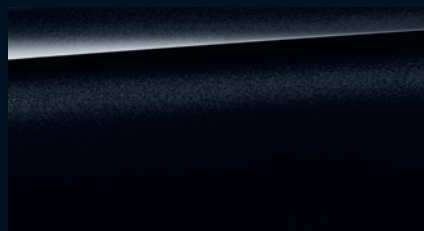

Metallic 475 Black Sapphire



Metallic A75 Melbourne Red



Metallic A96 Mineral White



Metallic C31 M Portimao Blue



Metallic C4P M Brooklyn Grey

BMW INDIVIDUAL

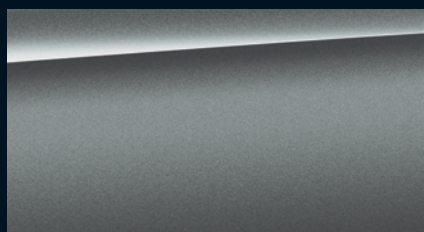

Metallic C4W Skyscraper Grey



BMW Individual C36 Dravit Grey metallic



BMW Individual C3Z Tanzanite Blue metallic

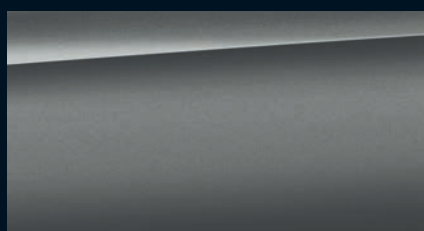

BMW Individual X1F Frozen Pure Grey metallic



BMW Individual X1G Frozen Tanzanite Blue metallic

The availability of some equipment features, functions and digital services depends on engine versions or additional optional equipment. The offer structure as well as market and production availability may vary. For detailed information about availabilities, duration and costs, contact your local BMW authorised workshop.

WHEELS AND TYRES. BMW M VEHICLES.



19" M light alloy wheels Double-spoke style 791 M Bicolour Jet Black with performance tyres and mixed tyres, gloss-lathed, front 8J x 19 with 225/40 R19 tyres, rear 8.5J x 19 with 255/35 R19 tyres.



19" M light alloy wheels Double-spoke style 792 M Bicolour Jet Black with performance tyres and mixed tyres, gloss-lathed, front 8J x 19 with 225/40 R19 tyres, rear 8.5J x 19 with 255/35 R19 tyres.



19" M light alloy wheels Double-spoke style 791 M Jet Black uni with performance tyres and mixed tyres, wheel size front 8J x 19 with 225/40 R19 tyres, wheel size rear 8.5J x 19 with 255/35 R19 tyres.



19" BMW Individual light alloy wheels Double-spoke style 793 I Bicolour Orbit Grey with mixed tyres and run-flat tyres, gloss-lathed, wheel size front 8J x 19 with 225/40 R19 tyres, wheel size rear 8.5J x 19 with 255/35 R19 tyres.



18" M light alloy wheels Double-spoke style 848 M Bicolour Jet Black with mixed tyres, gloss-lathed, wheel size front 7.5J x 18 with 225/45 R18 tyres, wheel size rear 8.5J x 18 with 255/40 R18 tyres.¹

¹ Standard equipment.

The availability of some equipment features, functions and digital services depends on engine versions or additional optional equipment. The offer structure as well as market and production availability may vary. For detailed information about availabilities, duration and costs, contact your local BMW authorised workshop.

INTERIOR COLOURS. BMW M VEHICLES.

LEATHER

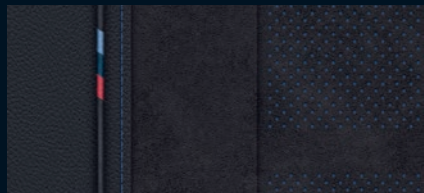

Alcantara/Sensatec combination KGNL Black with perforation, accent Blue¹



Leather 'Vernasca' MAG6 Tacora Red with decorative stitching



Leather 'Vernasca' MAH7 Black decor stitching



Leather 'Vernasca' MAMU Mocha with decorative stitching



Leather 'Vernasca' MANL Black, Blue contrast stitching²



Leather 'Vernasca' MAOI Oyster with decorative stitching



Leather 'Vernasca' MAPQ Cognac with decorative stitching²

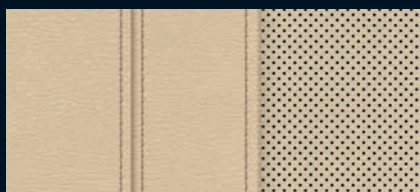

Sensatec perforated KHFY Canberra Beige

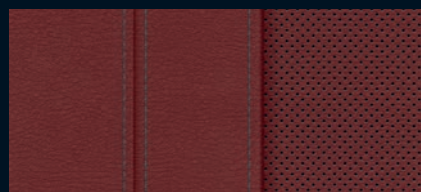

Sensatec perforated KHG7 Tacora Red



Sensatec perforated KHKC Cognac



Sensatec perforated KHSW Black

INDIVIDUAL LEATHER



BMW Individual extended leather trim 'Merino' ZASW Black



BMW Individual extended leather trim 'Merino' ZAFV Fjord Blue/Black

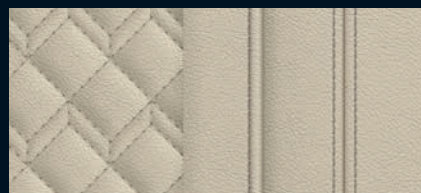

BMW Individual extended leather trim 'Merino' VAEW Ivory White

¹ Standard equipment.

² Only available in conjunction with M Sport package and M sport seats.

The availability of some equipment features, functions and digital services depends on engine versions or additional optional equipment. The offer structure as well as market and production availability may vary. For detailed information about availabilities, duration and costs, contact your local BMW authorised workshop.

INTERIOR COLOURS. BMW M VEHICLES.

INDIVIDUAL LEATHER



BMW Individual extended leather trim 'Merino'
VAHZ Fiona Red/Black

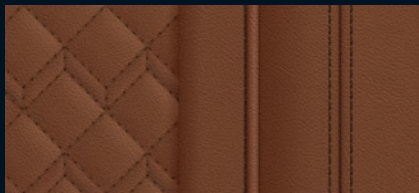

BMW Individual extended leather trim 'Merino'
VATQ Tartufo

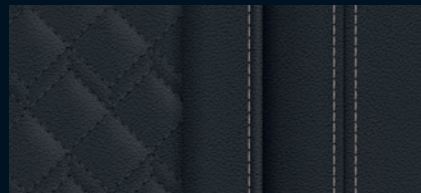

BMW Individual full leather trim 'Merino'
ZBSW Black



BMW Individual full leather trim 'Merino'
ZBFV Fjord Blue/Black

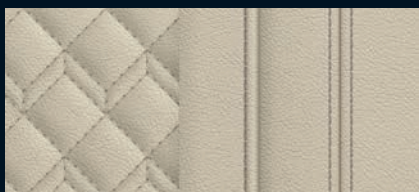

BMW Individual full leather trim 'Merino'
VBEW Ivory White



BMW Individual full leather trim 'Merino'
VBHZ Fiona Red/Black



BMW Individual full leather trim 'Merino'
VBTQ Tartufo

INTERIOR TRIM FINISHERS

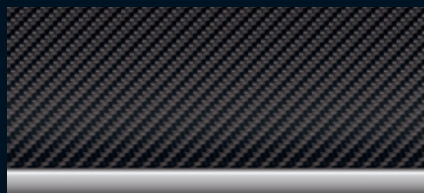

M interior trim finishers 'Carbon Fibre'

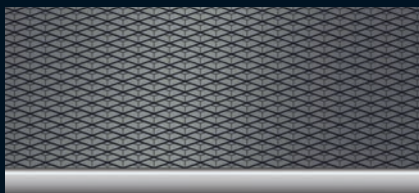

Interior trim finishers Aluminium Rhombic
Anthracite¹

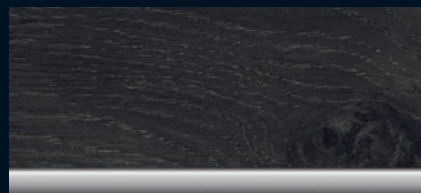

Fine-wood interior trim oak grain open-pored



Fine-wood interior trim Ash grey-brown high-gloss

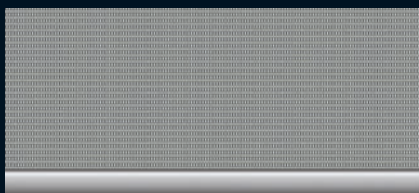

Interior trim finishers Aluminium 'Mesheffect'



BMW Individual interior trim finishers piano finish
Black

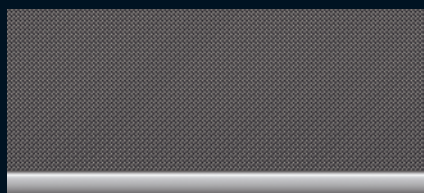

BMW Individual interior trim finishers Aluminium
fabric high-gloss

¹ Standard equipment.

The availability of some equipment features, functions and digital services depends on engine versions or additional optional equipment. The offer structure as well as market and production availability may vary. For detailed information about availabilities, duration and costs, contact your local BMW authorised workshop.



ORIGINAL BMW ACCESSORIES.

Intensive driving experiences, even further enhanced: Original BMW accessories are the best match for an original BMW. Whether you're looking for wheels and tyres, transport and luggage compartment solutions, interior equipment, communication, information and technology, charging accessories or M performance parts, with genuine BMW accessories you'll find exactly the individual solution that will allow you to discover driving pleasure as if for the first time.



WHEELS AND TYRES.

With original BMW complete wheels, you'll reach your destination safely, and emphasise the sporty appearance of your BMW from the very first glance. But what you don't immediately realise is that they are precisely tailored to your BMW, are subject to very stringent tests with intensive material and function checks, and have been developed in close collaboration with leading tyre manufacturers – individually tuned to the driving dynamics and design language of each individual BMW model.

TRANSPORT AND LUGGAGE COMPARTMENT SOLUTIONS.

Original BMW Accessories offer you a wide range of transport and luggage compartment solutions. In line with your personal preferences and interests, you can use them to create additional space whenever and wherever you need it. Whether carrier systems or accessories for the luggage compartment, you can always rely on original BMW accessories to be precisely tailored to your BMW, and easy to use.



INTERIOR ACCESSORIES.

A perfect fit: all original BMW accessory products for the interior help to design the interior of your BMW to fully meet your personal preferences. In addition to the excellent functionality of original BMW accessories, you are also always choosing attractive BMW design alongside extraordinary craftsmanship and material quality – combined with an ambience that will excite you every time you drive.



COMMUNICATION, INFORMATION AND TECHNOLOGY.

Cutting-edge functions and features for maximum freedom and flexibility: Original BMW accessories for communication, information and technology are always at your side. Whether you value optimum availability by phone or the best sound, the innovative original BMW accessories will have the right solution for you. You'll always enjoy a good connection and custom entertainment, wherever your journey takes you.

CHARGING ACCESSORIES.

Regardless of where and how you want to charge your new BMW, original BMW charging accessories offer you tailor-made products and services. You can charge your BMW at any domestic socket using the BMW Flexible Fast Charger or, for even more convenience, at a BMW Wallbox from original BMW accessories; what's more, there's also a widespread network of public charging points available for when you're on the road. Innovative Connected Charging services show charging stations in your BMW's information display, for example, or enable you to easily start pre-conditioning your vehicle just using your smartphone.



M PERFORMANCE PARTS.

With M performance parts, you can experience BMW's motorsport DNA with fascinating intensity, even off the racetrack. A wide range of technical and visual components makes outstanding technology a visible and tangible experience. Exclusive materials and first-rate quality guarantee flawless dynamism. Experience inspiring maximum product performance: individual, expressive and uncompromising.

The availability of the equipment shown and described may vary on a market-specific basis. Your local BMW partner will be happy to advise you on the full range of original BMW accessories.

Discover the whole range of original BMW accessories and the BMW M performance parts product portfolio.



GENUINE BMW ACCESSORIES.

The modern roof box in black with titanium silver side panels has a capacity of 520 litres and is compatible with all BMW roof rack systems. Due to the fact that it can be opened from both sides and has triple central locking on each side it is convenient to load and lock for theft protection.



19" BMW light alloy wheels Double-spoke style 793 in Bicolor Night Gold, gloss-lathed. Summer complete wheel set with tyre pressure monitor and run-flat tyres.



The perfectly fitted, durable BMW all-weather floor mats with a raised border and elegant design protect the front footwell against moisture and dirt. They are black and feature a high-quality stainless steel inlay.



The BMW rear bicycle rack Pro 2.0 is lightweight yet sturdy and can carry up to 60 kg. Outstandingly easy to handle, it can transport two bicycles or e-bikes (can be extended to accommodate three bicycles). Its tilt function allows easy access to the luggage compartment at any time.

The availability of some equipment features, functions and digital services depends on engine versions or additional optional equipment. The offer structure as well as market and production availability may vary. For detailed information about availabilities, duration and costs, contact your local BMW authorised workshop.

GENUINE BMW ACCESSORIES. M VEHICLES.



100 percent high-tech. 100 percent motorsport character. 100 percent enthusiasm. The M Performance rear diffuser from carbon is crafted meticulously by hand. It creates an even more modern appearance – and makes the vehicle's sporty look even more impressive.

Moving design. The M Performance roof spoiler is made of PUR in black high-gloss, an elegantly athletic accent for the rear of the vehicle. At the same time, it contributes to optimised aerodynamics. The spoiler is perfectly tailored to the vehicle design and can be painted in the body colour.

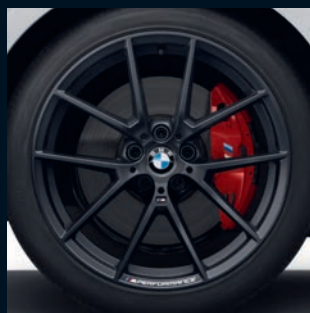

19" M Performance light alloy wheel Y-spoke style 898 M in Frozen Gunmetal Grey. Winter wheel with tyre, front, with tyre pressure monitor and emergency running properties.

The availability of some equipment features, functions and digital services depends on engine versions or additional optional equipment. The offer structure as well as market and production availability may vary. For detailed information about availabilities, duration and costs, contact your local BMW authorised workshop.

TECHNICAL VALUES.

BMW 3 Series		318i	320i	330i	330i xDrive	318d ¹⁰	320d ¹⁰	320d xDrive ¹⁰
Complete vehicle drive system²								
Drive type		Petrol	Petrol	Petrol	Petrol	Diesel – 48-volt mild hybrid	Diesel – 48-volt mild hybrid	Diesel – 48-volt mild hybrid
Power	kW (hp)	115 (156)	135 (184)	180 (245)	180 (245)	110 (150)	140 (190)	140 (190)
Torque	Nm	250	300	400	400	320	400	400
Transmission		8-speed, automatic	8-speed, automatic	8-speed, automatic	8-speed, automatic	8-speed, automatic	8-speed, automatic	8-speed, automatic
Drive type		Rear-wheel drive	Rear-wheel drive	Rear-wheel drive	All-wheel drive	Rear-wheel drive	Rear-wheel drive	All-wheel drive
BMW TwinPower Turbo engine²								
Cylinders		4	4	4	4	4	4	4
Capacity	cm ³	1998	1998	1998	1998	1995	1995	1995
Rated output	kW (hp)/rpm	115 (156)/4500–6500	135 (184)/5000–6500	180 (245)/4500–6500	180 (245)/4500–6500	110 (150)/4000	140 (190)/4000	140 (190)/4000
Rated torque	Nm/rpm	250/1300–4300	300/1350–4400	400/1600–4000	400/1600–4000	320/1500–3000	400/1750–2500	400/1750–2500
Electric motor⁵								
(Nominal) output / 30 minutes output ⁷	kW (hp)	–	–	–	–	8 (11) / –	8 (11) / –	8 (11) / –
(Rated) torque	Nm	–	–	–	–	25	25	25
Driving performance								
Acceleration 0–100 km/h	s	8.8	7.6	6.1	6.0	8.8	7.2	7.5
Top speed	km/h	218	230	250	250	213	229	225
Top speed (electric)	km/h	–	–	–	–	–	–	–
Consumption / CO₂ emissions^{2,3}								
Fuel consumption, combined WLTP ⁸	l/100 km	7.5–6.7	7.5–6.7	7.6–6.8	8.1–7.3	5.7–5.0	5.7–5.0	6.0–5.3
CO ₂ emissions, combined WLTP	g/km	168–151	169–151	172–154	182–164	149–132	150–132	157–139
Consumption, electrical, combined WLTP	kWh/100 km	–	–	–	–	–	–	–
Electric range WLTP ⁴	km	–	–	–	–	–	–	–
High-voltage/48-volt battery, charging⁹								
Battery size	kWh	–	–	–	–	0.46	0.46	0.46
Maximum charging power AC	kW	–	–	–	–	–	–	–
Charging time AC 0–100%	h	–	–	–	–	–	–	–
Dimensions/weight								
Length / width / height	mm	4713 / 1827 / 1440	4713 / 1827 / 1440	4713 / 1827 / 1440	4713 / 1827 / 1445	4713 / 1827 / 1440	4713 / 1827 / 1440	4713 / 1827 / 1445
Wheelbase	mm	2851	2851	2851	2851	2851	2851	2851
Unladen weight ¹	kg	1650	1660	1675	1735	1735	1740	1800
Luggage capacity	l	500–1510	500–1510	500–1510	500–1510	500–1510	500–1510	500–1510
Fuel tank capacity	l	59	59	59	59	59	59	59
Trailer load optionally braked ex works up to 12% / trailer load	kg	1300 / 75	1600 / 75	1600 / 75	1800 / 75	1800 / 75	1800 / 75	1800 / 75

¹ The EC unladen weight refers to a vehicle with standard equipment and does not include any optional equipment. The unladen weight includes a 90% full tank and a driver weight of 75 kg. Optional equipment may affect the weight of the vehicle, the payload and the top speed if the selected equipment has an impact on the vehicle's aerodynamics.

² Performance data of petrol engines applies to vehicles using RON 98 grade fuel. Fuel consumption data applies to vehicles using reference fuels in accordance with EU Regulation 2007/715. Unleaded RON 91 fuel and higher with a maximum ethanol content of 10% (E10) may also be used. BMW recommends RON 95 unleaded premium grade fuel.

³ Official data for fuel consumption, CO₂ emissions, power consumption and electric range was determined in accordance with the prescribed measuring procedure and corresponds to European Regulation (EC) 715/2007 in the applicable version. For ranges, data determined as per WLTP takes into account any optional equipment (available on the German market in this case). For vehicles that have been newly type approved since 1 January 2021, only the official data according to WLTP exists. For more information about NEDC and WLTP measuring procedures visit www.bmw.com/wltp

⁴ Range depends on various factors, in particular: individual driving style, route characteristics, outside temperature, heating/air conditioning, pre-conditioning.

⁵ At temperatures below freezing, the fully electric drive system is only available after a few kilometres of driving, once the battery has heated to operational temperature.

⁶ Comprises engine driven (specified nominal value) and electric drive (up to specified nominal value).

⁷ Power depends on the battery charge.

⁸ For plug-in hybrid: weighted, combined (EC AC charge weighted).

⁹ Charging times/charging rate specified under optimal conditions (29–33 degrees Celsius battery start and ambient temperature with certification values excluding additional auxiliary consumers such as seat heating, displays, air-conditioning system).

¹⁰ This engine version is not available in all countries. For further information, please contact your local BMW authorised workshop.

TECHNICAL VALUES.

BMW 3 Series		330d ¹⁰	330d xDrive ¹⁰	320e	320e xDrive	330e	330e xDrive
Complete vehicle drive system²							
Drive type		Diesel – 48-volt mild hybrid	Diesel – 48-volt mild hybrid	Petrol – plug-in hybrid	Petrol – plug-in hybrid	Petrol – plug-in hybrid	Petrol – plug-in hybrid
Power	kW (hp)	210 (286)	210 (286)	150 (204) ^{6,7}	150 (204) ^{6,7}	215 (292) ^{6,7}	215 (292) ^{6,7}
Torque	Nm	650	650	350 ⁶	350 ⁶	420 ⁶	420 ⁶
Transmission		8-speed, automatic	8-speed, automatic	8-speed, automatic	8-speed, automatic	8-speed, automatic	8-speed, automatic
Drive type		Rear-wheel drive	All-wheel drive	Rear-wheel drive	All-wheel drive	Rear-wheel drive	All-wheel drive
BMW TwinPower Turbo engine²							
Cylinders		6	6	4	4	4	4
Capacity	cm ³	2993	2993	1998	1998	1998	1998
Rated output	kW (hp)/rpm	210 (286)/4000	210 (286)/4000	120 (163)/3900–6500	120 (163)/3900–6500	135 (184)/5000–6500	135 (184)/5000–6500
Rated torque	Nm/rpm	650/1500–2500	650/1500–2500	300/1350–3700	300/1350–3700	300/1350–4000	300/1350–4000
Electric motor⁵							
(Nominal) output / 30 minutes output ⁷	kW (hp)	8 (11) / –	8 (11) / –	80 (109) / 55 (75)	80 (109) / 55 (75)	80 (109) / 55 (75)	80 (109) / 55 (75)
(Rated) torque	Nm	25	25	265	265	265	265
Driving performance							
Acceleration 0–100 km/h	s	5.5	5.2	7.9	8.2	5.9	5.9
Top speed	km/h	250	250	220	219	230	225
Top speed (electric)	km/h	–	–	140	140	140	140
Consumption / CO₂ emissions^{2,3}							
Fuel consumption, combined WLTP ⁸	l/100 km	6.0–5.3	6.3–5.6	1.9–1.4	2.1–1.5	1.9–1.4	2.1–1.5
CO ₂ emissions, combined WLTP	g/km	157–140	165–148	43–31	48–34	42–31	48–35
Consumption, electrical, combined WLTP	kWh/100 km	–	–	18.3–16.3	19.0–16.7	18.1–16.1	19.2–16.9
Electric range WLTP ⁴	km	–	–	52–61	48–59	53–61	47–58
High-voltage/48-volt battery, charging⁹							
Battery size	kWh	0.46	0.46	11.2	11.2	11.2	11.2
Maximum charging power AC	kW	–	–	3.7	3.7	3.7	3.7
Charging time AC 0–100%	h	–	–	3.6	3.6	3.6	3.6
Dimensions/weight							
Length / width / height	mm	4713 / 1827 / 1440	4713 / 1827 / 1445	4713 / 1827 / 1442	4713 / 1827 / 1442	4713 / 1827 / 1442	4713 / 1827 / 1442
Wheelbase	mm	2851	2851	2851	2851	2851	2851
Unladen weight ¹	kg	1845	1900	1900	1955	1900	1955
Luggage capacity	l	500–1510	500–1510	410–1420	410–1420	410–1420	410–1420
Fuel tank capacity	l	59	59	40	40	40	40
Trailer load optionally braked ex works up to 12% / trailer load	kg	1800 / 75	1800 / 75	1500 / 75	1500 / 75	1500 / 75	1500 / 75

¹ The EC unladen weight refers to a vehicle with standard equipment and does not include any optional equipment. The unladen weight includes a 90% full tank and a driver weight of 75 kg. Optional equipment may affect the weight of the vehicle, the payload and the top speed if the selected equipment has an impact on the vehicle's aerodynamics.

² Performance data of petrol engines applies to vehicles using RON 98 grade fuel. Fuel consumption data applies to vehicles using reference fuels in accordance with EU Regulation 2007/715. Unleaded RON 91 fuel and higher with a maximum ethanol content of 10% (E10) may also be used. BMW recommends RON 95 unleaded premium grade fuel.

³ Official data for fuel consumption, CO₂ emissions, power consumption and electric range was determined in accordance with the prescribed measuring procedure and corresponds to European Regulation (EC) 715/2007 in the applicable version. For ranges, data determined as per WLTP takes into account any optional equipment (available on the German market in this case). For vehicles that have been newly type approved since 1 January 2021, only the official data according to WLTP exists. For more information about NEDC and WLTP measuring procedures visit www.bmw.com/wltp

⁴ Range depends on various factors, in particular: individual driving style, route characteristics, outside temperature, heating/air conditioning, pre-conditioning.

⁵ At temperatures below freezing, the fully electric drive system is only available after a few kilometres of driving, once the battery has heated to operational temperature.

⁶ Comprises engine driven (specified nominal value) and electric drive (up to specified nominal value).

⁷ Power depends on the battery charge.

⁸ For plug-in hybrid: weighted, combined (EC AC charge weighted).

⁹ Charging times/charging rate specified under optimal conditions (29–33 degrees Celsius battery start and ambient temperature with certification values excluding additional auxiliary consumers such as seat heating, displays, air-conditioning system).

¹⁰ This engine version is not available in all countries. For further information, please contact your local BMW authorised workshop.

TECHNICAL VALUES.

BMW 3 Series

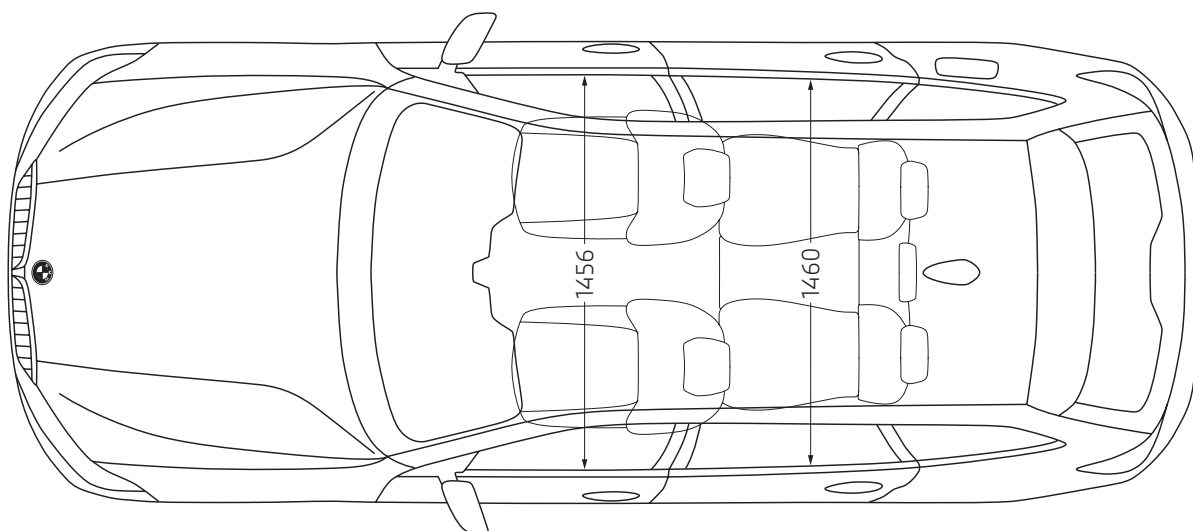
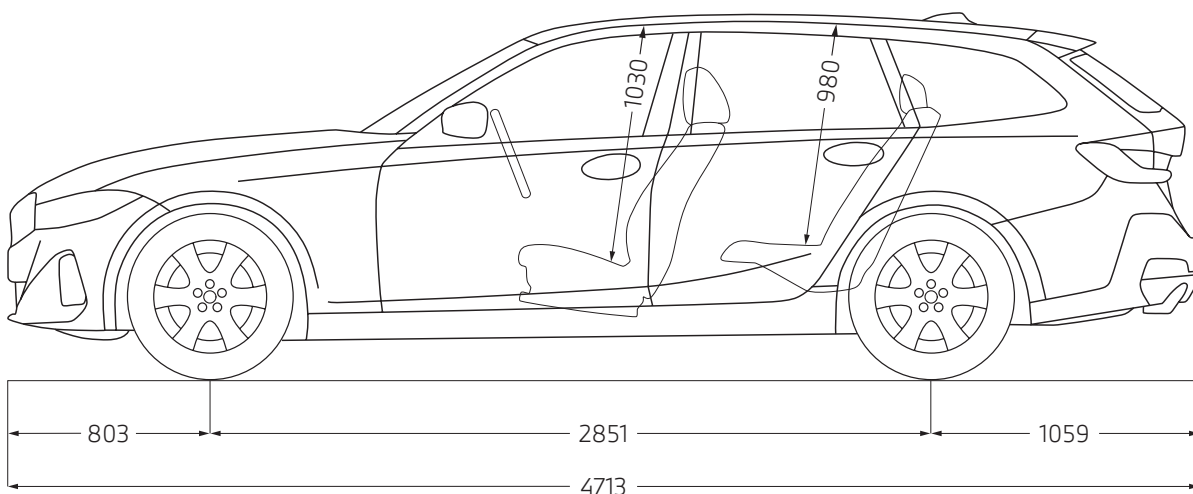
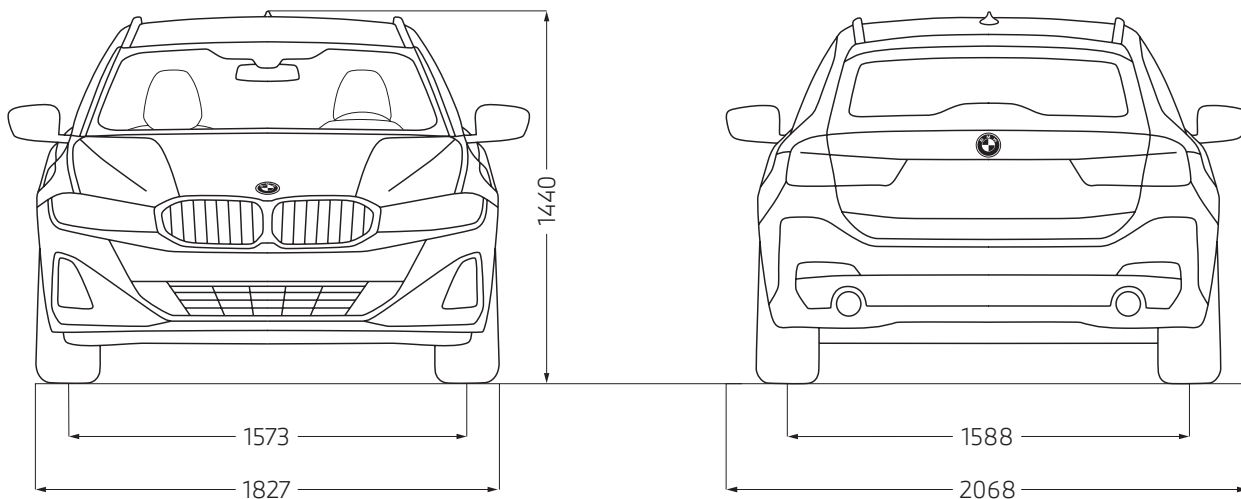

The dimensions in the technical drawing are in millimetres and may vary depending on the model and optional equipment.



TECHNICAL VALUES.

BMW 3 Series M Vehicles		M340i xDrive ⁹	M340d xDrive ⁹
Complete vehicle drive system²			
Drive type		Petrol – 48-volt mild hybrid	Diesel – 48-volt mild hybrid
Power	kW (hp)	275 (374)	250 (340)
Torque	Nm	500	700
Transmission		8-speed, automatic	8-speed, automatic
Drive type		All-wheel drive	All-wheel drive
BMW TwinPower Turbo engine²			
Cylinders		6	6
Capacity	cm ³	2998	2993
Rated output	kW (hp)/rpm	275 (374)/5500–6500	250 (340)/4400
Rated torque	Nm/rpm	500/1900–5000	700/1750–2250
Electric motor⁵			
(Nominal) output / 30 minutes output ⁶	kW (hp)	8 (11) / –	8 (11) / –
(Rated) torque	Nm	25	25
Driving performance			
Acceleration 0–100 km/h	s	4.6	4.7
Top speed	km/h	250	250
Top speed (electric)	km/h	–	–
Consumption / CO₂ emissions^{2,3}			
Fuel consumption, combined WLTP ⁷	l/100 km	8.8–8.1	6.6–6.0
CO ₂ emissions, combined WLTP	g/km	197–182	173–157
Consumption, electrical, combined WLTP	kWh/100 km	–	–
Electric range WLTP ⁴	km	–	–
High-voltage/48-volt battery, charging⁸			
Battery size	kWh	0.46	0.46
Maximum charging power AC / DC	kW	–	–
Charging time AC 0–100%	h	–	–
Dimensions/weight			
Length/width/height	mm	4714 / 1827 / 1440	4713 / 1827 / 1445
Wheelbase	mm	2851	2851
Unladen weight ¹	kg	1870	1945
Luggage capacity	l	500–1510	500–1510
Fuel tank capacity	l	59	59
Trailer load optionally braked ex works up to 12% / trailer load	kg	1800 / 75	1800 / 75

¹ The EC unladen weight refers to a vehicle with standard equipment and does not include any optional equipment. The unladen weight includes a 90% full tank and a driver weight of 75 kg. Optional equipment may affect the weight of the vehicle, the payload and the top speed if the selected equipment has an impact on the vehicle's aerodynamics.

² Performance data of petrol engines applies to vehicles using RON 98 grade fuel. Fuel consumption data applies to vehicles using reference fuels in accordance with EU Regulation 2007/715. Unleaded RON 91 fuel and higher with a maximum ethanol content of 10% (E10) may also be used. BMW recommends RON 95 unleaded premium grade fuel.

³ Official data for fuel consumption, CO₂ emissions, power consumption and electric range was determined in accordance with the prescribed measuring procedure and corresponds to European Regulation (EC) 715/2007 in the applicable version. For ranges, data determined as per WLTP takes into account any optional equipment (available on the German market in this case). For vehicles that have been newly type approved since 1 January 2021, only the official data according to WLTP exists. For more information about NEDC and WLTP measuring procedures visit www.bmw.com/wltp

⁴ Range depends on various factors, in particular: individual driving style, route characteristics, outside temperature, heating/air conditioning, pre-conditioning.

⁵ At temperatures below freezing, the fully electric drive system is only available after a few kilometres of driving, once the battery has heated to operational temperature.

⁶ Power depends on the battery charge.

⁷ For plug-in hybrid: weighted, combined (EC AC charge weighted).

⁸ Charging times/charging rate specified under optimal conditions (29–33 degrees Celsius battery start and ambient temperature with certification values excluding additional auxiliary consumers such as seat heating, displays, air-conditioning system).

⁹ This engine version is not available in all countries. For further information, please contact your local BMW authorised workshop.





BMW SERVICE.



Always there for you: Your BMW Service Partner is there for helpful, expert support for everything to do with your BMW. Our aim is to make every journey in your BMW as pleasant as possible. A major worldwide network of workshops offers premium service from BMW specialists, innovative diagnostic technologies, and rapid availability of precisely fitting original BMW parts as well as original BMW engine oil. There are many great reasons to choose services from BMW, but there's one that really stands out: that driving pleasure that sets your BMW apart from the crowd will be yours to enjoy for many years to come with BMW Service.

WHEREVER, WHENEVER: OUR COMPREHENSIVE SERVICE.

Many BMW services can be easily booked and tracked online – so you can use your time for the really important things in life. Stay independent and flexible with online appointments and remote services.

Take advantage of our innovative digital products and services such as online video advice, and get all the relevant information on your smartphone. And if you don't want to stop but have no choice, our BMW Breakdown and Accident Assistance service will help.



SUSTAINABILITY.



The BMW Group has been finishing at the top end of independent ratings and rankings that assess sustainability for a long time. These successes and increasing challenges in protecting the world we live in encourage us to embed sustainability as a key aspect in our corporate strategy. The development of efficient vehicle concepts, the establishment of eco-friendly production processes and the implementation of sustainable processes at our suppliers is part of our philosophy. Efficiency-enhancing technologies such as BMW EfficientDynamics and consistent electrification have enabled us to cut the CO₂ emissions of our

fleet of vehicles in Europe by 50% between 1995 and 2020. In addition, between 2006 and 2020 we have reduced the consumption of water by 31% and the consumption of energy in production by 38%. Our plants worldwide use green electricity only. Since 2021 our plants have even been producing completely carbon neutrally. And, of course, each of our vehicles is designed for easy or economical recycling after its long-running life. Please contact your BMW partner on all matters regarding your end-of-life vehicle. For more information on this issue please visit our website.



DRIVING YOURSELF IS FUN.

SOME THINGS YOU SIMPLY HAVE TO EXPERIENCE FOR YOURSELF – LIKE THE NEW BMW 3 SERIES. STUNNINGLY SPORTY HANDLING, FLEXIBLE EVERYDAY SUITABILITY, FASCINATING DESIGN: BOOK A TEST DRIVE NOW AND DISCOVER THE NEW BMW 3 SERIES!



NOTE

Or doodles.

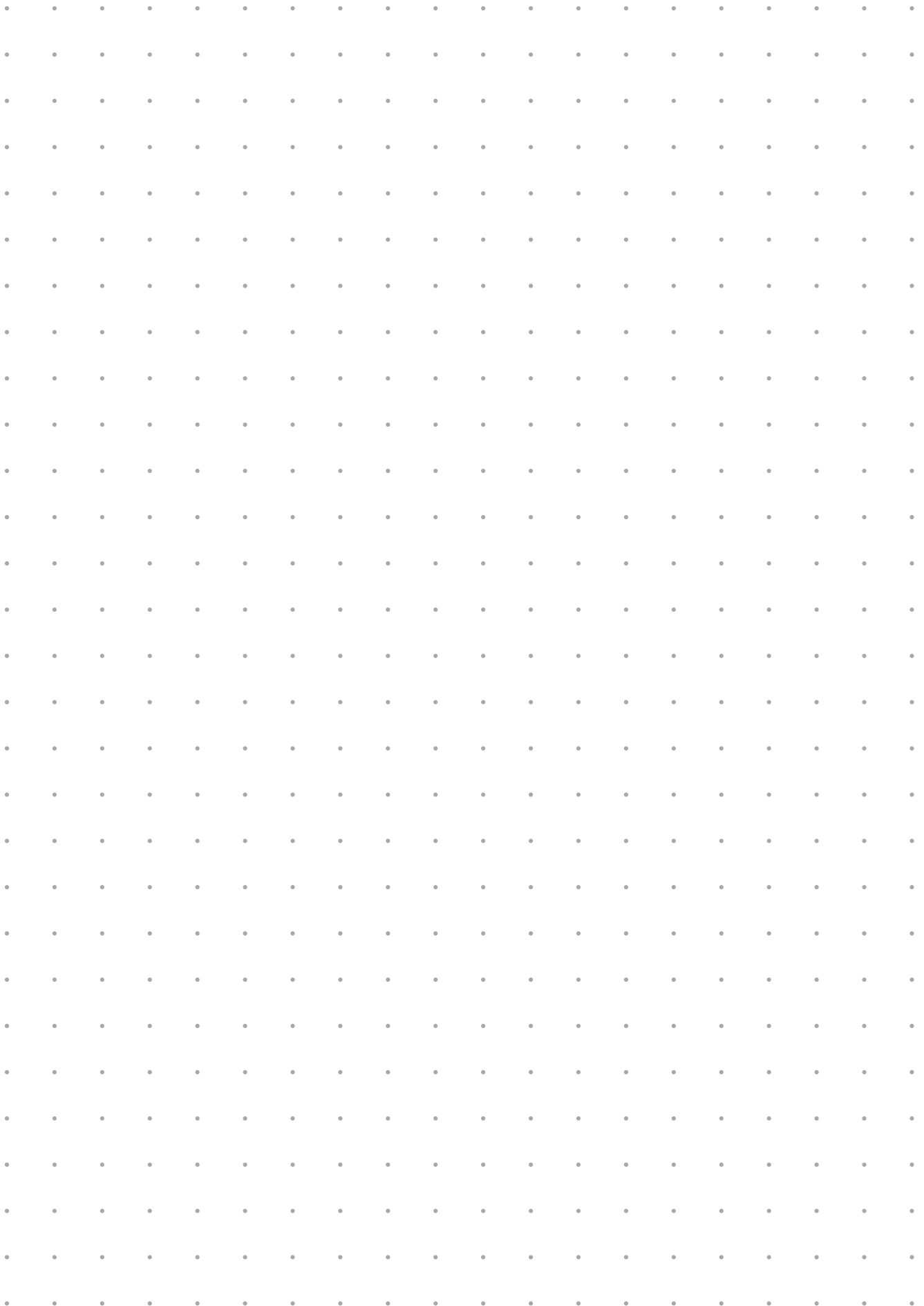

Of course, each vehicle is designed for economical recycling after its long-running life. You can find more information regarding your end-of-life vehicle on our website.

©2024 BMW Czech Republic s.r.o. Not to be reproduced wholly or in part without prior written permission.