

T H E

7



YOUR WORLD. MY BMW.



This feature is only available in conjunction with ConnectedDrive Services and a compatible smartphone. The availability and functions of the My BMW App depend on the vehicle model and may vary depending on the market.



The direct connection to your vehicle and the world of BMW: Conveniently check the vehicle status with the new My BMW App, access functions remotely, make a service appointment, plan trips and much more – this way, the app becomes your daily mobility companion.

Try it out for yourself and install the My BMW App from your Google play or App Store.





Highlights

- Exterior and interior
- Comfort and functionality
- Connectivity
- Driving dynamics
- Assistance systems
- Charging

Vehicle types

Models & packages

- M Sport package
- M Sport package Pro
- BMW 7 Series plug-in hybrids
- BMW 7 Series electric vehicle
- BMW 7 Series M Vehicle

Equipment

Equipment highlights
Wheels and tyres
Exterior colour world
Interior colour world
Genuine BMW Accessories

Technical values

BMW Services

THIS IS FORWARDISM.



◆

Forwardism is for those with the collective mindset to shape what's next. For those committed to tomorrow, restlessly striving for more. For those who believe in the merits of progress. Who believe to move is to grow. Not only enriching themselves but enriching those around them. For those with progressiveness as their natural state.



EVERY MOVEMENT
CREATES ITS
OWN ICON.





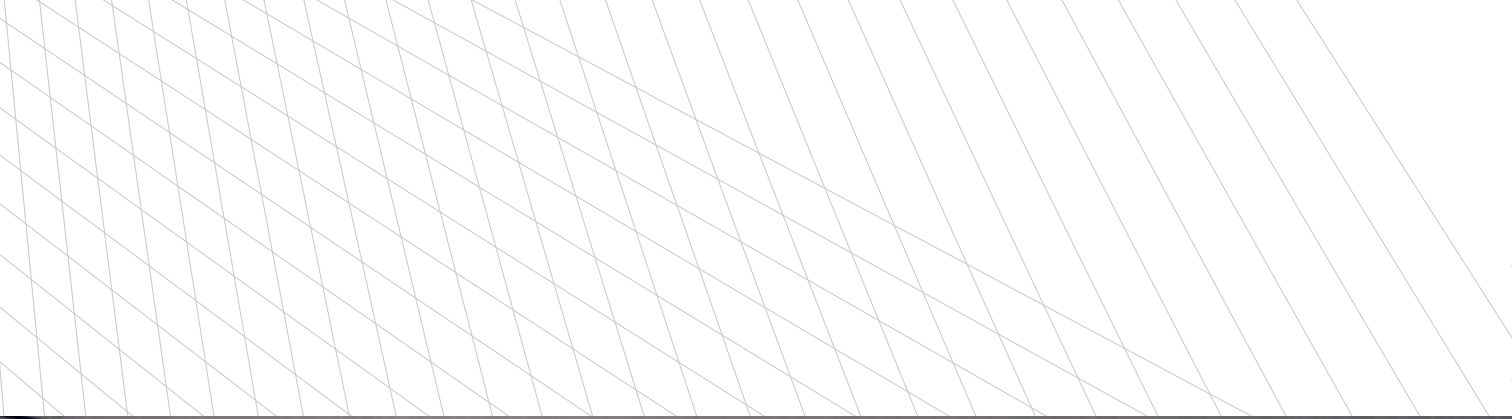

LUXURY
REDEFINED.



BOLDLY SHAPING THE FUTURE.

Pure presence that captivates: the BMW 7 Series marks the beginning of a new era and makes a clear statement for the future. Progressive, bold and unmistakable is the new, style-defining face of the BMW 7 Series – impressively characterised by the typical, illuminated BMW kidney grille and the extremely slim crystal headlights Iconic Glow.





COMPLETENESS AT FIRST GLANCE.

Precise lines emphasise the elongated silhouette of the BMW 7 Series. Generous surfaces and seamless transitions characterise the aesthetics of its impressive appearance. And the sporty, elegant BMW Individual Two-Tone paintwork reveals its unmistakable character in every respect.







Descriptions and illustrations include optional equipment.

PROGRESS ONLY GOES IN ONE DIRECTION.

Even the first impression proves that the BMW 7 Series was created to drive ahead. Extensive contours, clear shapes and narrow rear lights give the rear a powerful and superior appearance giving full effect to its elegance.





Descriptions and illustrations include optional equipment.
* Details in high-gloss black only in conjunction with optional M Performance package.



AESTHETICS THAT PROMISE SUPERIOR POWER.

In the BMW M760e, elegance and sportiness form a combination that fascinates from the first second. The striking BMW kidney grille and selected design details in Black high-gloss* lend the sport saloon an athletic yet refined look, and impressively reveal the dynamism represented by the letter M.





A MEETING
OF VISIONARIES.

NICK KNIGHT, ONE OF THE MOST INFLUENTIAL AND VISIONARY FASHION PHOTOGRAPHERS, WAS INVITED TO CREATE A SERIES OF IMAGES OF THE NEW BMW I7. FOR THE LAUNCH OF THE NEW BMW I7, KNIGHT WAS INVITED TO CREATE A SET OF IMAGES OF THE CAR THAT REPRESENT THE CONCEPT OF "FORWARDISM", THE JOY OF SEEING AND FEELING THE FUTURE BEFORE IT HAS BEEN CREATED.



Mr. Knight, you once said that photography is a misunderstood medium because people presume it's about capturing the truth and something we see. But for you, photography is about creating something we can't see, a reflection of the artist's perception. How do you show us the things we can't see?

A photograph is a moment in time, taken completely out of context. It shows a small amount of something that reflects the interpretations of our desires. It is not a factual recording of what is in front of us. When I take a photograph, it is about what I want to see, what I desire and what surprises me.

If a skilled photographer can make us feel things we weren't feeling before, how did you approach photographing an object so familiar to us as a car?

With this campaign, I explicitly wanted to free people's perception up a little bit and allow them to interpret the images in a new way. That's why I inverted the color space digitally and when I looked at the screen, I saw a different world than the one in front of the camera. This was no longer the world we live in; it was a fantasy space that does not exist. It frees us up to enjoy things and feel new things. This not only offers new ways of seeing, but it also frees us from certain decisions and restrictions of reality.

When it comes to fashion film, you say that the narrative comes from the object that is being shown. If we transfer that to the BMW i7, what does that mean?

The car represents a series of values and decisions that have been made. The finish, the textures, everything that has gone into the car represents something. And to transport that, you need to understand these values, otherwise it's hard to take a good picture of it. I realized that when I started working for the Japanese designer Yohji Yamamoto in the mid-1980s. His clothes at that point were so different from anything that anybody had seen. They looked like a different proposal of the human form, and I tried to understand what he was trying to say with it. Fashion is about rejecting what is now and replacing it with something that is new. I think that was exactly what Yamamoto did back then, and I feel like BMW is doing the same with the BMW i7.

Tell us more about the narrative you found in this car.

The first thing I noticed when I got into the BMW i7 was that it is a safe and exciting space. There is a certain amount of luxury that comes with this car – you instantly feel safe, and stress melts away. It feels like it is especially made for you, like a custom experience, which is a luxury, too. I also noticed a level of engagement with the future. The car is already engaging in a new world that is starting to reveal itself around us. Artificial intelligence and technology are working for the driver, which makes every drive more enjoyable. You don't change a car as easily and quickly as the fashion industry might be changing, but this model reflects the change that is happening in society.

The new BMW i7 was born under the star of Forwardism and marks the start of a new era. What does the concept of Forwardism mean to you?

To me, Forwardism is about not being afraid of what is yet to come and of the enormous shifts that are happening in society. I'm very fascinated with the whole idea of virtual reality, avatar versions of ourselves, machine learning or artificial intelligence. As an artist, my job is to reflect who we are and create

a world that we want to live in, with beautiful things that touch emotions. To do that, I need to engage with the future, with robotics, with AI. I need to use new possibilities to create a better future with artistic visions of society.

And how does the concept of Forwardism reflect in your work with the BMW i7?

I love the idea that Forwardism is about going to the future instead of referencing the past. To me, that is the only way to really express and challenge ourselves. That's why I decided to invert the colors for this shooting, to work in a color space that says: "This is new. This is something you haven't seen before." That was my starting point for creating visuals that get people thinking about something new – and thinking forward. It was important to me that it didn't look like anything else that has been seen before.



THE NEW LIGHT
ON THE ROAD

NEW FACE, NEW SPARK. THE NEW BMW I7 BRINGS WITH IT TO THE ROAD A HEADLIGHT THAT PUTS EVERY OTHER LIGHT IN THE SHADE. IN PARTNERSHIP WITH SWAROVSKI, BMW HAS DEVELOPED A CRYSTAL HEADLIGHT THAT GUARANTEES AN EFFECT LIKE NEVER BEFORE.



BMW Design



The community of Wattens with its 8,000 inhabitants is home to a small miracle being worked behind inconspicuous facades as each crystal is produced. The colors, shapes and facets created here are the result of the tried-and-true manufacturing techniques shaped by founder Daniel Swarovski back at the end of the 19th century, as well as innovative high-tech methods that bring the seemingly impossible to life. This is also the case with the BMW Iconic Glow crystal headlights, which first saw the light of day with the launch of the new BMW i7.

PRECISION THROUGH MATERIAL.

Each Swarovski crystal starts its creation process in the glassworks, a harsh and hot environment, before it becomes more and more defined. It moves to the Crystal Factory of the Future to be cut and coated in the hands of a robot. But no crystal leaves the premises without being checked for quality – by an expert's eye and under a precision magnifier, of course. By combining their respective expertise and transferring this elaborate process to vehicle headlights, Swarovski and BMW are setting new standards on the road in the luxury segment.

A LOOK BEHIND THE CRYSTALS.

First of all, it's about the size of the crystals. It was important to Binder and his team that they "do not look like jewelry, but like a grown crystal." After that, the challenge was to find a way to keep the large crystals stable in the setting and ensure that they would still be stable in 15 years' time. Binder explains: "We didn't want to frame the crystals with jewelry claws for aesthetic reasons. That's why we developed a floating device on which they are clamped over inlets."

A NEW FACET OF LUXURY.

The crystal headlights also create a new facet of luxury in the automotive sector. Aside from their elaborate workmanship, their extraordinary properties are an essential element of the new "Great Entrance Moment": A light show begins as the driver approaches their car, from the kidney grille to the crystal headlights right up to a side carpet of light in the form of overlapping crystals. BMW sees it as shaping a future-proof luxury that marks a paradigm shift by prioritizing sustainability. Constantly looking ahead, the new crystal headlights are already illuminating the way to an exciting future in which light will play an increasingly important role –

for showcasing, for individualization and for personal driving pleasure.





Descriptions and illustrations include optional equipment.

STRIVING FOR EXCELLENCE.

The BMW 7 Series merges elegance, comfort and state-of-the-art technology to create an ambience in which every moment becomes an experience. The interior impresses with its reduction to the essentials – timeless, modern, clean. At the centre: the large BMW Curved Display and the BMW Interaction Bar between the almost invisible air vents. Glittering details such as the 'CraftedClarity' glass application made of handmade crystal glass refine the luxurious ambience.





TRUE GREATNESS KNOWS NO LIMITS.

Luxurious and flooded with light, the interior of the BMW 7 Series envelops its passengers with unprecedented generosity. The Sky Lounge panoramic glass sunroof extends the comfortable experience of space up to the sky and opens up unique views. Inimitable seating comfort and plenty of legroom leave nothing to be desired in the rear.



EXPERIENCE INNOVATION WITH ALL YOUR SENSES.

With the latest BMW iDrive generation, you can seamlessly continue your everyday digital life in the vehicle: interaction with the infotainment system and the Intelligent Personal Assistant is intuitive via the touch screen or voice control. For example, when individually designing your driving experience with My Modes. Whether sporty, efficient or balanced – depending on the mode selected, your BMW adapts the driving dynamics and interior and inspires you with a harmonious overall experience. This is enhanced by the fascinating sound of the Bowers & Wilkins Diamond Surround System, if you wish.









LET THE SHOW BEGIN.

The Rear-seat entertainment Experience with BMW Touch Command transforms the rear seats of your BMW 7 Series into a private lounge at the touch of a button. Immerse yourself in the expanse of the 31.3" BMW Theatre Screen and enjoy top-class entertainment. All functions are controlled directly on the multi-touch display. Or conveniently via the Touch Command displays in the doors. For maximum convenience, the doors of the BMW 7 Series open and close fully automatically, and let you choose how you want to activate entry into your world of experience – directly at the door, via the My BMW App, with the vehicle key, via the control display or via voice assistant.





FASCINATING FOR SEVEN GENERATIONS: THE 7.

IN 1977, A NEVER-BEFORE-SEEN
COMBINATION OF POWERFUL
DYNAMICS AND INNOVATIVE
MOTORISATION EMERGED IN
THE LUXURY CAR SEGMENT: THE
BMW 7 SERIES. TODAY, WE ARE
EXPERIENCING THE NEXT
INSTALMENT OF THIS MODERN
APPROACH – AND A NEW LEVEL
OF FUTURE-PROOF TECHNOLOGY.

TIME FOR SUSTAINABLE
PROGRESS. TIME FOR THE NEXT
GENERATION BMW 7 SERIES.





1994



2001



2008



2022



2015

MANY WORLDS – THE BEST FROM EACH.

With a powerful combustion engine, as an efficient plug-in hybrid, sporty M vehicle or with a electric drive: the BMW 7 Series meets all the demands you place on it. Whichever version you decide to choose: the elegant saloon impresses with excellent driving performance and electrifying dynamism.



Descriptions and illustrations include optional equipment.





EUPHORIA: UNLIMITED.

Pure driving pleasure: adaptive 2-axle air suspension and Integral Active Steering create an unparalleled driving experience characterised by maximum driving stability, manoeuvrability and dynamics. The Executive Drive Pro suspension control system actively compensates for unevenness on the road and minimises the forces acting on you when cornering – for maximum comfort in all seats. The driver assistance systems in the BMW 7 Series set new standards when it comes to progress. They provide support in all driving situations and offer maximum safety.

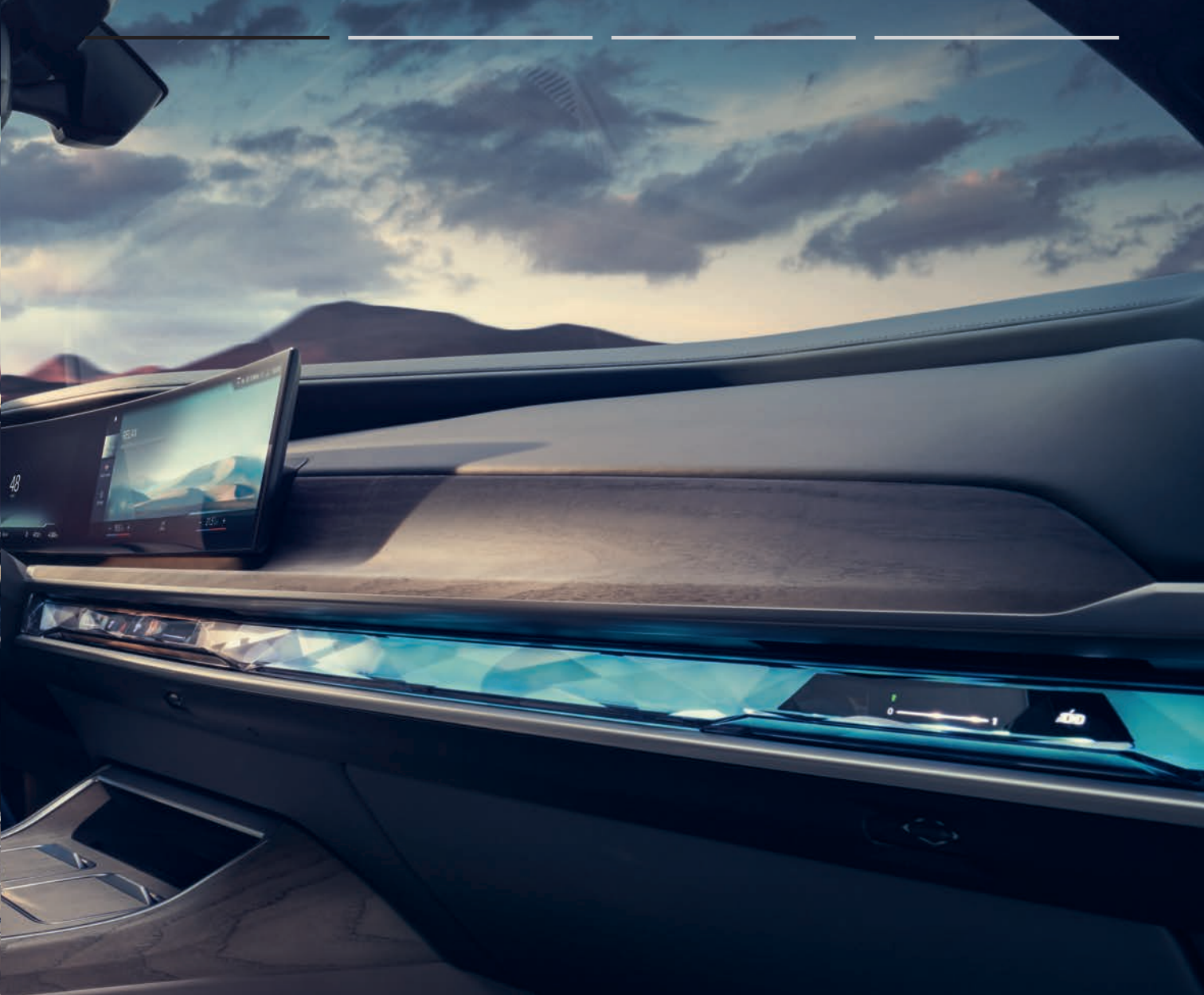



EASY CHARGING BOTH AT HOME AND ON THE MOVE.

With the optional Flexible Fast Charger, you can charge your electric BMW 7 Series safely and conveniently at any socket at home. And for even more convenient charging, simply expand your charging options with an intelligent BMW Wallbox if you wish. On the road, the BMW Charging card offers you access to a Europe-wide charging network. For fast public charging at attractive terms.

ON-BOARD CHARGING CONVENIENCE.

With BMW Charging, you can always charge easily, quickly and conveniently, even when you're out and about. The Mode 3 charging cable and the handy BMW Charging card come with the electric BMW 7 Series models. The BMW Charging network, has more than 200,000 charging stations available to you throughout Europe. And with the My BMW App, you can always find a charging station near you.



VEHICLE TYPES AT A GLANCE.

BASIC VERSION



M SPORT PACKAGE



Athletic and strong in character: the BMW 7 Series with M Sport package.

M SPORT PACKAGE PRO



Sporty driving pleasure de luxe: the BMW 7 Series with M Sport package Pro.

BMW PLUG-IN HYBRIDS



Two worlds in one with efficient dynamics: THE BMW 7 Series plug-in hybrid¹.

BMW ELECTRIC VEHICLE



Electrifying elegance: the BMW i7.

BMW M VEHICLE



The aesthetics of superiority: the BMW M760e.

VEHICLE TYPES.

740d xDrive

Transmission	8-speed, automatic
Cylinders/displacement, number/cm ³	6/2993
System power kW (hp)	220 (299) ¹

BMW PLUG-IN HYBRIDS / ELECTRIC VEHICLE

750e xDrive

i7 eDrive50

i7 xDrive60

Transmission	8-speed, automatic	1-speed, automatic	1-speed, automatic
Cylinders/displacement, number/cm ³	6/2998	-	-
System power kW (hp)	360 (490) ^{1,2}	335 (456)	400 (544)

BMW M VEHICLE

M760e xDrive

i7 M70 xDrive

Transmission	8-speed, automatic	1-speed, automatic
Cylinders/displacement, number/cm ³	6/2998	-
System power kW (hp)	420 (571) ^{1,2}	485 (660)

¹ Consists of combustion engine drive (specified nominal value) and electric drive (up to specified nominal value).

² Power dependent on the battery's state of charge.

SELECTED STANDARD EQUIPMENT.

You will find selected **standard equipment** for your vehicle here.

EXTERIOR

Extended exterior mirror package

With the extended exterior mirror package you can fold in the exterior mirrors electrically when parking your vehicle. This saves parking space and prevents damage. The automatic dimming function on the driver's side ensures that you are not dazzled by the headlights of vehicles behind you in the dark.

Adaptive LED Headlights

The Adaptive LED Headlights with matrix technology adapt automatically to the conditions – be it on the motorway or on country roads. Even in bad weather, you benefit from better visibility. For maximum range of vision: the headlight detects oncoming traffic as well as vehicles in front and automatically fades them out of the high-beam headlight.

Exterior items

The exterior features are carefully coordinated and underline the vehicle's presence. With the impressive kidney grille, your BMW is immediately recognisable as such from the front. Flush-fitting outside door handles, trim strips in high-gloss chrome and seamless transitions seen in the side view emphasise the elegant character.

INTERIOR

Fineline Brown lime wood open-pored fine-wood trim

'Fineline' Brown lime wood open-pored fine-wood interior trim

Veganza

Veganza KVRI Cognac, Veganza KVJY Black/Burgundy, Veganza KVMY Mocha & Veganza KVSW Black.

Floor mats in velour

The perfectly fitting floor mats in velour repel dirt and water, protect the carpet and are easy to clean.

Ambient lighting

With the ambient lighting, you can enjoy a relaxing, cosy lighting atmosphere in the interior while driving. The doors, centre console and footwells, among other things, are indirectly illuminated. On the outside, the dynamic Welcome Light Carpet welcomes you with a spectacular design sequence.

Panorama glass sunroof

Thanks to the large area of the panoramic glass sunroof, you can experience a special sense of space in your BMW: the glass surface extends continuously from the windscreen to the rear window and creates a friendly, light-flooded atmosphere. An electric roller blind for darkening supplements the glass sunroof.

CONNECTIVITY AND INFOTAINMENT

BMW Live Cockpit Plus

With BMW Live Cockpit Plus you get a large BMW Curved Display. It combines a fully digital 12.3" instrument display with a 14.9" touch-enabled control display. The integrated navigation gets you to your destination quickly and conveniently. The Intelligent Personal Assistant and smartphone integration increase operating convenience.

BMW iDrive

BMW iDrive seamlessly continues your everyday digital experience in the vehicle, in an advanced interior with intuitive-reach operating units. Interacting with your infotainment system via touchscreen and voice control is always straightforward and natural, for an integrated, smart and emotional experience. Always at the cutting edge.

BMW Interaction Bar

Crystalline glass look and dynamic lighting: the BMW Interaction Bar runs through the interior like a fine masterpiece – from the doors to the entire instrument panel. Look, feel and functionality are impressively combined. Various control panels and the almost invisible air vents are integrated.

BMW Touch Command

With BMW Touch Command you can control a host of comfort and infotainment functions in the rear seats – intuitively and conveniently accessible. The 5.5-inch TFT displays in the rear doors also serve as a touch-enabled remote control for the Rear Seat Entertainment. The displays automatically adapt to the selected My Mode.

Bowers & Wilkins Surround Sound System

Be it music or entertainment: with the Bowers & Wilkins Surround Sound System, you can enjoy a thrilling sound experience on the go. Pulse-compensated woofers in the doors deliver a balanced bass, while midrange speakers with Continuum technology ensure a clean midrange. Especially for the rear: additional speakers in the head restraints.

My Modes

Whether sporty, efficient or individual – My Modes create a harmonious vehicle experience. In the vehicle interior, the displays and light adapt to the mood for the respective mode. Corresponding vehicle handling completes your personal characteristics. Depending on the vehicle and equipment, up to seven different modes are available to choose from.

DRIVING DYNAMICS

Steptronic Sport transmission

The 8-speed Steptronic sport transmission allows you both comfortable sliding gear changes and a dynamic driving style with very sporty gear changes – automatically and also manually via shift paddles. In SPORT mode and when operating the electronic selector lever (switch: S/M), the gear shifts are configured for maximum performance.

Standard suspension

The adaptive standard suspension offers a high level of driving precision, agility and ride comfort. The prerequisites for this are provided by the two-axle ride level control in conjunction with Dynamic Damper Control at each wheel. At higher speeds, the suspension is also lowered by 10 mm and additionally stabilises your BMW.

Steering

The steering combines high driving dynamics with low steering effort. The system provides you with the appropriate steering assistance depending on the speed. This makes it easier for you to perform parking manoeuvres, and to keep safely in lane at high speed. Via My Modes you can choose between comfortable or sporty settings.

Adaptive 2-axle air suspension

With the standard adaptive 2-axle air suspension incl. automatic self-levelling suspension, you experience particularly comfortable driving combined with high driving dynamics. Together with the adaptive shock absorbers, the air suspension increases both comfort and vehicle handling. This means that you are more agile and safer on the road – especially with a full load.

DRIVER ASSISTANCE AND SAFETY

Parking Assistant

Parking Assistant makes it easier for you to park and manoeuvre in tight spaces. The Reversing Assist Camera, distance sensors and an emergency braking function prevent parking damage. In addition, your BMW recognises suitable parking spaces as you drive past and parks automatically if necessary. Practical: The Reversing Assistant supports you, for example, in narrow driveways.

Active Guard Basis

Active Guard combines helpful driver assistance systems: Front-collision warning and left turn warning, Evasion Assistant and Lane Departure Warning with lane return enhance driving safety. Speed Limit Display incl. anticipation and no-overtaking indicator and the Manual Speed Limit Assist help to avoid exceeding the speed limit.

Speed limiter

With the Manual Speed Limiter, you can set a maximum speed individually. This function is particularly convenient in countries with a general speed limit on motorways. If you want to drive faster for a short time, all you need to do is press the accelerator pedal more firmly.

Attentiveness Assistant

The Attentiveness Assistant checks your steering behaviour for signs of fatigue, such as inaccurate lane keeping. If the system detects anomalies, it responds: if necessary, a break recommendation will then appear in the control display in order to ideally prevent hazardous situations.

High-beam Assistant

High-beam headlight on, high-beam headlight off – oncoming traffic or vehicles in front of you need a lot of your attention at night. The High-beam Assistant takes the strain off you. It detects oncoming traffic as well as vehicles in front. If necessary, it automatically switches between dipped beam and high-beam headlights, allowing you to concentrate fully on the journey.

Cruise Control with brake function

The Cruise Control with brake function stores and maintains any selected speed above 30 km/h, even when going downhill. If necessary, an automatic brake intervention takes place. The function is conveniently operated via the multifunction steering wheel.

COMFORT AND FUNCTIONALITY

Standard seat for driver and front passenger

Standard seat for the two front seats with lumbar support, seat heating and electric seat adjustment incl. memory function also for exterior mirrors/steering column.

SELECTED STANDARD EQUIPMENT.

You will find selected **standard equipment** for your vehicle here.

Rear seats

Occupants enjoy maximum comfort on the three fully equipped rear seats. The centre armrest, the comfort cushion in the optional multifunction seat and the integrated head restraints create a comfortable lounge feeling on the outer seats. Three-point seat belts and ISOFIX child seat mountings increase safety.

Seat heating for driver and front passenger

Even before the engine has reached its running temperature, the seat heating for driver and front passenger provides pleasant warmth, adjustable in different intensity levels. The heating elements warm the seat cushion surface, the side sections, and the entire contact surface of the backrest – separately and as needed.

Seat adjustment, electric with memory

The electrical seat adjustment with memory function makes adjusting the driver's and front passenger's seats particularly comfortable and easy. The seat height, seat angle, seat position and the backrest angle can be adjusted. A particularly practical feature: the memory function allows you to save the settings for the driver's seat and exterior mirrors.

Air conditioning, automatic with 4-zone control

The automatic air conditioning with 4-zone control allows an individual climate comfort for you, the front passenger, as well as for the rear seat passengers. Convenient and practical: the rear seat passengers can control the temperature of their areas separately via their own control. A nanoparticle filter for fresh and recirculated air also improves the air quality.

Comfort Access

Save yourself the hassle of having to hold the vehicle key: with Comfort Access, your BMW unlocks the doors automatically. The vehicle recognises you from a distance by your key – you no longer have to search in your pockets. Instead of a classic key, you can also use a compatible smartphone as Digital Key Plus or the Key Card.

Soft-close function for doors

Comfortable and quiet: the soft-close function automatically pulls the slightly open door shut with no unpleasant noise. All you need to do is simply lean the door against the lock. The soft-close function closes and secures the door completely.

Storage options

The storage options in your BMW allow quick access to personal items. A variety of options are available to you: an electrically opening glove compartment, front and rear door pockets, storage compartments in the centre console, coat hooks and cup holders as well as a storage compartment in the front and rear armrests.

Automatic tailgate operation

The Automatic tailgate operation allows users to open and close the tailgate electrically – at the push of a button in the interior or on the vehicle key. It can also be opened using the tailgate button, and closed using a button on the inside of the tailgate. An acoustic warning signal increases safety.



BASIC VERSION.



Standard seat for the two front seats with lumbar support, seat heating and electric seat adjustment incl. memory function also for exterior mirrors/steering column.

The 2-spoke leather steering wheel with flatter bottom section incl. multifunction for comfortable operation has a particularly pleasant, high-grip feel.



19" light alloy aerodynamic wheels 904 Bicolour, wheel size 8.5J x 19 with 245/50 R19 tyres.



21" M light alloy aerodynamic wheels 909 M Multicolour 3D polished buff with mixed tyres (M760e xDrive/i7 M70 xDrive)

SELECTED BASE MODEL EXTERIOR EQUIPMENT FEATURES:

- Soft-close function for doors
- Panoramic glass sunroof (without opening function)
- Adaptive LED Headlights incl. High-beam Assistant and LED rear lights
- Automatic tailgate operation
- Comfort Access
- 19" light alloy aerodynamic wheels 904 Bicolour
- 21" M light alloy aerodynamic wheels 909 M Multicolour 3D polished buff with mixed tyres (M760e xDrive/i7 M70 xDrive)

SELECTED BASE MODEL INTERIOR EQUIPMENT FEATURES:

- BMW Live Cockpit Plus with BMW Curved Display
- BMW Operating System 8.5 with navigation
- BMW Interaction Bar in a crystalline glass look, backlit
- BMW Touch Command, control panels in the rear doors
- Bowers & Wilkins Surround Sound System
- BMW My Modes: PERSONAL, SPORT (incl. SPORT PLUS), EFFICIENT, EXPRESSIVE, RELAX, ART, THEATRE¹
- Driver's seat adjustment, electrical with memory, lumbar support
- Seat heating for driver and front passenger
- Air conditioning, automatic with 4-zone control
- Ambient interior lighting

¹ My Mode THEATRE only in conjunction with Rear Seat Entertainment Experience.

M SPORT PACKAGE.



The Multifunction seats for the two front seats offer extensive adjustment possibilities and exceptional seating comfort and safety.



With the M leather steering wheel incl. 12 o'clock marking and multifunction, you experience a sporty, direct steering feel.



21" M light alloy wheels Star-spoke style 908 M Bicolour Jet Black with mixed tyres, gloss-lathed, wheel size front 9J x 21 with 255/40 R21 tyres, wheel size rear 10.5J x 21 with 285/35 R21 tyres.



The powerful M Sport braking system¹ creates a visually striking highlight – with brake calipers painted in dark blue metallic and M inscription.

SELECTED M SPORT PACKAGE EXTERIOR EQUIPMENT RANGES:

- M Aerodynamics package with front and rear apron with diffuser insert in Dark Shadow metallic, lower section of side sills in high-gloss Black
- 20" M light alloy wheels 907 M Jet Black Gloss with mixed tyres (alternatively 21" M or BMW Individual light alloy wheels)
- M designation on the front side panels on the left and right in light Chrome
- M High-gloss Shadowline exterior trim

SELECTED M SPORT PACKAGE INTERIOR EQUIPMENT:

- M entry sills, M driver footrest and M specific pedals
- Multifunction seats for driver and front passenger
- M leather steering wheel with multifunction buttons
- Fineline interior trim in Black with metallic effect and M stripes; other trims available
- Vehicle key with exclusive M designation
- M-specific mode in FPK/CIC
- Optional at extra cost: various leather trims, M Sport braking system in Blue, M rear spoiler

¹ Available as optional equipment.

M SPORT PACKAGE PRO.

Appearance meets function: the M rear spoiler¹ lends your BMW a sporty touch and at the same time ensures even greater driving stability.



The powerful M Sport braking system² creates a visually striking highlight – with brake calipers painted in high-gloss black and M inscription.



The M high-gloss Shadowline exterior trim with extended elements gives your BMW an individual, subtly sporty look. The dark details extend from the front to the rear. The kidney grilles and inserts in the rear lights are in Black.

SELECTED M SPORT PACKAGE PRO EXTERIOR EQUIPMENT:

- M high-gloss Shadowline exterior trim with extended elements
- BMW radiator grille in high-gloss Black
- Black finishers in the rear bumper and in the rear lights
- M Sport braking system with brake calipers in Black high-gloss and M designation (optionally also available in Blue)
- 21" M light alloy wheels Styling 909M in Jet Black (all colour variants optionally available at no extra charge)
- Tailpipe trim elements in Black with typical M 4-pipe look (only for model variant M760e xDrive)
- M rear spoiler in Sapphire Black

¹ In combination with the M Sport package Pro and the M Performance package equipment, the rear spoiler is finished in Black metallic.

² Optional equipment; optionally available.

PLUG-IN HYBRID¹.



19" light alloy aerodynamic wheels 904 Bicolour, wheel size 8.5 J x 19 with 245/50 R19 tyres.



The fast charging cable (mode 3) allows you to charge the high-voltage battery at public charging stations – 3-phase and with a charging capacity of up to 7,4kW.



SELECTED PLUG-IN HYBRID EXTERIOR EQUIPMENT FEATURES:

- Soft-close function for doors
- Panoramic glass sunroof (without opening function)
- Adaptive LED Headlights incl. High-beam Assistant and LED rear lights
- Automatic tailgate operation
- Comfort Access
- 19" light alloy aerodynamic wheels 904 Bicolour, wheel size 8.5 J x 19 with 245/50 R19 tyres (750e xDrive)
- 21" M light alloy aerodynamic wheels 909 M Multicolour 3D polished buff with mixed tyres, wheel size 9 J x 21 with 255/40 R21 tyres / 10.5 J x 21 with 285/35 R21 (M760e xDrive)

SELECTED PLUG-IN HYBRID INTERIOR EQUIPMENT FEATURES:

- BMW Live Cockpit Plus with BMW Curved Display
- BMW Operating System 8.5 with navigation
- BMW Interaction Bar in a crystalline glass look, backlit
- BMW Touch Command, control panels in the rear doors
- Bowers & Wilkins Surround Sound System
- BMW My Modes: PERSONAL, SPORT (incl. SPORT PLUS), EFFICIENT, EXPRESSIVE, RELAX, ART, THEATRE²
- Driver's seat adjustment, electrical with memory, lumbar support
- Seat heating for driver and front passenger
- Air conditioning, automatic with 4-zone control
- Ambient interior lighting

¹ Vehicles illustrated show the M Sport package.

² My Mode THEATRE available only in conjunction with Rear-seat entertainment Experience with BMW Touch Command.

ELECTRIC VEHICLE.



Standard seat for the two front seats with lumbar support, seat heating and electric seat adjustment incl. memory function also for exterior mirrors/steering column.



The 2-spoke leather steering wheel with flatter bottom section incl. multifunction for comfortable operation has a particularly pleasant, high-grip feel.



19" light alloy aerodynamic wheels 904 Bicolour, wheel size 8.5J x 19 with 245/50 R19 tyres.



The fast charging cable (mode 3) allows you to charge the high-voltage battery at public charging stations – 3-phase and with a charging capacity of up to 22kW.

SELECTED i7 EXTERIOR EQUIPMENT RANGES:

- Soft-close function for doors
- Panoramic glass sunroof (without opening function)
- Adaptive LED Headlights incl. High-beam Assistant and LED rear lights
- Automatic tailgate operation
- Comfort Access
- Exterior trim, Chromeline¹
- 19" light alloy aerodynamic wheels 904 Bicolour, wheel size 8.5 J x 19 with 245/50 R19 tyres (i7 eDrive50/i7 xDrive60)
- 21" M light alloy aerodynamic wheels 909 M Multicolour 3D polished buff with mixed tyres, wheel size 9 J x 21 with 255/40 R21 tyres / 10.5 J x 21 with 285/35 R21 (i7 M70 xDrive)

SELECTED i7 INTERIOR EQUIPMENT RANGES:

- BMW Live Cockpit Plus with BMW Curved Display
- BMW Operating System 8.5 with navigation
- BMW Interaction Bar in a crystalline glass look, backlit
- BMW Touch Command, control panels in the rear doors
- Bowers & Wilkins Surround Sound System
- BMW My Modes: PERSONAL, SPORT (incl. SPORT PLUS), EFFICIENT, EXPRESSIVE, RELAX, ART, THEATRE¹
- BMW IconicSounds Electric
- Driver's seat adjustment, electrical with memory, lumbar support
- Seat heating for driver and front passenger
- Air conditioning, automatic with 4-zone control
- Climate pre-temperature setting
- Ambient interior lighting
- Comfort seats with synthetic, leather-free Veganza material

¹ My Mode THEATRE available only in conjunction with Rear-seat entertainment Experience with BMW Touch Command.

The availability of some equipment features, functions and digital services depends on engine versions or additional optional equipment. The offer structure as well as market

and production availability may vary. For detailed information about availabilities, duration and costs, contact your local BMW authorised workshop.

M VEHICLE.



The Multifunction seats for the two front seats offer extensive adjustment possibilities and exceptional seating comfort and safety.



With the M leather steering wheel incl. 12 o'clock marking and multifunction, you experience a sporty, direct steering feel.



21" M aerodynamic wheels 909 M Multicolour Jet Black 3D buffed with mixed tyres, gloss-lathed, wheel size front 9J x 21 with 255/40 R21 tyres, wheel size rear 10.5J x 21 with 285/35 R21 tyres.

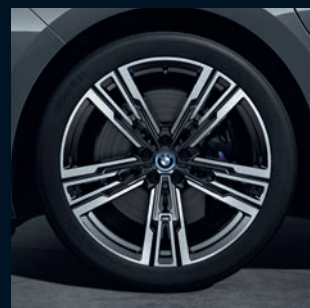

21" M light alloy wheels Star-spoke style 908 M Bicolour Jet Black with mixed tyres, gloss-lathed, wheel size front 9J x 21 with 255/40 R21 tyres, wheel size rear 10.5J x 21 with 285/35 R21 tyres.¹



The powerful M Sport braking system creates a visually striking highlight – with brake calipers painted in dark blue metallic and M inscription.

SELECTED M VEHICLE EXTERIOR EQUIPMENT RANGES:

- M High-gloss Shadowline exterior trim
- Radiator grille with M badge
- M side elements
- M exterior mirrors in Black
- M exhaust system with 4 visible tailpipe trims
- M Sport braking system, Dark Blue metallic
- 21" M aerodynamic wheels 909M
- M rear spoiler

¹ Available as optional equipment.



EQUIPMENT HIGHLIGHTS.

Discover select standard and optional equipment highlights. Optional equipment shown is not included in the basic price.



Visual highlight on the exterior: contour line lighting impressively showcases the BMW kidney "Iconic Glow" – both when the vehicle is at a standstill or while driving. LED elements feed a fibre-optic conductor integrated into the kidney frame, which evenly highlights the kidney outlines. When deactivated, the technology is not visible.



The BMW crystal headlights Iconic Glow give your BMW an unmistakable appearance, whether at a standstill or while driving.



The Exterior trim, Chromeline¹ lends your BMW a particularly refined look with the M Sport package. Details in high-gloss chrome adorn the side window graphics and side sills, for example.

¹ Only available with M Sport package. Not available in conjunction with M high-gloss Shadowline exterior trim with extended elements.

The availability of some equipment features, functions and digital services depends on engine versions or additional optional equipment. The offer structure as well as market and production availability may vary. For detailed information about availabilities, duration and costs, contact your local BMW authorised workshop.

EQUIPMENT HIGHLIGHTS.

Discover select standard and optional equipment highlights. Optional equipment shown is not included in the basic price.



The 'CraftedClarity' glass application for interior elements enhances your interior with handmade crystal glass.

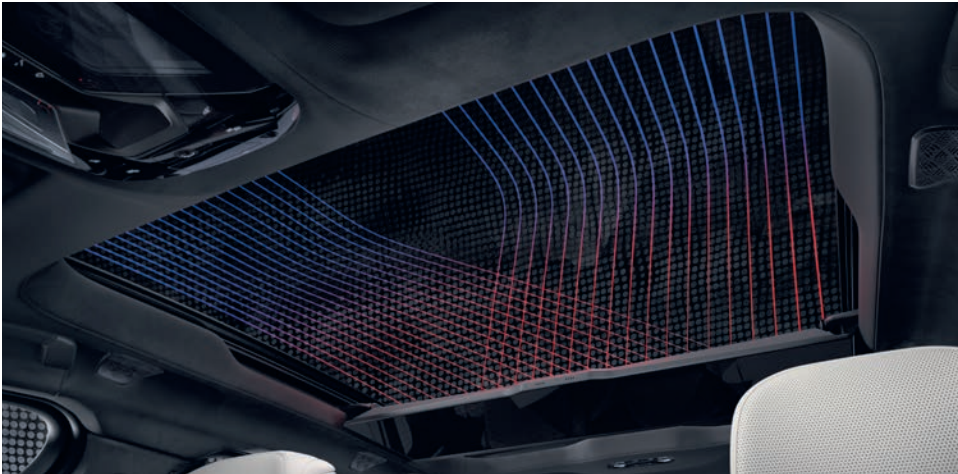

Enjoy exclusive sportiness: the M Alcantara anthracite headliner with matching sun visors, parcel shelf and body pillars gives your interior a particularly high-quality look and also improves your noise comfort.



With the ambient lighting, you can enjoy a relaxing, cosy lighting atmosphere in the interior while driving. The doors, centre console and footwells, among other things, are indirectly illuminated. On the outside, the dynamic Welcome Light Carpet welcomes you with a spectacular design sequence.

With the BMW Individual interior you can make the interior of your BMW even more exclusive. The fine-wood trim High-Gloss Oak in Grey Metallic high-gloss, the BMW Individual Merino leather in Black and the M anthracite headliner create a luxurious impression. Multifunction seats for you and your front passenger offer extensive adjustment possibilities.



The BMW Individual interior with exclusive elements creates a luxurious interior. Components: BMW Individual Merino leather / wool-cashmere combination with exclusive Black / Grey items. Multifunction seats for you and your front passenger offer extensive adjustment possibilities.

The M Sport interior adds a sporty touch in the interior – thanks to the M anthracite headliner and the black M interior trim with high-gloss metal effect. Added convenience: the multifunction seats for you and your front passenger offer extensive adjustment possibilities. All seats are also exclusively available in two-tone M leather 'Merino'.

The availability of some equipment features, functions and digital services depends on engine versions or additional optional equipment. The offer structure as well as market and production availability may vary. For detailed information about availabilities, duration and costs, contact your local BMW authorised workshop.

EQUIPMENT HIGHLIGHTS.

Discover select standard and optional equipment highlights. Optional equipment shown is not included in the basic price.



More order, more comfort: With the wireless charging tray, you can charge your smartphone wirelessly and thus extremely conveniently.



Whether navigation or smartphone integration² – the digital services of the Connected Package Professional³ leave nothing to be desired.



Reach your destination even more comfortably and safely: BMW Live Cockpit Professional adds more useful functions to BMW Live Cockpit Plus. The Head-up display¹ projects driving-relevant information directly into your field of view. Augmented View vividly displays instructions given by the navigation system in a live video image of the real environment.



Whether sporty, efficient or individual – My Modes create a harmonious vehicle experience. In the vehicle interior, the displays and light adapt to the mood for the respective mode. Corresponding vehicle handling completes your personal characteristics. Depending on the vehicle and equipment, up to seven different modes are available to choose from.

¹ The information in the BMW Head-Up Display is not fully visible when viewed through polarised sunglasses.

² Smartphone integration is not compatible with all smartphones and apps.

³ Smartphone integration is permanently available in the vehicle. The online functions for Maps Connected Navigation each have a three year term. These can be extended at the end of the term in the BMW ConnectedDrive Store. To use optional equipment other optional equipment may be necessary. Due to possible future technical developments (e.g. of mobile phones), the usability of the Apple CarPlay or the Google Android Auto services cannot be guaranteed in the long term. CarPlay is a trademark of Apple Inc. Android Auto is a trademark of Google LLC.

The availability of some equipment features, functions and digital services depends on engine versions or additional optional equipment. The offer structure as well as market and production availability may vary. For detailed information about availabilities, duration and costs, contact your local BMW authorised workshop.

EQUIPMENT HIGHLIGHTS.

Discover select standard and optional equipment highlights. Optional equipment shown is not included in the basic price.



The Bowers & Wilkins Diamond surround sound system with 1,965-watt output provides an exclusive sound for all seats. This is made possible by diamond tweeters, which can be found in only the highest quality studio speakers. 36² perfectly tuned speakers incl. eight head restraint speakers generate fascinating surround sound.

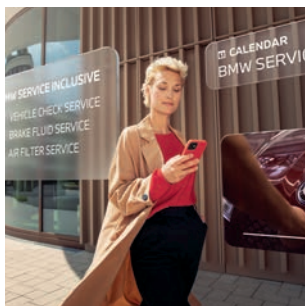

Smart, up-to-date, and sophisticated: with its contemporary design and intuitive user prompting, the My BMW App accompanies you through a whole new mobility experience. Plan your next trip, check the status of your BMW, book your next service appointment or use one of the numerous remote control functions – all conveniently from your smartphone.



The Rear-seat entertainment Experience creates a unique cinematic experience in the rear seats. The 31,3" BMW Theatre Screen, which can be used with Amazon FireTV¹, provides top-class entertainment – whether streaming services, social media or games. Operation takes place directly via multitouch or conveniently via the Touch Command in the rear doors.



BMW Individual Gran Lusso interior including ambient light.

¹ The Amazon FireTV offer and the apps it contains vary from country to country. To use the apps offered on Amazon FireTV, the customer requires a separate account, which may be subject to a charge, depending on the service. As an alternative to Amazon FireTV, the optional equipment in China includes the Huawei App Store.

² Electric vehicles and plug-in hybrids are equipped with 35 speakers.

The availability of some equipment features, functions and digital services depends on engine versions or additional optional equipment. The offer structure as well as market and production availability may vary. For detailed information about availabilities, duration and costs, contact your local BMW authorised workshop.

EQUIPMENT HIGHLIGHTS.

Discover select standard and optional equipment highlights. Optional equipment shown is not included in the basic price.



The Multifunction seats for the two front seats offer extensive adjustment possibilities and exceptional seating comfort and safety.



As a rear passenger, the multifunction seats offer you extensive adjustment options for a high level of seating comfort.



Sit back and enjoy: Executive Lounge Seating offers you as a rear passenger a comfortable resting position behind the front passenger seat.



The massage function for the front seats enhances your physical well-being through targeted stimulation or relaxation of the muscles.

Thanks to front and rear seat heating, you can control the temperature of the seat cushions and backrests of the front and outer rear seats – individually for each seat.



Functional yet sophisticated: the Executive Lounge rear console impresses with a high-quality glass surface and a practical folding function.

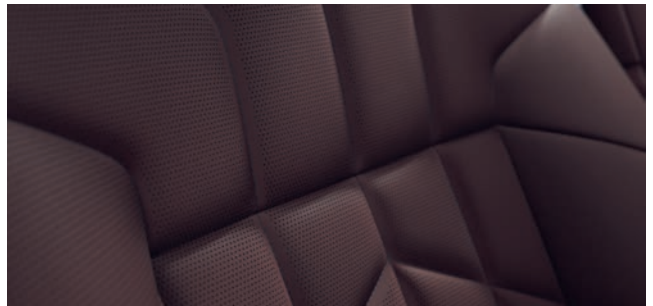

The massage function for rear-seat passengers helps improve the level of well-being of rear seat passengers by stimulating or relaxing muscles in a targeted manner.

The availability of some equipment features, functions and digital services depends on engine versions or additional optional equipment. The offer structure as well as market and production availability may vary. For detailed information about availabilities, duration and costs, contact your local BMW authorised workshop.

EQUIPMENT HIGHLIGHTS.

Discover select standard and optional equipment highlights. Optional equipment shown is not included in the basic price.



More comfort in hot weather: with the front active seat ventilation¹, you enjoy a cool and pleasant seating experience.



More comfort in hot weather: with the rear active seat ventilation², you as the rear seat passenger can enjoy a cool and pleasant seating experience.



The Sky Lounge panoramic glass sunroof creates a generous sense of space. Thanks to LED-based light design, you can enjoy a captivating atmosphere.



The Sun protection glazing for the rear window and tinted rear side windows reduces unwanted warming of the interior.



Thanks to the innovative panel heating, you can enjoy cosy warmth particularly quickly and efficiently with the Heat Comfort package³.



The automatic air conditioning with 4-zone control allows individual climate comfort for you, the front passenger, as well as for the right and left rear passengers.



The automatic doors with locking and collision protection enable you to open and close all doors extremely conveniently and fully automatically.

¹ Only in conjunction with multifunction seats for driver and front passenger. Only in conjunction with seat heating for driver and front passenger or the Heat Comfort package, front.

² Only with front active seat ventilation. Only with front and rear seat heating or the Heat Comfort package, front and rear.

³ Applies only to left-hand drive vehicles; right-hand drive vehicles without panel heating in the vehicle cockpit.

The availability of some equipment features, functions and digital services depends on engine versions or additional optional equipment. The offer structure as well as market and production availability may vary. For detailed information about availabilities, duration and costs, contact your local BMW authorised workshop.

EQUIPMENT HIGHLIGHTS.

Discover select standard and optional equipment highlights. Optional equipment shown is not included in the basic price.



With Remote Engine Start, you can start the engine conveniently from a distance and thus heat or cool the interior before setting off. The offer structure as well as market and production availability may vary.

Mild hybrid technology saves you fuel by recovering brake energy. The system also assists the combustion engine during acceleration.

BMW xDrive all-wheel drive system: Enjoy extra traction, driving dynamics and driving safety.

The 8-speed Steptronic sport transmission allows you both comfortable sliding gear changes and a very dynamic driving style with very sporty gear changes.



With Executive Drive Pro, you can enjoy particularly comfortable or sporty driving. The chassis control system actively compensates for road unevenness. It also minimises the forces acting on you when cornering. You will experience an outstanding driving experience in every situation.

With the standard adaptive 2-axle air suspension incl. self-levelling suspension, you will also experience exceptional ride comfort and high driving dynamics.

Integral Active Steering provides you with greater manoeuvrability and agility when parking, for example. Driving stability increases at higher speeds.

The availability of some equipment features, functions and digital services depends on engine versions or additional optional equipment. The offer structure as well as market and production availability may vary. For detailed information about availabilities, duration and costs, contact your local BMW authorised workshop.

EQUIPMENT HIGHLIGHTS.

Discover select standard and optional equipment highlights. Optional equipment shown is not included in the basic price.



Active Protection is a preventive occupant safety function that takes safety precautions for you and your passengers in the event of an impending accident. The system brings the electric seats into an upright position and closes the windows. This enables Active Protection to reduce the risk of injury.

Whether it's an imminent frontal collision or rear-end cross-traffic – Driving Assistant¹ warns and brakes independently if necessary. It helps to prevent accidents when changing lanes and getting out of the car. It also warns following traffic of an impending rear-end collision. The system can also reduce the risk of exceeding speed limits.

Enjoy more relaxed travel with Driving Assistant Plus². Especially on longer journeys, it takes the strain off you by automatically maintaining the desired speed, lane and distance from the vehicle ahead and braking in an emergency. It also warns of speed limits or no-overtaking signs.



A real all-rounder: The Driving Assistant Professional¹ not only maintains the desired speed and distance to the vehicle in front, but also keeps your BMW on track by steering interventions. This relieves the strain, especially on longer journeys. Other functions help you avoid collisions and exceeding the speed limit.

A better view when parking and manoeuvring: Parking Assistant Plus³ supplements the standard Park Distance Control with additional cameras. Thanks to the panoramic and 3D view of the vehicle's surroundings, you can manoeuvre effortlessly even in tight spaces. This prevents parking damage and accidents in unclear situations.

The Parking Assistant Professional³ can – in addition to Parking Assistant Plus – park your BMW without a driver on board. It automatically repeats a manoeuvre that you have previously performed yourself. All you have to do is monitor it up close – either by key or smartphone.

¹ Function may be restricted in darkness, fog or bright glare.

² Activation of the optional equipment can be added at a later date via Functions on Demand in conjunction with the equipment package "Driving Assistant Plus preparation". You can find information and offers for Functions on Demand via the My BMW App as well as online or directly in the vehicle via the BMW Shop.

³ The driver is responsible for constantly monitoring the automated parking manoeuvre in accordance with local road traffic regulations.

The availability of some equipment features, functions and digital services depends on engine versions or additional optional equipment. The offer structure as well as market and production availability may vary. For detailed information about availabilities, duration and costs, contact your local BMW authorised workshop.

EQUIPMENT HIGHLIGHTS. M VEHICLE.



The M Performance package rounds off your BMW in terms of sporting character – with trim parts in Black such as the M Sport braking system and the M rear spoiler.



BMW M exterior mirror, black



Radiator grille with BMW M logo



BMW M side elements



The powerful M Sport braking system with dark blue metallic-painted brake calipers and M inscription creates a striking highlight. With a four-piston fixed caliper at the front and a single-piston floating caliper at the rear, you can rely on outstanding braking performance – even in an emphatically sporty driving style and in wet conditions.

The availability of some equipment features, functions and digital services depends on engine versions or additional optional equipment. The offer structure as well as market and production availability may vary. For detailed information about availabilities, duration and costs, contact your local BMW authorised workshop.

WHEELS AND TYRES.

20" M aerodynamic wheels 907 M Bicolour Jet Black with mixed tyres, gloss-lathed, wheel size front 9J x 20 with 255/45 R20 tyres, wheel size rear 10.5J x 20 with 285/40 R20 tyres.



21" M light alloy wheels Star-spoke style 908 M Bicolour Jet Black with mixed tyres, gloss-lathed, wheel size front 9J x 21 with 255/40 R21 tyres, wheel size rear 10.5J x 21 with 285/35 R21 tyres.



19" aerodynamic wheels 904 Bicolour Dark Grey, gloss-lathed, wheel size 8.5J x 19 with 245/50 R19 tyres.⁴



20" light alloy wheels Star-spoke style 905 Bicolour Black Grey with mixed tyres, gloss-lathed, wheel size front 9J x 20 with 255/45 R20 tyres, wheel size rear 10.5J x 20 with 285/40 R20 tyres.⁴



20" aerodynamic wheels 906 Bicolour Dark Grey 3D buffed with mixed tyres, gloss-lathed, wheel size front 9J x 20 with 255/45 R20 tyres, wheel size rear 10.5J x 20 with 285/40 R20 tyres.⁴



21" M aerodynamic wheels 909 M Multicolour Jet Black 3D buffed with mixed tyres, gloss-lathed, wheel size front 9J x 21 with 255/40 R21 tyres, wheel size rear 10.5J x 21 with 285/35 R21 tyres.²



21" M aerodynamic wheels 909 M Multicolour 3D buffed with mixed tyres, gloss-lathed, wheel size front 9J x 21 with 255/40 R21 tyres, wheel size rear 10.5J x 21 with 285/35 R21 tyres.³



21" BMW Individual aerodynamic wheels 910 Multicolour Dark Grey 3D buffed with mixed tyres, gloss-lathed, wheel size front 9J x 21 with 255/40 R21 tyres, wheel size rear 10.5J x 21 with 285/35 R21 tyres.³

¹ Standard equipment.

² Standard equipment for the M760e xDrive/i7 M70 xDrive.

³ Only available in conjunction with M Vehicles.

⁴ Not available in conjunction with M Sport, M Sport package Pro and M Vehicle.

The availability of some equipment features, functions and digital services depends on engine versions or additional optional equipment. The offer structure as well as market and production availability may vary. For detailed information about availabilities, duration and costs, contact your local BMW authorised workshop.

EXTERIOR COLOUR WORLD.

EXTERIOR COLOURS



Non-metallic 300 Alpine White¹



Metallic A96 Mineral White

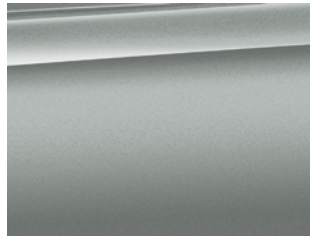

Metallic C67 Space Silver²

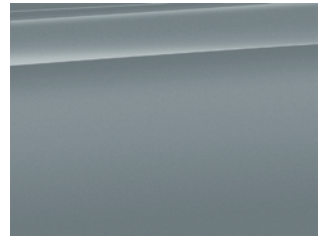

Metallic C4P M Brooklyn Grey³

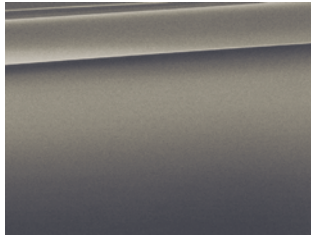

Metallic C4A Oxide Grey metallic

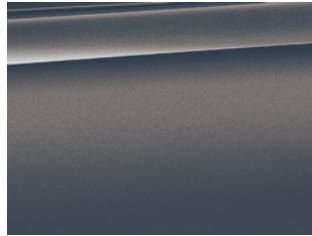

Metallic C55 Sparkling Copper Brown²

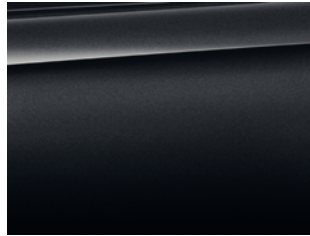

Metallic A90 Sophisto Grey Brilliant Effect²

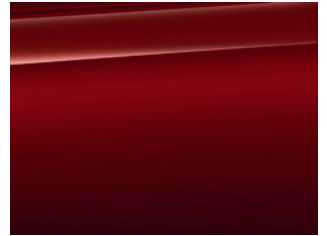

Metallic C57 Aventurine Red

BMW INDIVIDUAL



Metallic 416 M Carbon Black



Metallic 475 Black Sapphire

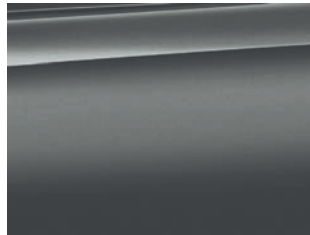

BMW Individual C5A Frozen Pure Grey metallic²



BMW Individual C36 Dravit Grey metallic



BMW Individual C64 Frozen Deep Grey metallic

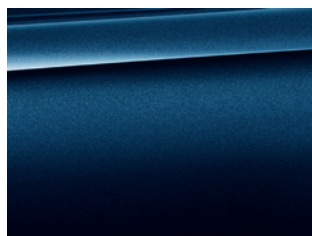

BMW Individual C3Z Tanzanite Blue metallic



BMW Individual X1G Frozen Tanzanite Blue metallic⁴

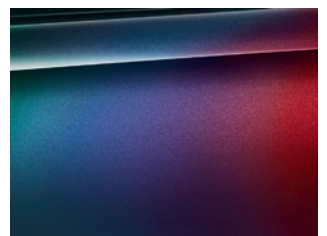

BMW Individual 490 special paintwork (up to 150 paints available)⁴

[Colour samples] These colour samples are intended as an initial guide to the colours and materials available for your BMW. However, experience has shown that printed versions of paint, upholstery and interior trim colours cannot in all cases faithfully reproduce the appearance of the original colour. Please discuss your preferred colour choices with your BMW partner or in your dealership. There you can also see original samples and be assisted with special requests.



Make an individual statement. BMW Individual special paintwork offers you countless possibilities to highlight the exclusivity of your BMW 7 Series. Simply scan the QR code or ask your Authorised BMW Retailer.

¹ Standard equipment.

² Not available in conjunction with M Sport package or M Vehicle.

³ Only in conjunction with M Sport package or M Vehicle.

The availability of some equipment features, functions and digital services depends on engine versions or additional optional equipment. The offer structure as well as market and production availability may vary. For detailed information about availabilities, duration and costs, contact your local BMW authorised workshop.

EXTERIOR COLOUR WORLD. TWO-TONE.

EXTERIOR COLOURS

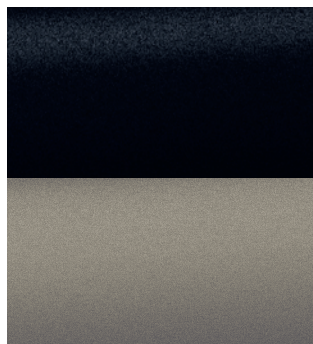

Metallic 475 Black Sapphire /
Metallic C4A Oxide Grey metallic



Metallic 475 Black Sapphire /
Metallic C57 Aventurine Red

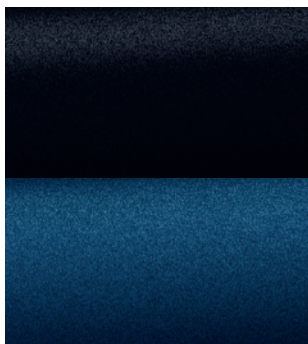

Metallic 475 Black Sapphire / BMW
Individual C3Z Tanzanite Blue
metallic

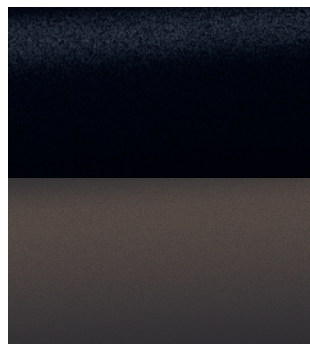

Metallic 475 Black Sapphire / BMW
Individual C36 Dravit Grey metallic

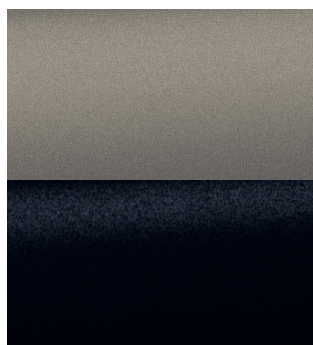

Metallic C4A Oxide Grey metallic /
Metallic 475 Black Sapphire

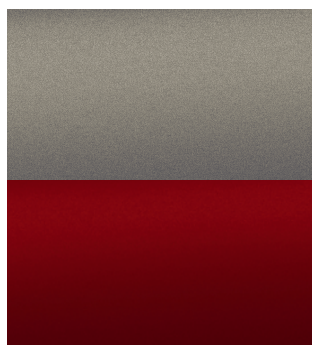

Metallic C4A Oxide Grey metallic /
Metallic C57 Aventurine Red

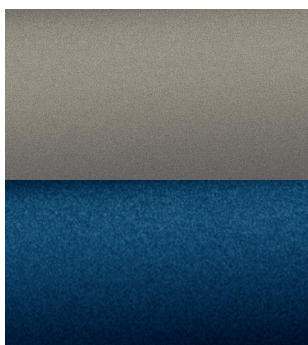

Metallic C4A Oxide Grey metallic /
BMW Individual C3Z Tanzanite Blue
metallic

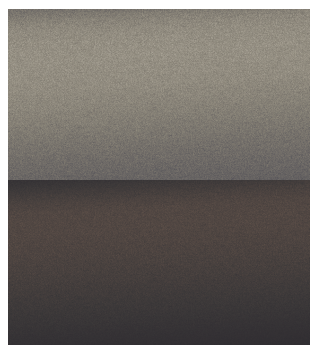

Metallic C4A Oxide Grey metallic /
BMW Individual C36 Dravit Grey
metallic

[Colour samples] These colour samples are intended as an initial guide to the colours and materials available for your BMW. However, experience has shown that printed versions of paint, upholstery and interior trim colours cannot in all cases faithfully reproduce the appearance of the original colour. Please discuss your preferred colour choices with your BMW partner or in your dealership. There you can also see original samples and be assisted with special requests.

The availability of some equipment features, functions and digital services depends on engine versions or additional optional equipment. The offer structure as well as market and production availability may vary. For detailed information about availabilities, duration and costs, contact your local BMW authorised workshop.

INTERIOR COLOURS.

Exclusive upholstery enhances your interior. Integrated in the overall interior colour scheme, exquisite leathers ensure perfect elegance.

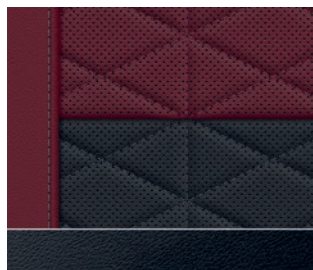

Veganza KVJY Black/Burgundy^{1,2}

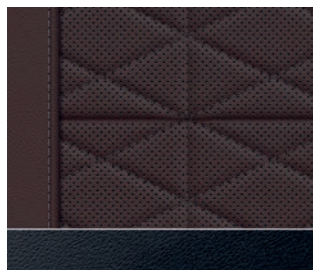

Veganza KVJY Mocha^{1,2}



Veganza KVRI Cognac^{1,2}

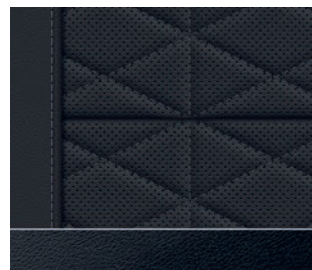

Veganza KVSW black^{1,2}

BMW INDIVIDUAL

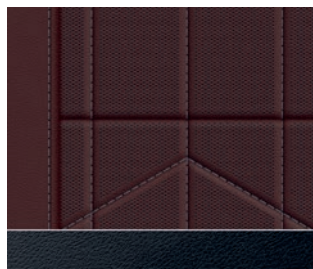

BMW Individual Merino leather
VCF2 Amarone²

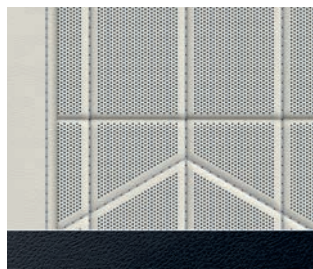

BMW Individual Merino leather
VCFU Smoke White²

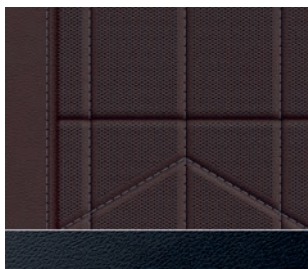

BMW Individual Merino leather
VCMY Mocha²

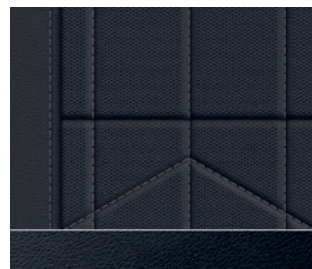

BMW Individual Merino leather
VCSW Black²



BMW Individual Merino leather
VCTQ Tartufo²



BMW Individual Merino leather
VDFZ Amarone with exclusive
items³

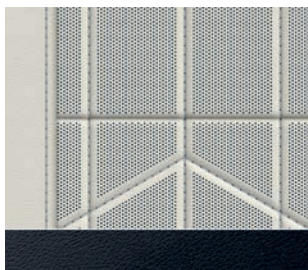

BMW Individual Merino leather
VDFU Smoke White with exclusive
items²



BMW Individual Merino leather
VDMY Mocha with exclusive items²

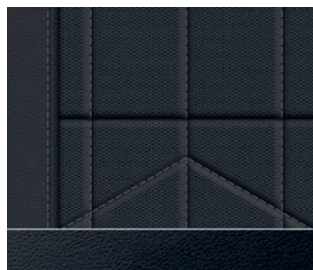

BMW Individual Merino leather
VDSW Black with exclusive items²

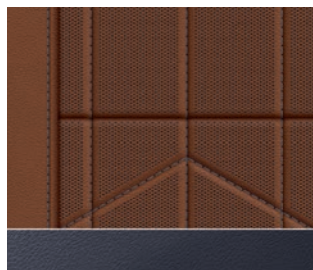

BMW Individual Merino leather
VDTQ Tartufo with exclusive items³

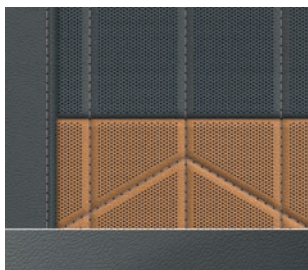

BMW Individual Merino leather ZDIE
Caramel / Atlas Grey with exclusive
items⁴



BMW Individual Merino leather ZDIF
Taupe Grey / Night Blue with
exclusive items³

¹ Standard equipment.

² In conjunction with world colour Black.

³ In conjunction with world colour Night Blue.

⁴ In conjunction with world colour Grey.

The availability of some equipment features, functions and digital services depends on engine versions or additional optional equipment. The offer structure as well as market and production availability may vary. For detailed information about availabilities, duration and costs, contact your local BMW authorised workshop.

INTERIOR COLOURS.

Exclusive upholstery enhances your interior. Integrated in the overall interior colour scheme, exquisite leathers ensure perfect elegance.

BMW INDIVIDUAL

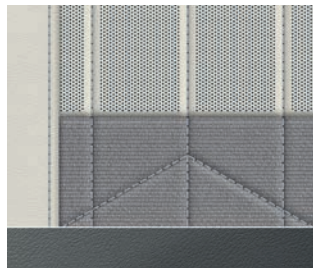

BMW Individual Merino leather / wool-cashmere combination with exclusive VEIL Smoke White/Light Grey elements¹

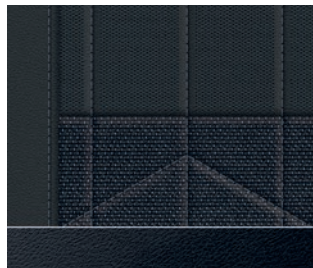

BMW Individual Merino leather / wool-cashmere combination ZETM with exclusive Black / Grey elements²

M MERINO LEATHER



M Merino leather VCJL Black / Atlas Grey²

INTERIOR TRIM



'Fineline' Brown lime wood open-pored fine-wood interior trim

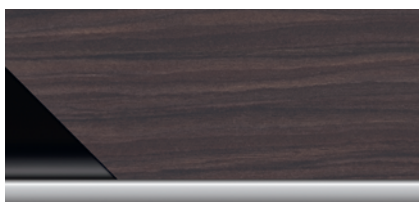

Fineline Lime Brown, open-pored/piano finish Black, fine-wood trim interior trim³



Fine-wood interior trim finishers High-Gloss Oak in Grey Metallic high-gloss

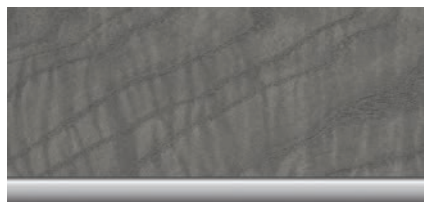

Fine-wood interior trim finishers Ash Grain Grey Metallic open-pore

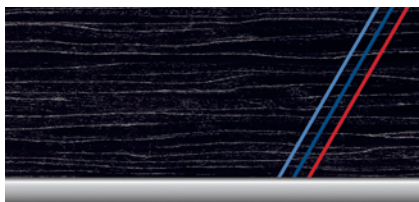

Fine-wood interior trim finishers 'Fineline' Black with metal effect high-gloss, M signature^{4,5}



Carbon Fibre M interior trim with silver threads/Piano Finish Black

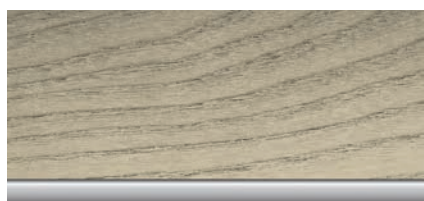

BMW Individual Ash Flowing Grey, open-pored, fine-wood trim interior trim⁵

¹ In conjunction with world colour Grey.

² In conjunction with world colour Black.

³ Standard equipment.

⁴ Standard equipment for the M760e xDrive/i7 M70 xDrive.

⁵ Only in conjunction with BMW Individual Merino leather/wool-cashmere combination with exclusive Smoke White/Light Grey elements VEIL.

The availability of some equipment features, functions and digital services depends on engine versions or additional optional equipment. The offer structure as well as market and production availability may vary. For detailed information about availabilities, duration and costs, contact your local BMW authorised workshop.



ORIGINAL BMW ACCESSORIES.

Intensive driving experiences, even further enhanced: Original BMW accessories are the best match for an original BMW. Whether you're looking for wheels and tyres, transport and luggage compartment solutions, interior equipment, communication, information and technology, charging accessories or M performance parts, with genuine BMW accessories you'll find exactly the individual solution that will allow you to discover driving pleasure as if for the first time.



WHEELS AND TYRES.

With original BMW complete wheels, you'll reach your destination safely, and emphasise the sporty appearance of your BMW from the very first glance. But what you don't immediately realise is that they are precisely tailored to your BMW, are subject to very stringent tests with intensive material and function checks, and have been developed in close collaboration with leading tyre manufacturers – individually tuned to the driving dynamics and design language of each individual BMW model.

TRANSPORT AND LUGGAGE COMPARTMENT SOLUTIONS.

Original BMW Accessories offer you a wide range of transport and luggage compartment solutions. In line with your personal preferences and interests, you can use them to create additional space whenever and wherever you need it. Whether carrier systems or accessories for the luggage compartment, you can always rely on original BMW accessories to be precisely tailored to your BMW, and easy to use.



INTERIOR ACCESSORIES.

A perfect fit: all original BMW accessory products for the interior help to design the interior of your BMW to fully meet your personal preferences. In addition to the excellent functionality of original BMW accessories, you are also always choosing attractive BMW design alongside extraordinary craftsmanship and material quality – combined with an ambience that will excite you every time you drive.



COMMUNICATION, INFORMATION AND TECHNOLOGY.

Cutting-edge functions and features for maximum freedom and flexibility: Original BMW accessories for communication, information and technology are always at your side. Whether you value optimum availability by phone or the best sound, the innovative original BMW accessories will have the right solution for you. You'll always enjoy a good connection and custom entertainment, wherever your journey takes you.

CHARGING ACCESSORIES.

Regardless of where and how you want to charge your new BMW, original BMW charging accessories offer you tailor-made products and services. You can charge your BMW at any domestic socket using the BMW Flexible Fast Charger or, for even more convenience, at a BMW Wallbox from original BMW accessories; what's more, there's also a widespread network of public charging points available for when you're on the road. Innovative Connected Charging services show charging stations in your BMW's information display, for example, or enable you to easily start pre-conditioning your vehicle just using your smartphone.



M PERFORMANCE PARTS.

With M performance parts, you can experience BMW's motorsport DNA with fascinating intensity, even off the racetrack. A wide range of technical and visual components makes outstanding technology a visible and tangible experience. Exclusive materials and first-rate quality guarantee flawless dynamism. Experience inspiring maximum product performance: individual, expressive and uncompromising.

The availability of the equipment shown and described may vary on a market-specific basis. Your local BMW partner will be happy to advise you on the full range of original BMW accessories.

Discover the whole range of original BMW accessories and the BMW M performance parts product portfolio.



TECHNICAL VALUES.

BMW 7er		740d xDrive ^{6,7,8}	750e xDrive ^{6,7,9}	i7 eDrive50	i7 xDrive60 ¹
Complete vehicle drive system²					
Drive system type		Diesel - 48 Volt Mild Hybrid	Petrol – plug-in hybrid	full electric	full electric
Power	kW (hp)	220 (299) ¹²	360 (490) ^{12,13}	335 (455)	400 (544)
Torque	Nm	670 ¹²	700	650	745
Transmission		8-speed, automatic	8-speed, automatic	1-speed, automatic	1-speed, automatic
Drive type		All-wheel drive	All-wheel drive	Rear-wheel drive	All-wheel drive
BMW TwinPower Turbo engine²					
Cylinders		6	6	–	–
Capacity	cm ³	2993	2998	–	–
Rated output	kW (hp)/rpm	210 (286) / 4000	230 (313) / 5000–6500	–	–
Rated torque	Nm/rpm	650 / 1750–3000	450 / 1750–4700	–	–
Electric motor⁵					
(Nominal) output / 30 minutes output ¹¹	kW (hp)	13 (18) / – ⁷	145 (197)	335 (455) / 125 (170)	400 (544) / 135 (184)
(Rated) torque	Nm	200	280	650	745
Driving performance					
Acceleration 0–100 km/h	s	6.3	4.9	5.5	4.7
Top speed	km/h	250	250	205	240
Top speed (electric)	km/h	–	140	205	240
Consumption / CO₂ emissions^{2,3}					
Fuel consumption, combined WLTP ¹⁴	l/100 km	6.9–5.9	1.1–1.0	–	–
CO ₂ emissions, combined WLTP	g/km	182–157	25–22	–	–
Consumption, electrical, combined WLTP	kWh/100 km	–	20,8–19,7	20.3–19.1	19.6–18.4
Electric range WLTP ⁴	km	–	87–83	575–611	591–625
High-voltage/48-volt battery, charging¹⁰					
Battery size	kWh	1	21	101,7	101,7
Maximum charging power AC / DC	kW	–	7,4 / –	22 / 195	22 / 195
Charging time DC 10–80 %	h	–	–	0:34	0:34
Recharged range after 10 minutes of high-power charging	km	–	–	up to 170	up to 170
Charging time AC 0–100 %	h	–	approx. 03:00	05:30	05:30
Dimensions/weight					
Length / width / height	mm	5391 / 1950 / 1553	5391 / 1950 / 1544	5391 / 1950 / 1544	5391 / 1950 / 1544
Wheelbase	mm	3215	3215	3215	3215
Unladen weight ¹	kg	2255	2455	2595	2715
Luggage capacity	l	540	525	500	500
Fuel tank capacity	l	74	65	–	–
Trailer load optionally braked ex works up to 12 % / trailer load	kg	2100 / 85	2000 / 80	–	2000 / 80

The figures for performance, fuel consumption and CO₂ emissions refer to vehicles with standard transmission.

¹ The EC unladen weight refers to a vehicle with standard equipment and does not include any optional extras. The unladen weight includes a 90 % full tank and a driver weight of 75 kg. Optional equipment may affect the weight of the vehicle, the payload and the top speed if the selected equipment has an impact on the vehicle's aerodynamics.

² Performance data of petrol engines apply to vehicles using RON 98 fuel. Fuel consumption data apply to vehicles using reference fuels in accordance with EU Regulation 2007/715. Unleaded RON 91 and higher with a maximum ethanol content of 10 % (E10) may also be used. BMW recommends RON 95 super unleaded petrol.

³ Official data for fuel consumption, carbon dioxide emissions, power consumption and electric range was determined in accordance with the measuring procedures described and complies with European Regulation (EU) 715/2007 in the applicable version. In the event of ranges, data determined as per WLTP takes into account any optional equipment (available on the German market in this case). For vehicles that have been newly type approved since 1 January 2021, only the official data according to WLTP exist. For more information about NEDC and WLTP measuring procedures visit www.bmw.com/wltp

⁴ Range depends on various factors, in particular: individual driving style, route characteristics, outside temperature, heating/air conditioning, pre-conditioning.

⁵ At temperatures below freezing, the fully electric drive system on this plug-in hybrid is only available after a few kilometres of driving, once the battery has heated to operational temperature.

⁶ This engine version is not available in all countries. For further information, please contact your local BMW authorised workshop.

⁷ Provisional figures; any missing figures were unavailable at the time of publication.

⁸ Available from 12/2022.

⁹ Available from 03/2023.

¹⁰ Charging times/rate specified under optimal conditions (29–33 degrees Celsius battery start and ambient temperature with certification values excluding additional auxiliary consumers such as seat heating, displays, air conditioning).

¹¹ Continuous power BEV 30 minutes.

¹² Consists of combustion engine drive (specified nominal value) and electric drive (up to specified nominal value).

¹³ Power dependent on the battery's state of charge.

¹⁴ For plug-in hybrid: Weighted, combined (EC AC Charge Weighted).

TECHNICAL VALUES.

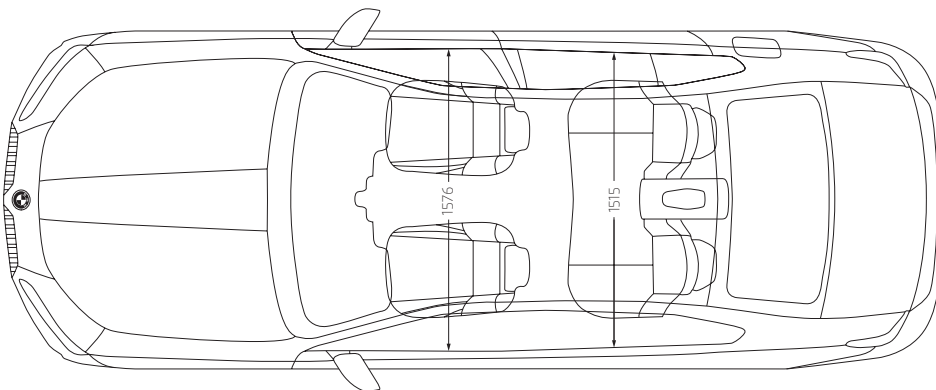
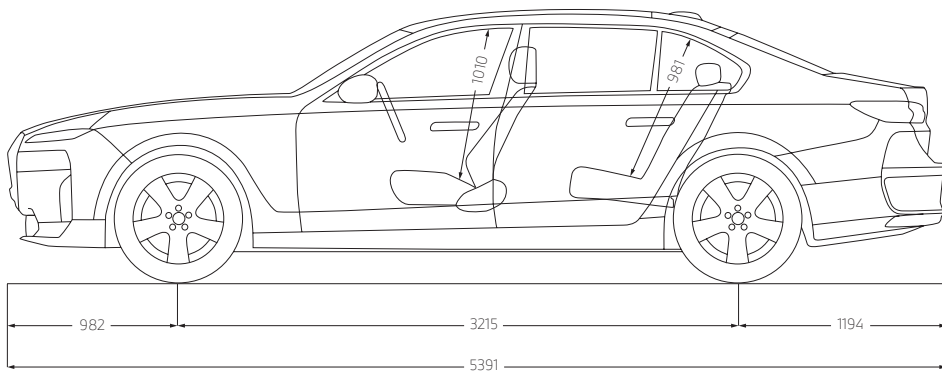
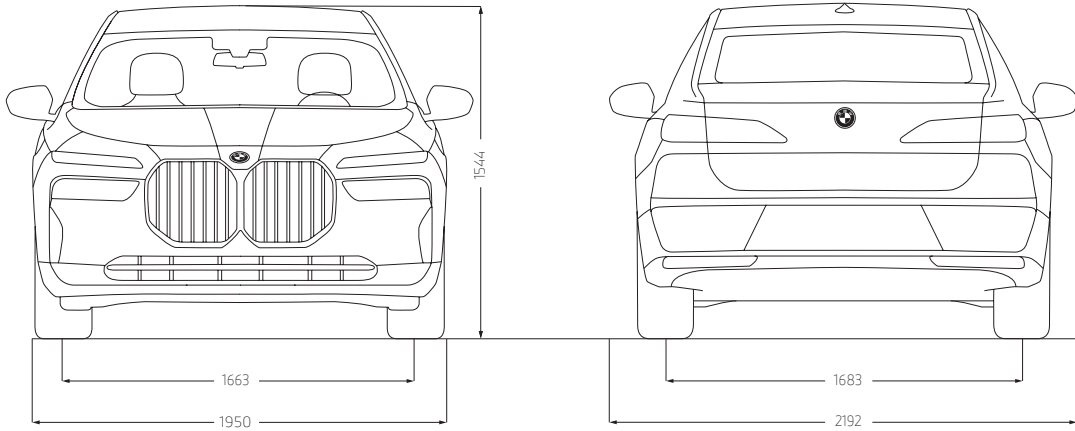

BMW CHARGING.



CHARGING.

Convenient, fast and safe charging – your BMW makes this possible via the charging socket on the side of the vehicle. The charging power socket for electric vehicles can be found on the right of the vehicle at the rear, and for Plug-in Hybrid Electric Vehicles at the front on the left.

Comfort functions make operation easier: in the dark, the search light in the charging power socket ensures that you can easily plug in the charging cable. Everything in view: the LED display of the charging power socket informs you of the current battery charge in various colours.

A temperature sensor also increases safety. It measures the temperature at the plug-in contacts and can detect potential overheating at an early stage.

The charging power socket locks and unlocks the charging plug automatically during the charging process so that it cannot be removed. If the charging plug can no longer be disconnected from the vehicle, the electrical emergency release helps in an emergency.

To keep the waiting time at AC charging stations to a minimum, you can recharge your electric vehicle there with a charging capacity of up to 22 kW. The high-voltage battery can be charged even faster at DC charging stations. Here you benefit from a charging capacity of up to 195 kW. Plug-in Hybrid Electric Vehicles, on the other hand, charge at AC charging stations with up to 7.4 kW as standard.



CHARGING AT HOME.

Charging at home is particularly easy with the optional Flexible Fast Charger. It can be used to charge your BMW 7 Series plug-in hybrid or your BMW i7 from any domestic or industrial plug socket, depending on your individual charging infrastructure. A Wallbox is an even faster, more convenient way of charging. BMW offers different Wallboxes for this purpose – including an installation service on request.

BMW CHARGING.



PUBLIC CHARGING.

Regardless of where you are and what you are planning – you can go anywhere you want to go with your BMW electric vehicle. A fast charging cable (mode 3) is also supplied with your plug-in hybrid or all-electric BMW for hassle-free charging on the move. The BMW Charging card is also included in the scope of delivery. This gives you access to a constantly growing network of public charging stations from various operators in inner cities as well as along important European traffic transit routes. Simply use BMW Maps in your vehicle or the My BMW App on your smartphone to find nearby charging stations.



BMW CONNECTED CHARGING.

With the Connected Charging digital services, you use the range of your BMW i model efficiently while remaining flexible at all times. The system assists you in the search for public charging stations and provides important information in advance. The app also gives you an overview of relevant vehicle data.

TECHNICAL VALUES M VEHICLE.

BMW 7er		M760e xDrive ^{6,7,8}	i7 M70 xDrive
Complete vehicle drive system²			
Drive system type		Petrol – plug-in hybrid	Full electric
Power	kW (hp)	420 (571) ^{11,12}	485 (660)
Torque	Nm	800	1015
Transmission		8-speed, automatic	1-speed, automatic
Drive type		All-wheel drive	All-wheel drive
BMW TwinPower Turbo engine²			
Cylinders		6	–
Capacity	cm ³	2998	–
Rated output	kW (PS)/1/min	280 (381) / 5200 – 6250	–
Rated torque	Nm/1/min	520 / 1850 – 5000	–
Electric motor⁵			
(Nominal) output / 30 minutes output ¹⁰	kW (PS)	145 (197)	485 (660)
(Rated) torque	Nm	280	1015
Driving performance			
Acceleration 0 – 100 km/h	s	4,3	3,7
Top speed	km/h	250	250
Top speed (electric)	km/h	140	250
Consumption / CO₂ emissions^{2,3}			
Fuel consumption, combined WLTP ¹³	l/100 km	1.3 – 1.0	–
CO ₂ emissions, combined WLTP	g/km	29 – 23	–
Consumption, electrical, combined WLTP	kWh/100 km	26.0 – 23.8	23.7 – 20.8
Electric range WLTP ⁴	km	84 – 77	559 – 490
High-voltage/48-volt battery, charging⁹			
Battery size	kWh	21	101,7
Maximum charging power AC / DC	kW	7,4 / –	22 / 195
Charging time DC 10 – 80 %	h	–	0:34
Recharged range after 10 minutes of high-power charging	km	–	up to 170
Charging time AC 0 – 100 %	h	approx. 03:00	05:30
Dimensions/weight			
Length / width / height	mm	5391 / 1950 / 1544	5391 / 1950 / 1544
Wheelbase	mm	3215	3215
Unladen weight ¹	kg	2525	2770
Luggage capacity	l	525	500
Fuel tank capacity	l	65	–
Trailer load optionally braked ex works up to 12 % / trailer load	kg	2000 / 80	–

The figures for performance, fuel consumption and CO₂ emissions refer to vehicles with standard transmission.

¹ The EC unladen weight refers to a vehicle with standard equipment and does not include any optional extras. The unladen weight includes a 90 % full tank and a driver weight of 75 kg. Optional equipment may affect the weight of the vehicle, the payload and the top speed if the selected equipment has an impact on the vehicle's aerodynamics.

² Performance data of petrol engines apply to vehicles using RON 98 fuel. Fuel consumption data apply to vehicles using reference fuels in accordance with EU Regulation 2007/715. Unleaded RON 91 and higher with a maximum ethanol content of 10 % (E10) may also be used. BMW recommends RON 95 super unleaded petrol.

³ Official data for fuel consumption, carbon dioxide emissions, power consumption and electric range was determined in accordance with the measuring procedures described and complies with European Regulation (EU) 715/2007 in the applicable version. In the event of ranges, data determined as per WLTP takes into account any optional equipment (available on the German market in this case). For vehicles that have been newly type approved since 1 January 2021, only the official data according to WLTP exist. For more information about NEDC and WLTP measuring procedures visit www.bmw.com/wltp

⁴ Range depends on various factors, in particular: individual driving style, route characteristics, outside temperature, heating/air conditioning, pre-conditioning.

⁵ At temperatures below freezing, the fully electric drive system on this plug-in hybrid is only available after a few kilometres of driving, once the battery has heated to operational temperature.

⁶ This engine version is not available in all countries. For further information, please contact your local BMW authorised workshop.

⁷ Provisional figures; any missing figures were unavailable at the time of publication.

⁸ Available from 03/2023.

⁹ Charging times/rate specified under optimal conditions (29 – 33 degrees Celsius battery start and ambient temperature with certification values excluding additional auxiliary consumers such as seat heating, displays, air conditioning).

¹⁰ Continuous power BEV 30 minutes.

¹¹ Consists of combustion engine drive (specified nominal value) and electric drive (up to specified nominal value).

¹² Power dependent on the battery's state of charge.

¹³ For plug-in hybrid: Weighted, combined (EC AC Charge Weighted).

TECHNICAL VALUES M VEHICLE.

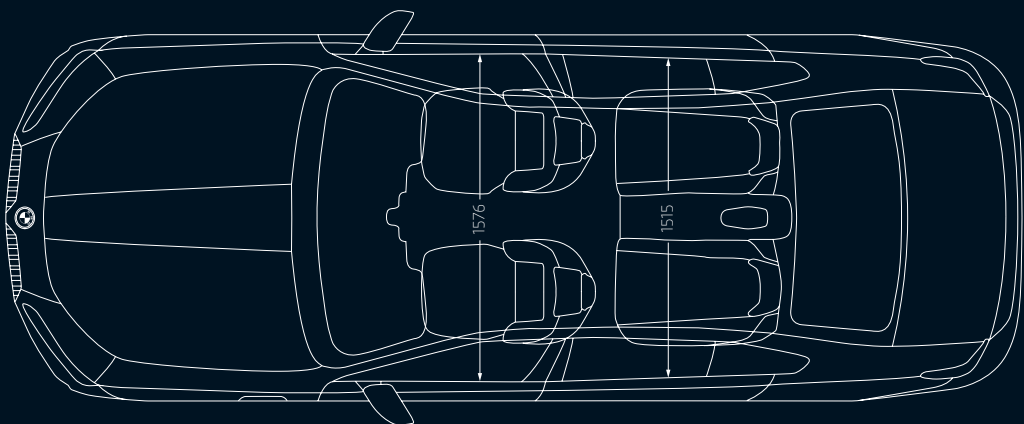
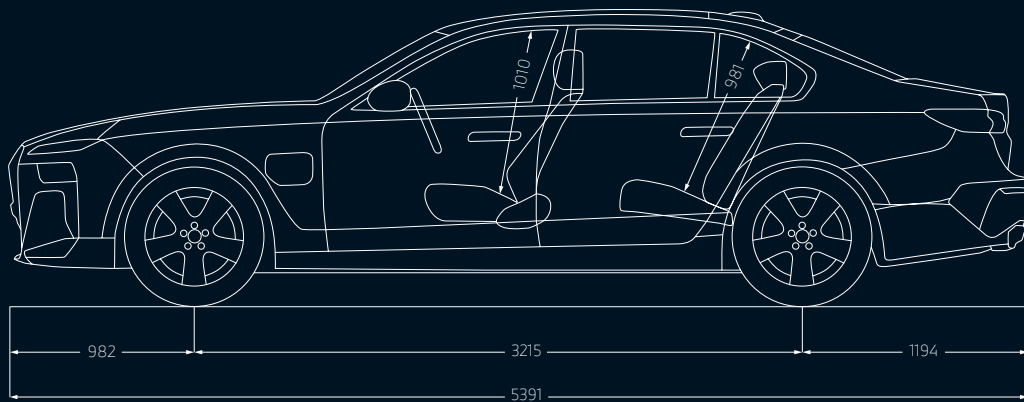
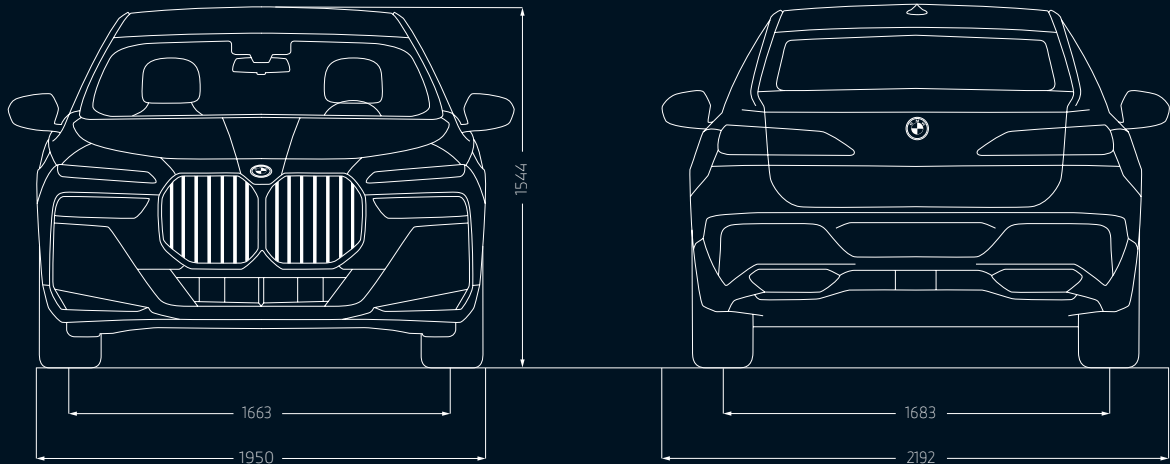



BMW SERVICE.



Always there for you: Your BMW Service Partner is there for helpful, expert support for everything to do with your BMW. Our aim is to make every journey in your BMW as pleasant as possible. A major worldwide network of workshops offers premium service from BMW specialists, innovative diagnostic technologies, and rapid availability of precisely fitting original BMW parts as well as original BMW engine oil. There are many great reasons to choose services from BMW, but there's one that really stands out: that driving pleasure that sets your BMW apart from the crowd will be yours to enjoy for many years to come with BMW Service.

WHEREVER, WHENEVER: OUR COMPREHENSIVE SERVICE.

Many BMW services can be easily booked and tracked online – so you can use your time for the really important things in life. Stay independent and flexible with online appointments and remote services. Take advantage of our innovative digital products and services such as online video advice, and get all the relevant information on your smartphone. And if you don't want to stop but have no choice, our BMW Breakdown and Accident Assistance service will help.



SUSTAINABILITY.

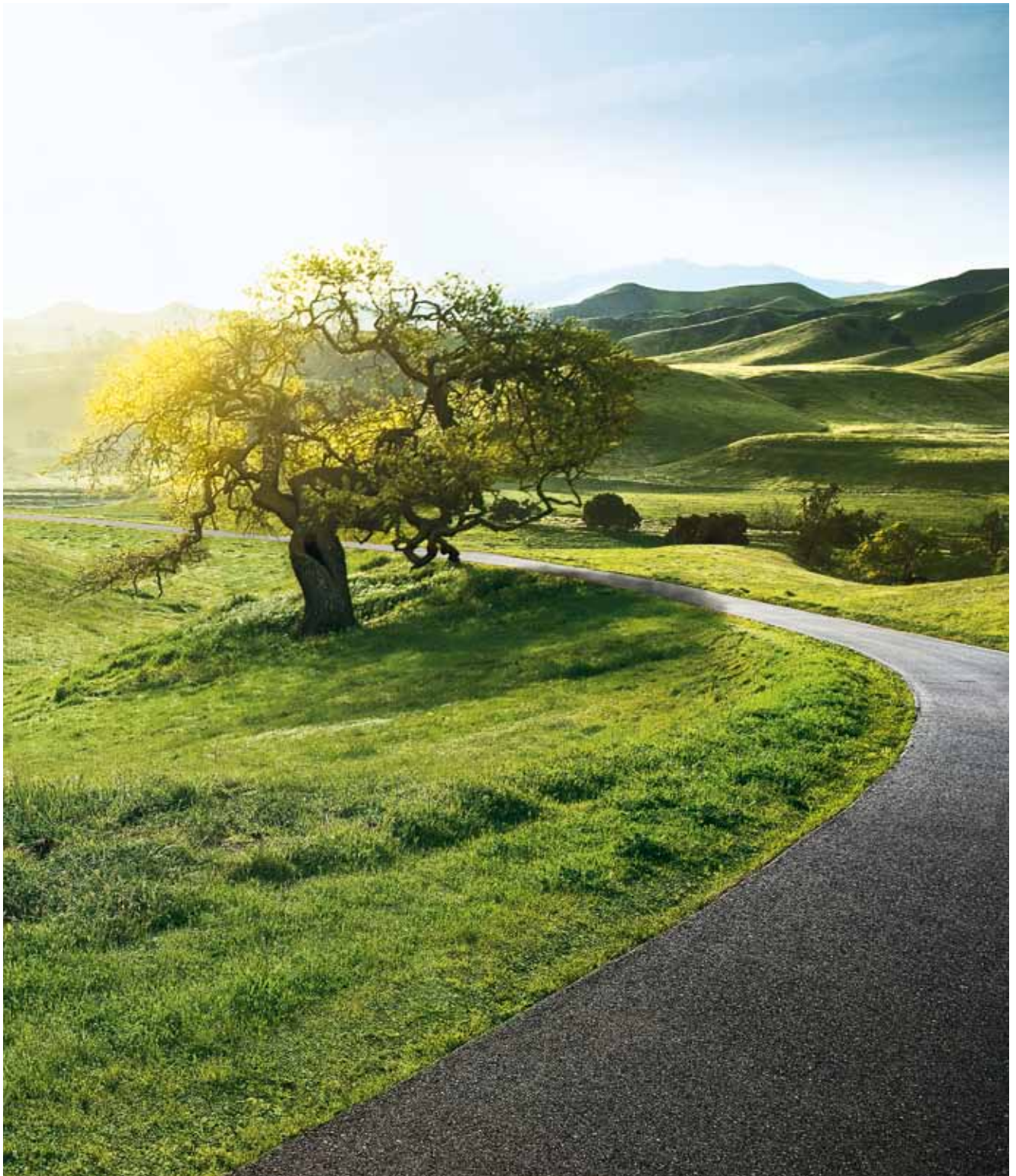

The BMW Group has been finishing at the top end of independent ratings and rankings that assess sustainability for a long time. These successes and increasing challenges in protecting the world we live in encourage us to embed sustainability as a key aspect in our corporate strategy. The development of efficient vehicle concepts, the establishment of eco-friendly production processes and the implementation of sustainable processes at our suppliers is part of our philosophy. Efficiency-enhancing technologies such as BMW EfficientDynamics and consistent electrification have enabled us to cut the CO₂ emissions of our fleet of vehicles in Europe by 50 %

between 1995 and 2020. In addition, between 2006 and 2020 we have reduced the consumption of water by 31% and the consumption of energy in production by 38 %. Our plants worldwide use green electricity only. Since 2021 our plants have even been producing completely carbon neutrally. And, of course, each of our vehicles is designed for easy or economical recycling after its long-running life. Please contact your BMW partner on all matters regarding your end-of-life vehicle. For more information on this issue please visit our website.

Of course, each vehicle is designed for economical recycling after its long-running life. You can find more information regarding your end-of-life vehicle on our website.

©2024 BMW Czech Republic s.r.o. Not to be reproduced wholly or in part without prior written permission.